

CARDIOVASCULAR

CATALOGUE



Cardiovascular

1- Scissors.....	01 - 29
2- Needle Holders.....	30 - 43
3- Forceps.....	44 - 51
4- Titanium Forceps and Clamps	52 - 62
5- Forceps and Clamps.....	61 - 72
6- Vascular Clamps.....	73 - 154
7- Bulldog and Micro Vessel Clamps.....	155 - 163
8- Vessel Instruments	164 - 166
9- Specialty CV/Thoracic Instruments and Retractors.....	167 - 180
10- Retractors.....	181 - 190
11- Rib Spreaders.....	191 - 205

Cardiovascular Scissors

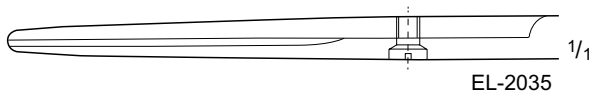
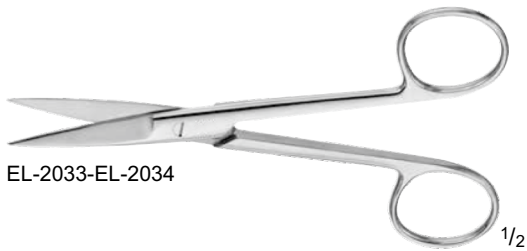
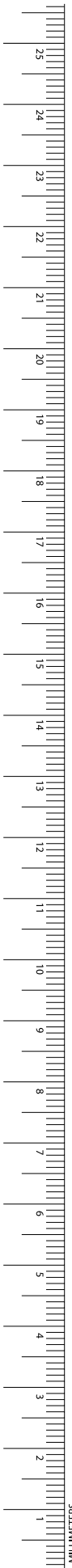

Vessel Scissors

Catalog Number	Tip	Blade	Length (in.)
EL-2032	B/B	1-PROBE-PT	5 3/4

MAYO Operating Scissors

Catalog Number	Tip	Blade	Length (in.)
EL-2033	S/S	STR	5 1/2
EL-2034	S/S	CVD	5 1/2

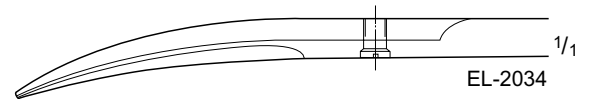

MAYO SuperCut Scissors, Delicate

Catalog Number	Tip	Blade	Length (in.)
EL-2035	B/B	STR	6 1/2
EL-2036	B/B	CVD	6 1/2



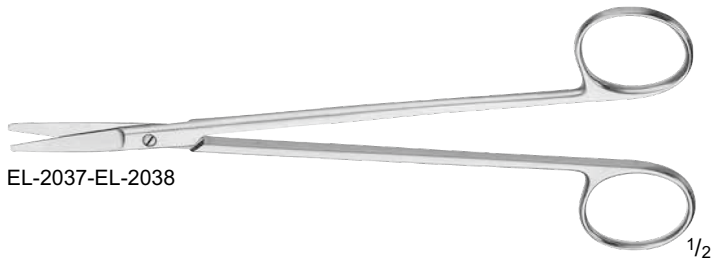

EL-2037-EL-2038

1/2

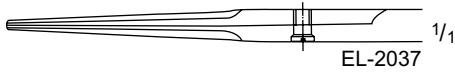

EL-2037

1/1



EL-2038

1/1

CHURCH Scissors, Beveled

Catalog Number	Tip	Blade	Length (in.)
EL-2037	B/B	STR	7
EL-2038	B/B	CVD	7

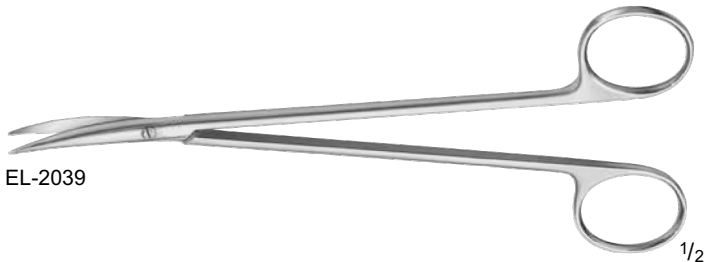

EL-2039

1/2

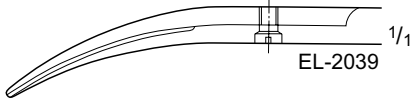

EL-2039

1/1

DEBAKEY Arteriotomy Scissors

Catalog Number	Tip	Blade	Length (in.)
EL-2039	B/B	CVD	6 7/8

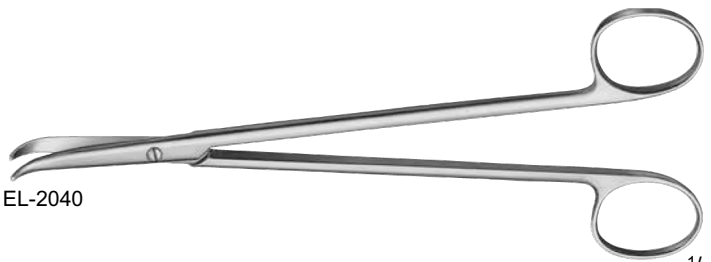

EL-2040

1/2

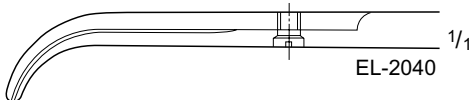

EL-2040

1/1

THOREK Scissors

Catalog Number	Tip	Blade	Length (in.)
EL-2040	B/B	HEAVY-CVD	7

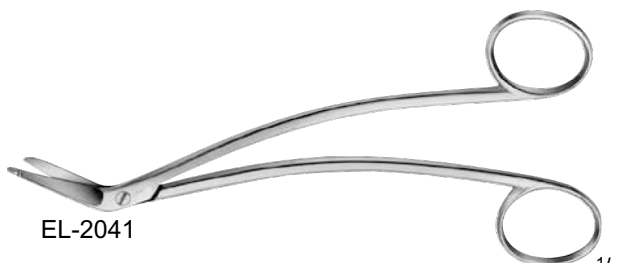

EL-2041

1/2

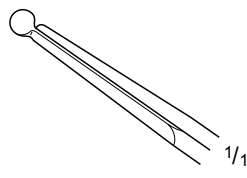

EL-2041

1/1

SCHMIEDEN-TAYLOR Dura Scissors

Catalog Number	Tip	Blade	Length (in.)
EL-2041	1BALL-PT	ANG	6 1/8

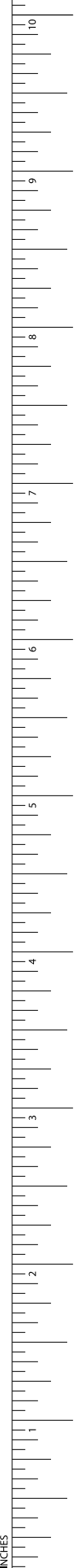

Cardiovascular Scissors

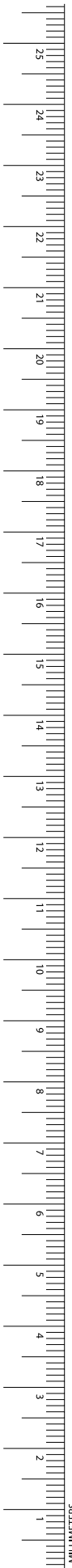

SATINSKY Vena Cava Scissors

Catalog Number	Blade	Length (in.)
EL-2042	CVD	9 5/8

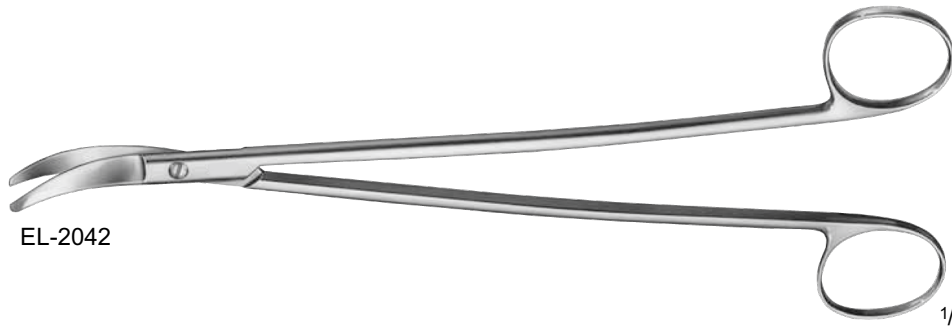

EL-2042

1/2

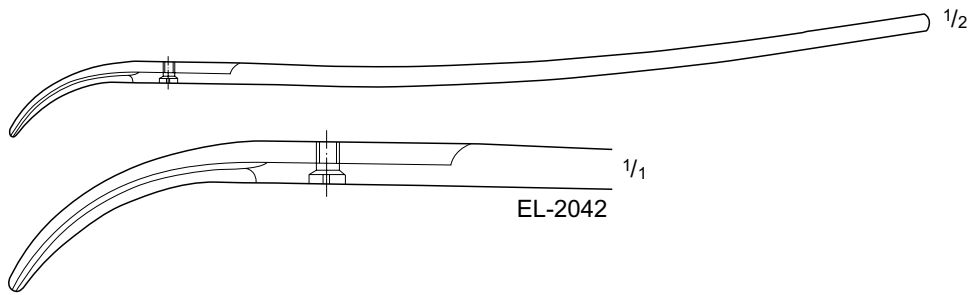

EL-2042

STRULLY Scissors

Catalog Number	Tip	Blade	Length (in.)
EL-2043	S/S	CVD	8 3/4

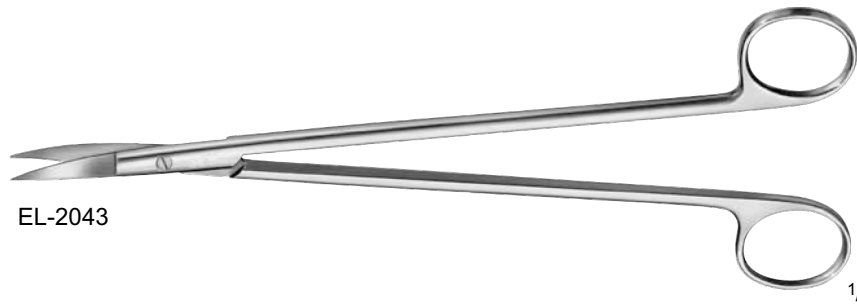

EL-2043

1/2

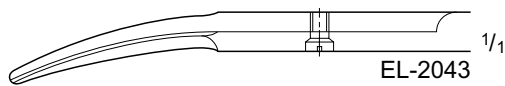

EL-2043

STRULLY Scissors

Catalog Number	Tip	Blade	Length (in.)
EL-2044	PROBE	CVD	8 3/4

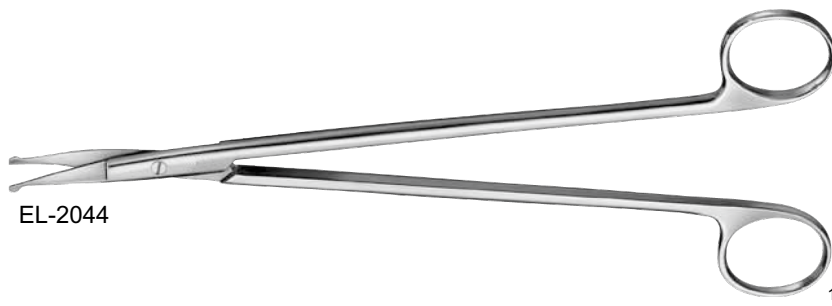

EL-2044

1/1

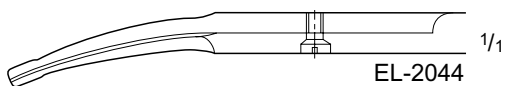

EL-2044

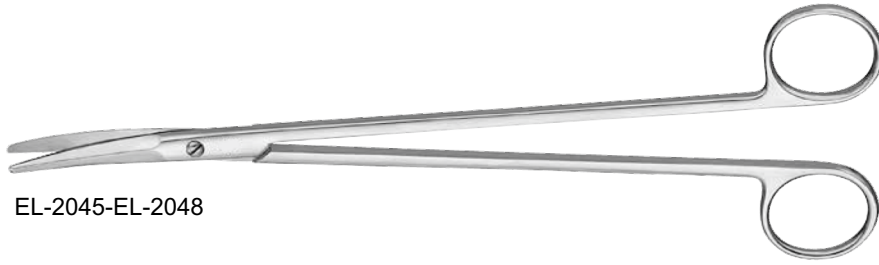

EL-2045-EL-2048

POTTS-SMITH Dissecting Scissors

Catalog Number	Tip	Blade	Length (in.)
EL-2045	B/B	CVD	5 1/2
EL-2046	B/B	CVD	7 1/2
EL-2047	B/B	CVD	9
EL-2048	B/B	CVD	11 1/4

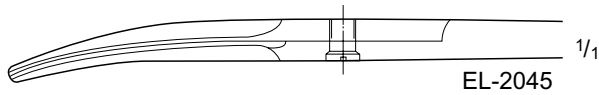

EL-2045



EL-2047

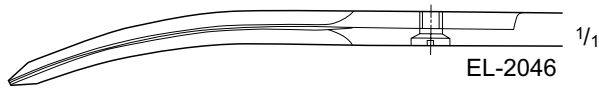

EL-2046



EL-2048

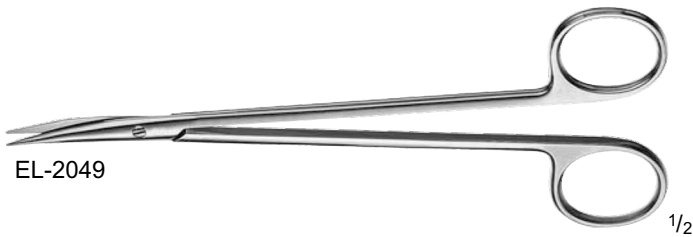

EL-2049

MORSE Scissors

Catalog Number	Tip	Blade	Length (in.)
EL-2049	S/S	CVD	6 7/8



EL-2049

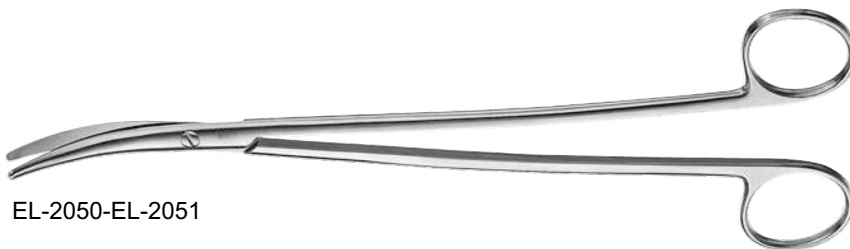

EL-2050-EL-2051

HOHENFELLNER Scissors

Catalog Number	Tip	Blade	Length (in.)
EL-2050	B/B	CVD	8 7/8
EL-2051	B/B	CVD	10

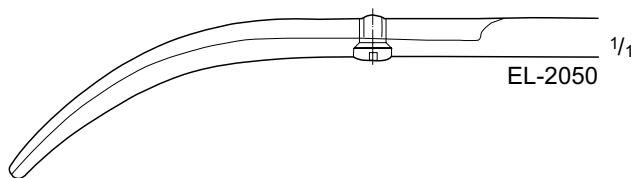

EL-2050

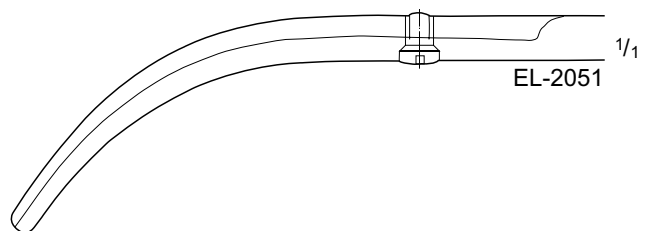

EL-2051

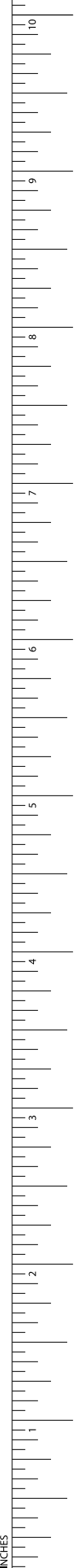

Cardiovascular Scissors

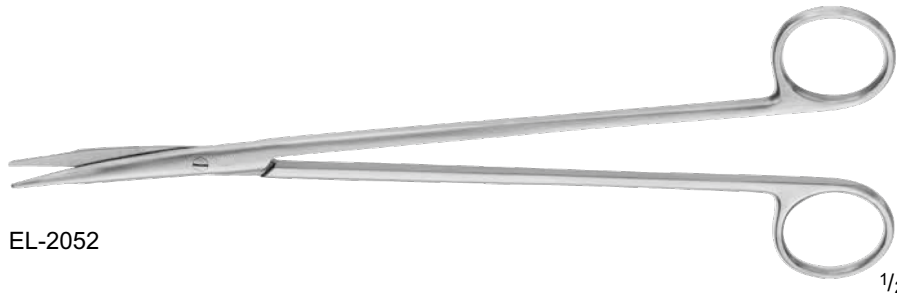
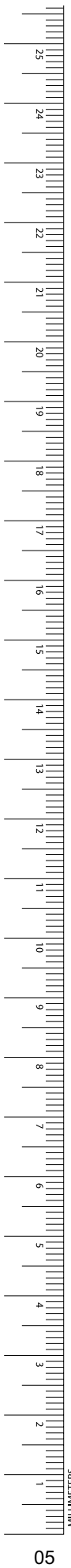

EL-2052

JAMESON-METZENBAUM Scissors

Catalog Number	Tip	Blade	Length (in.)
EL-2052	S/S	CVD	9

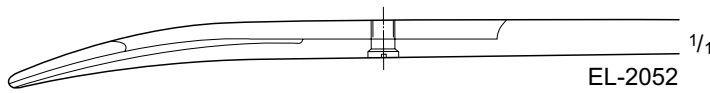

EL-2052



EL-2053

LILLEHEI-POTTS Tenotomy Scissors

Catalog Number	Tip	Blade	Length (in.)
EL-2053	S/S	CVD	7



EL-2053

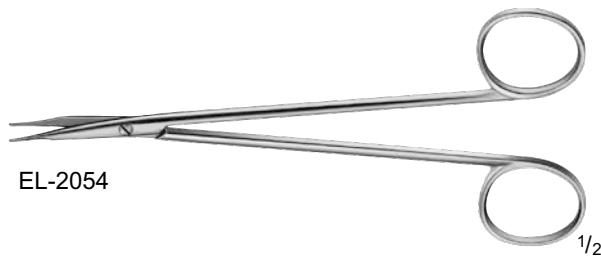

EL-2054

JAMESON Tenotomy Scissors, Delicate

Catalog Number	Tip	Blade	Length (in.)
EL-2054	B/B	CVD	6

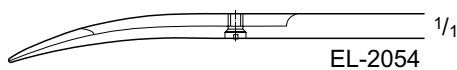

EL-2054

POTTS Tenotomy Scissors

Catalog Number	Tip	Blade	Length (in.)
EL-2055	B/B	CVD	6 7/8
EL-2056	B/B	CVD	8

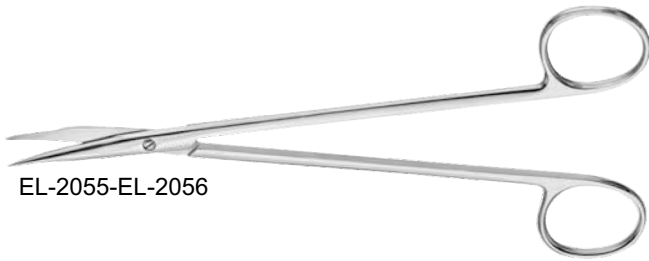

EL-2055-EL-2056



EL-2055



EL-2056

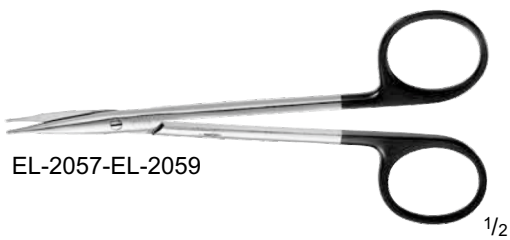

EL-2057-EL-2059

JAMESON SuperCut Scissors, Delicate

Catalog Number	Tip	Blade	Length (in.)
EL-2057	B/B	CVD	5 1/8
EL-2058	B/B	CVD	6
EL-2059	B/B	CVD	7



EL-2057



EL-2058



EL-2059

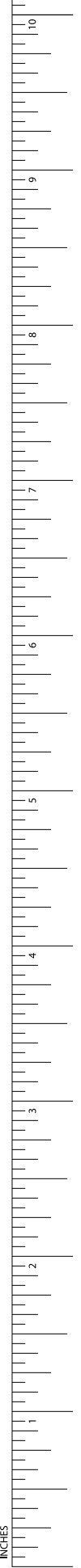

Cardiovascular Delicate Scissors

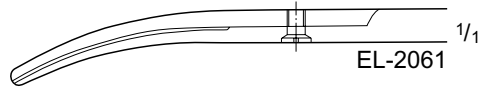
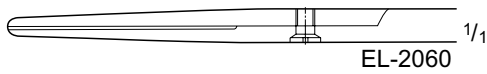
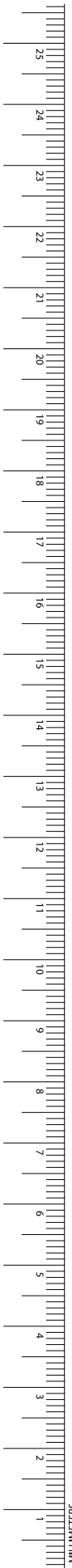

METZENBAUM SuperCut Scissors

Catalog Number	Tip	Blade	Length (in.)
EL-2060	B/B	STR	7
EL-2061	B/B	CVD	7

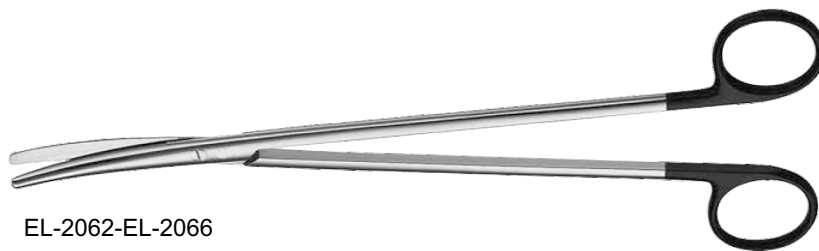

METZENBAUM SuperCut Scissors

Catalog Number	Tip	Blade	Length (in.)
EL-2062	B/B	CVD	9
EL-2063	B/B	CVD	10 1/4
EL-2064	B/B	CVD	11 1/4
EL-2065	B/B	CVD	11 3/4
EL-2066	B/B	CVD	14

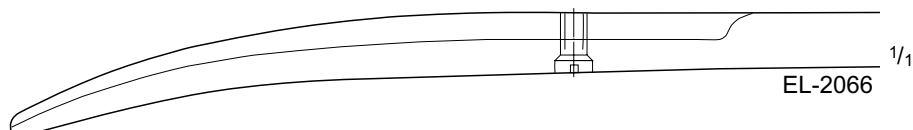
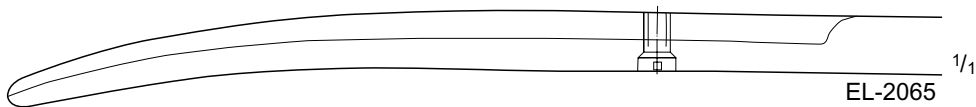
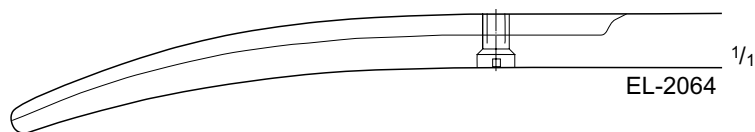



EL-2067-EL-2068

1/2

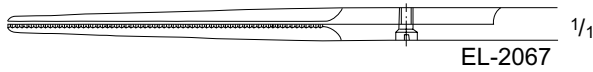

EL-2067

1/1

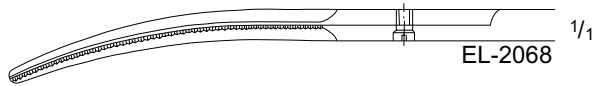

EL-2068

1/1

GORNEY Scissors

Catalog Number	Tip	Blade	Length (in.)
EL-2067	B/B	STR	7 3/4
EL-2068	B/B	SLIGHT-CVD	7 3/4



EL-2069-EL-2070

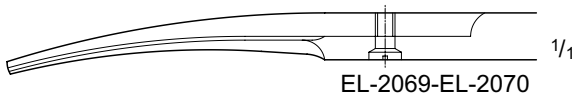

EL-2069-EL-2070

1/1

COOLEY Cardiovascular Scissors

Catalog Number	Tip	Blade	Length (in.)
EL-2069	B/B	CVD	7 1/2
EL-2070	B/B	CVD	9

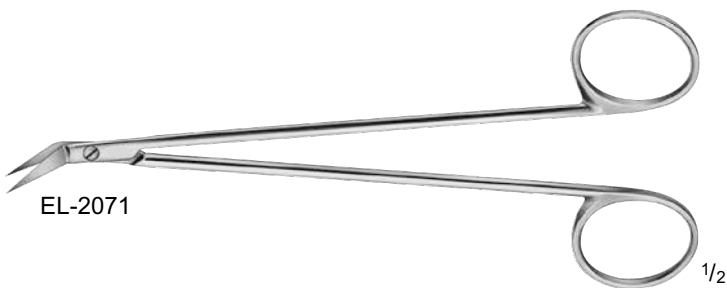

EL-2071

1/2

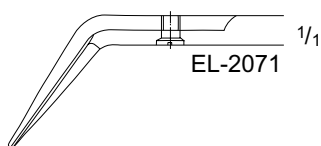

EL-2071

1/1

POTTS-SMITH Lateral Angle Scissors

Catalog Number	Tip	Blade Angle	Blade Length (mm)	Length (in.)
EL-2071	S/S	55°	19	7

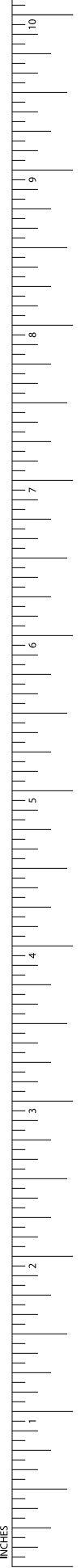

Cardiovascular Delicate Scissors

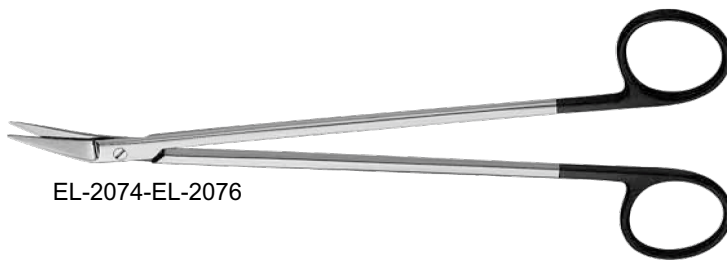
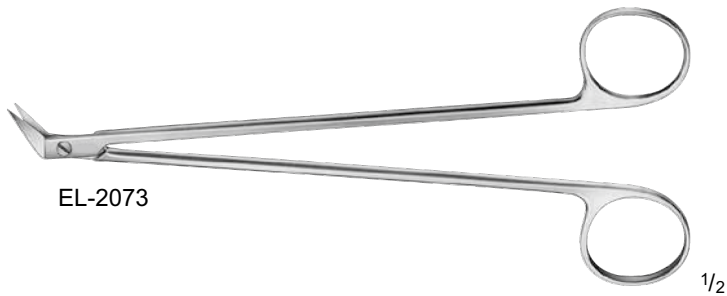
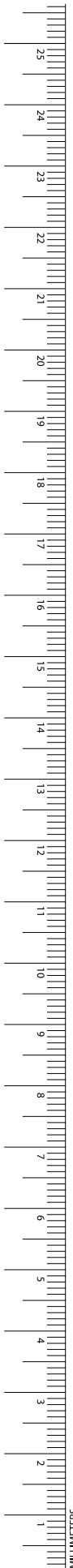

POTTS-SMITH Reverse Scissors

Catalog Number	Tip	Blade Angle	Handle	Length (in.)
EL-2072	S/S	130°	W/ STABILIZING BAR	7

POTTS-SMITH Vessel Scissors

Catalog Number	Tip	Blade Angle	Blade Length (mm)	Length (in.)
EL-2073	S/S	60°	10	6 7/8

POTTS-SMITH SuperCut Scissors

Catalog Number	Tip	Blade Angle	Blade Length (mm)	Length (in.)
EL-2074	B/B	25°	22	7 1/2
EL-2075	B/B	45°	20	7 1/4
EL-2076	B/B	60°	19	7

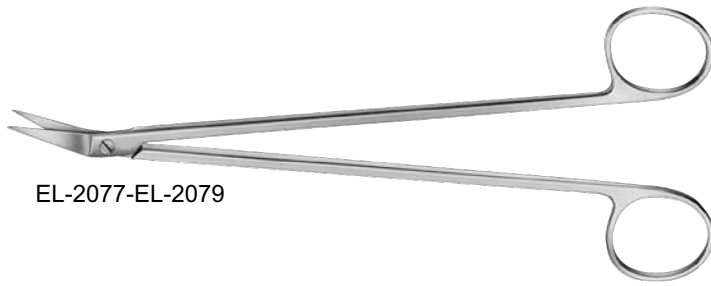

EL-2077-EL-2079



EL-2077



EL-2078



EL-2079

POTTS-DE MARTEL Scissors

Catalog Number	Tip	Blade Angle	Blade Length (mm)	Length (in.)
EL-2077	S/S	30°	21	7 1/4
EL-2078	S/S	45°	21	7 1/4
EL-2079	S/S	60°	21	7 1/4
EL-2080	S/S	60°	21	8 3/4

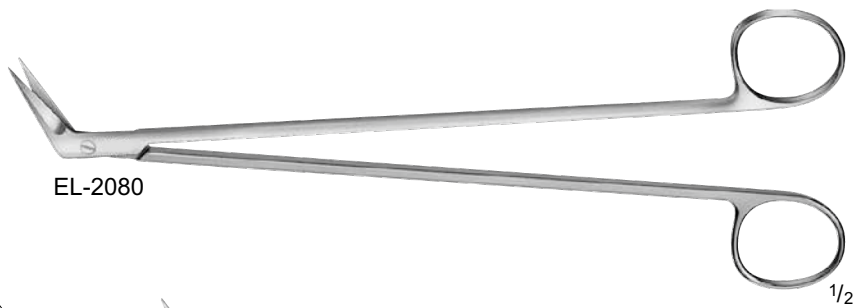

EL-2080

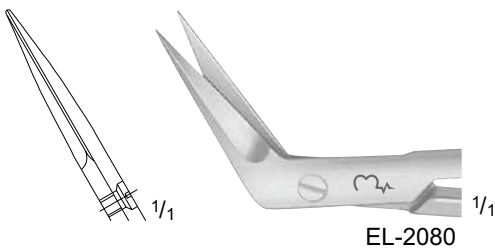

EL-2080

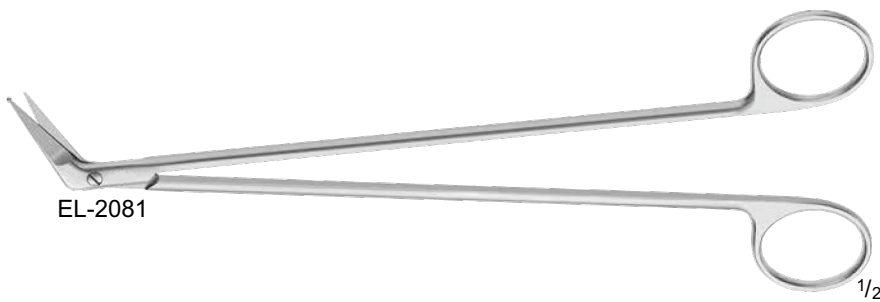

EL-2081

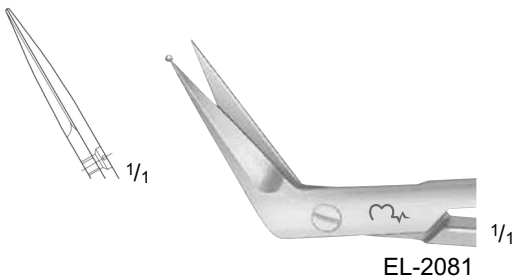

EL-2081

MILLS Scissors

Catalog Number	Tip	Blade	Blade Length (mm)	Length (in.)
EL-2081	1 BALL-POINT	60°	23	8 3/4

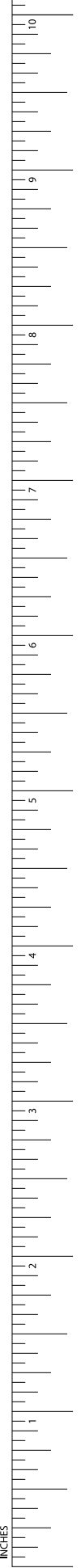

Cardiovascular Delicate Scissors

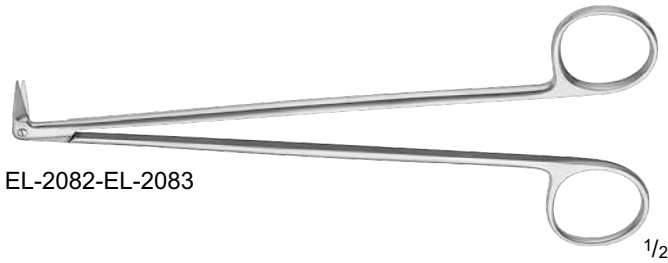
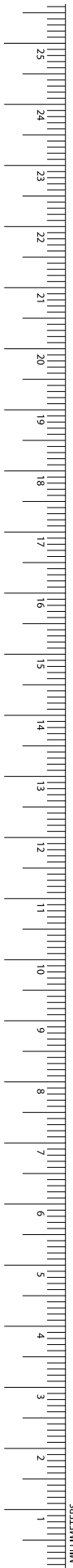

EL-2082-EL-2083

1/2

DIETHRICH Vessel Scissors

Catalog Number	Tip	Blade Angle	Blade Length (mm)	Length (in.)
EL-2082	S/S	90°	12	6 3/4
EL-2083	S/S	120°	10	6 3/4

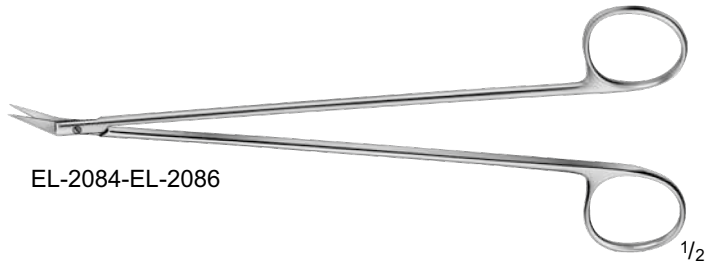

EL-2084-EL-2086

1/2

DIETHRICH-HEGEMANN Vessel Scissors

Catalog Number	Tip	Blade Angle	Blade Length (mm)	Length (in.)
EL-2084	S/S	25°	15	7
EL-2085	S/S	45°	15	7
EL-2086	S/S	60°	15	7

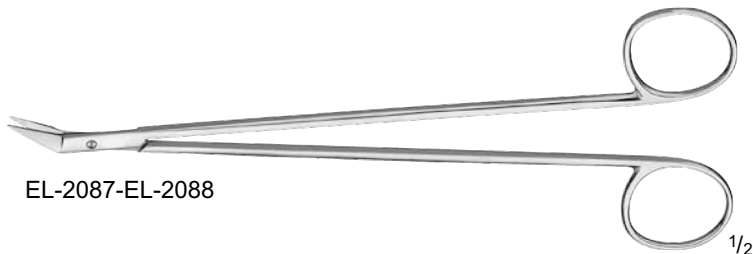

EL-2087-EL-2088

1/2

DIETHRICH Coronary Artery Scissors

Catalog Number	Tip	Blade Angle	Blade Length (mm)	Length (in.)
EL-2087	S/S	25°	13	7 1/4
EL-2088	S/S	45°	14	7 1/4



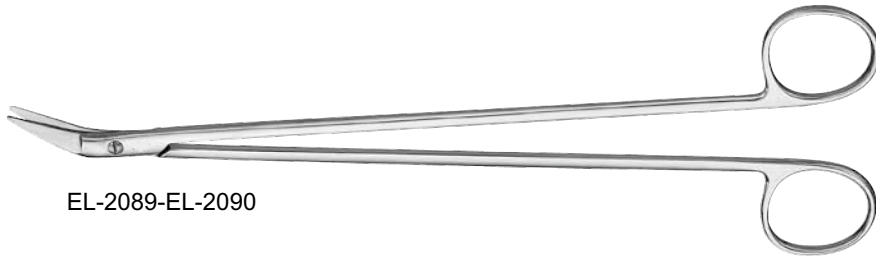

EL-2089-EL-2090

COOLEY Arteriotomy Scissors

Catalog Number	Tip	Blade Angle	Blade Length (mm)	Length (in.)
EL-2089	B/B	30°	21.5	8 7/8
EL-2090	B/B	30°	21.5	10 3/4



EL-2089



EL-2090

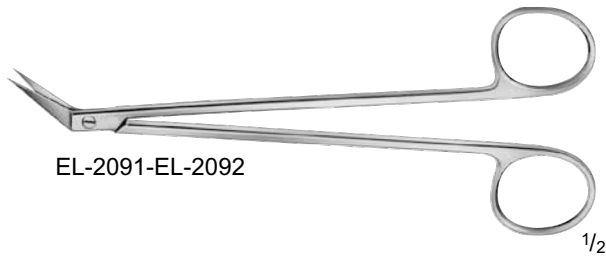

EL-2091-EL-2092

DEBAKEY Vessel Scissors

Catalog Number	Tip	Blade Angle	Blade Length (mm)	Length (in.)
EL-2091	S/S	45°	18	6 1/8
EL-2092	S/S	60°	18	6 1/8

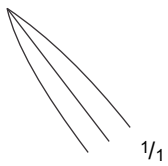

1/1

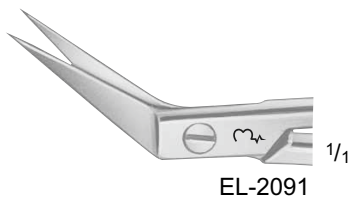

EL-2091



EL-2092



EL-2093

DEBAKEY O...set Scissors, S-Shaped

Catalog Number	Tip	Blade Angle	Blade Length (mm)	Length (in.)
EL-2093	S/S	45°	24	6 1/8

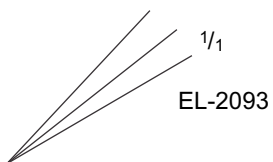

EL-2093

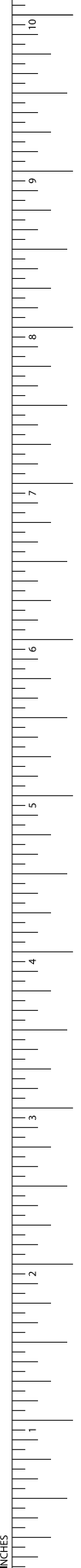

Cardiovascular Delicate Scissors

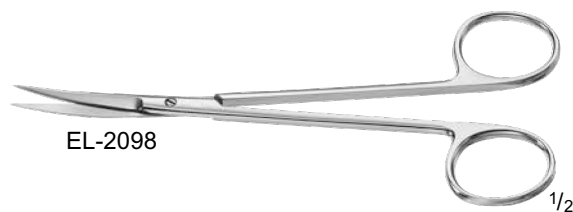
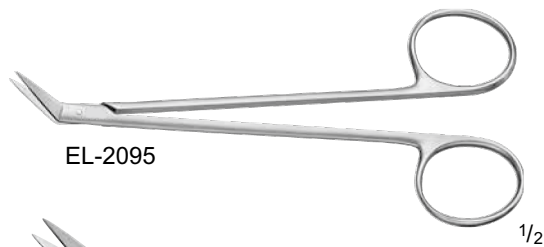
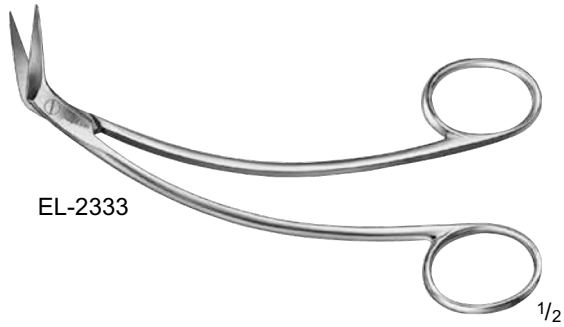
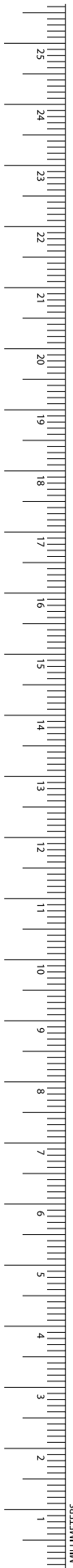

FAVOLORO Artery Scissors

Catalog Number	Tip	Blade Angle	Blade Length (mm)	Length (in.)
EL-2094	S/S	45°	20	5 1/2

POTTS Vascular Scissors

Catalog Number	Tip	Blade Angle	Blade Length (mm)	Length (in.)
EL-2095	S/S	45°	13	5 1/4

Valve Leaflet Excision Scissors

Catalog Number	Tip	Blade Angle	Length (in.)
EL-2096	B/B	45°	5 3/4

POTTS Arteriotomy Scissors

Catalog Number	Tip	Blade Angle	Length (in.)
EL-2097	B/B	60°	5 3/8

COOLEY Neonatal Scissors

Catalog Number	Tip	Blade	Length (in.)
EL-2098	S/S	CVD	5 3/4

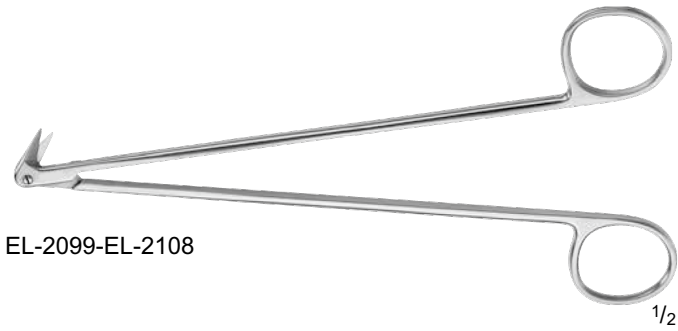

EL-2099-EL-2108

DIETHRICH-POTTS Micro Scissors

Catalog Number	Tip	Blade	Blade Angle	Blade Length (mm)	Length (in.)
EL-2099	S/S	X-DEL	25°	8	7
EL-2100	S/S	X-DEL	45°	8	7
EL-2101	S/S	X-DEL	60°	8	7
EL-2102	S/S	X-DEL	90°	8	7
EL-2103	S/S	X-DEL	125°	8	7
EL-2104	S/S	DEL	25°	10	7
EL-2105	S/S	DEL	45°	10	7
EL-2106	S/S	DEL	60°	10	7
EL-2107	S/S	DEL	90°	10	7
EL-2108	S/S	DEL	125°	10	7
EL-2109	S/S	FINE	25°	12	7
EL-2110	S/S	FINE	45°	12	7
EL-2111	S/S	FINE	60°	12	7
EL-2112	S/S	FINE	90°	12	7
EL-2113	S/S	FINE	125°	12	7

Blade Length: **8 MM**

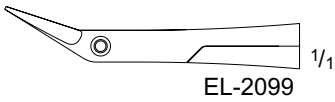

EL-2099

Blade Length: **10 MM**

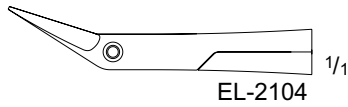

EL-2104

Blade Length: **12 MM**

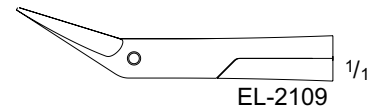

EL-2109

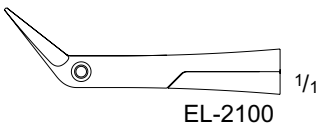

EL-2100

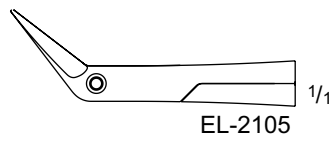

EL-2105

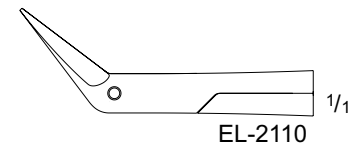

EL-2110

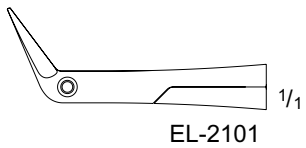

EL-2101

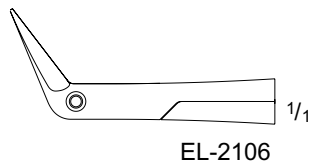

EL-2106

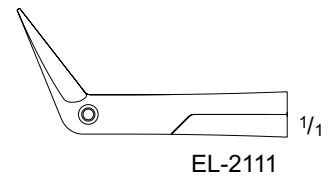

EL-2111

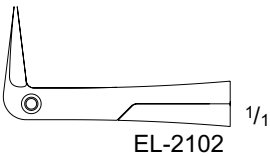

EL-2102

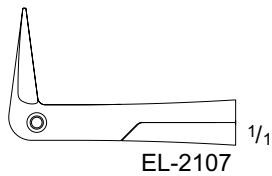

EL-2107

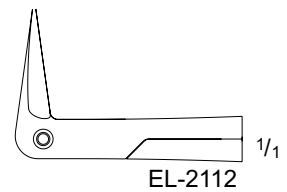

EL-2112

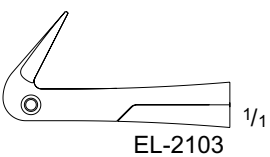

EL-2103

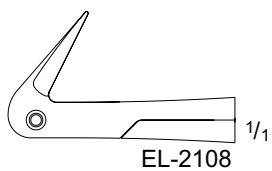

EL-2108

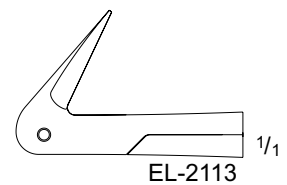

EL-2113

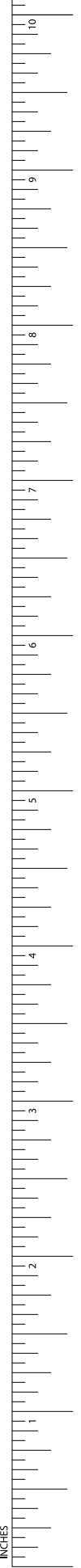

Cardiovascular Scissors

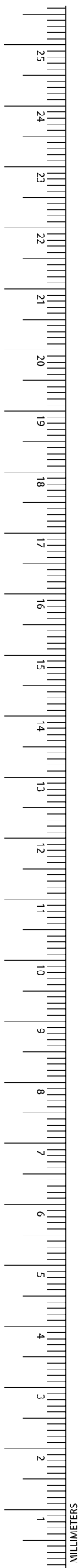

DIETRICH SuperCut Scissors

Catalog Number	Tip	Blade	Length (in.)
EL-2114	S/S	25°	7
EL-2115	S/S	45°	7
EL-2116	S/S	60°	7
EL-2117	S/S	90°	7
EL-2118	S/S	125 °	7

- Excellent cutting accuracy
- Long working life
- Gold-plated rings

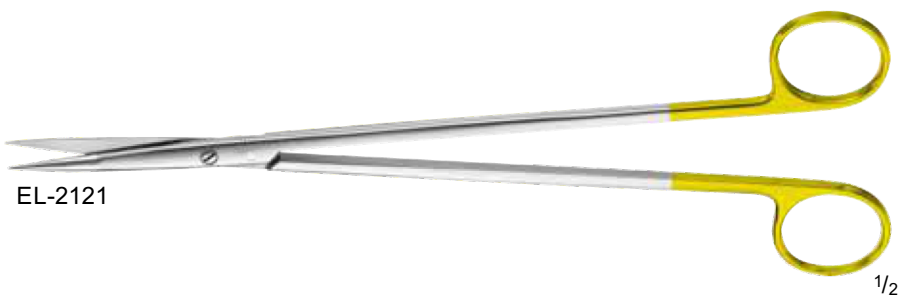
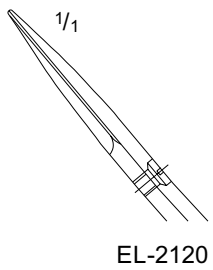
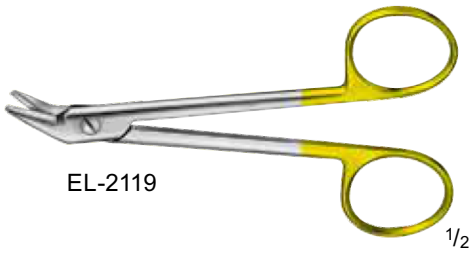

TC Wire Cutting Scissors

Catalog Number	Blade	For Wire Size	Length (in.)
EL-2119	1-SERR	SOFT, UP TO 1.2 MM AND HARD, UP TO 0.8 MM	4 3/4

TC DEBAKEYVascular Scissors

Catalog Number	Tip	Blade Angle	Blade Length (mm)	Length (in.)
EL-2120	S/S	60°	21	8 3/4

TC DEMARTELVascular Scissors

Catalog Number	Tip	Blade	Length (in.)
EL-2121	S/S	CVD	6 3/4



Cardiovascular TC Tungsten Carbide Scissors

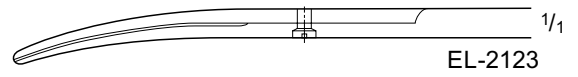
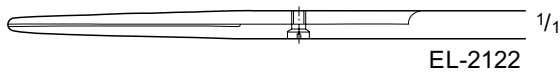
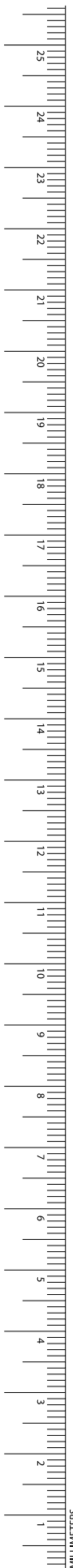

TC Baby METZENBAUM Dissecting Scissors, Delicate

Catalog Number	Tip	Blade	Length (in.)
EL-2122	B/B	STR	5 3/4
EL-2123	B/B	CVD	5 3/4

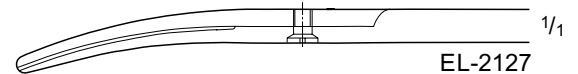
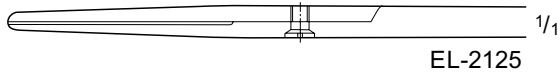
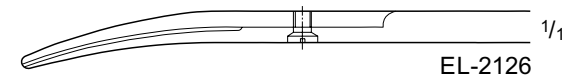
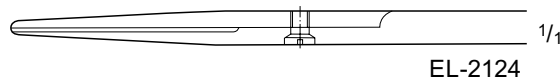
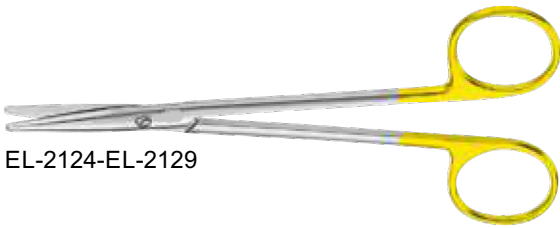

TC METZENBAUM Dissecting Scissors

Catalog Number	Tip	Blade	Length (in.)
EL-2124	B/B	STR	5 3/4
EL-2125	B/B	STR	7
EL-2126	B/B	CVD	5 3/4
EL-2127	B/B	CVD	7
EL-2128	B/B	CVD	7 7/8
EL-2129	B/B	CVD	9

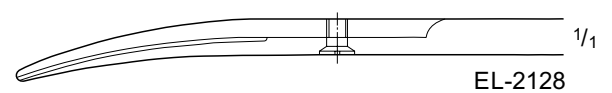
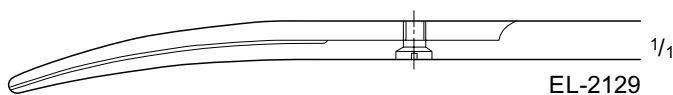

Cardiovascular TC Tungsten Carbide Scissors

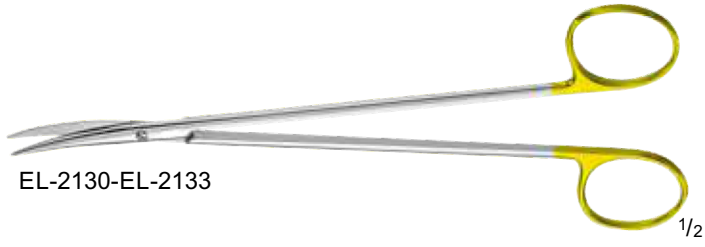

TC METZENBAUM Dissecting Scissors, Delicate

Catalog Number	Tip	Blade	Length (in.)
EL-2130	S/S	STR	9 1/4
EL-2131	S/S	CVD	5 3/4
EL-2132	S/S	CVD	7
EL-2133	S/S	CVD	9 1/4

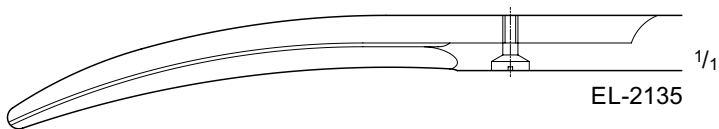
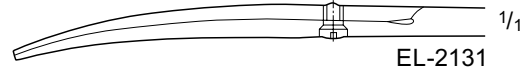

TC MAYO Dissecting Scissors

Catalog Number	Tip	Blade	Length (in.)
EL-2134	B/B	STR	9
EL-2135	B/B	CVD	9

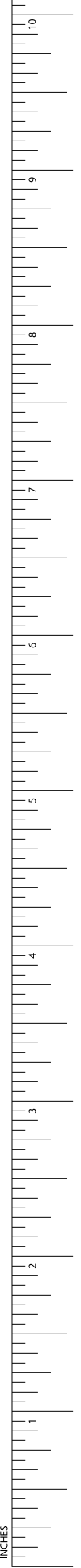

Cardiovascular TC Tungsten Carbide Scissors

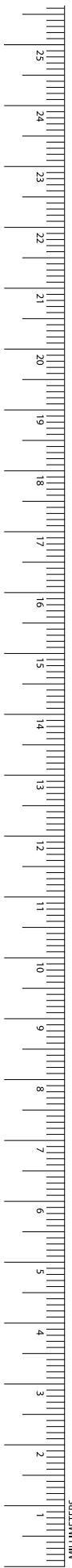

Wavecut

Wavecut scissors have one serrated cutting edge to prevent tissue from slipping. The **W** after the item number indicates the scissors are the wavecut style, e.g.



EL-2136

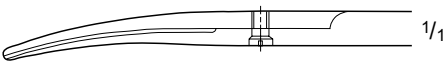

EL-2136



EL-2137

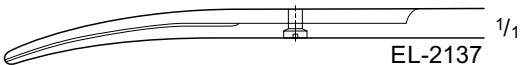

EL-2137

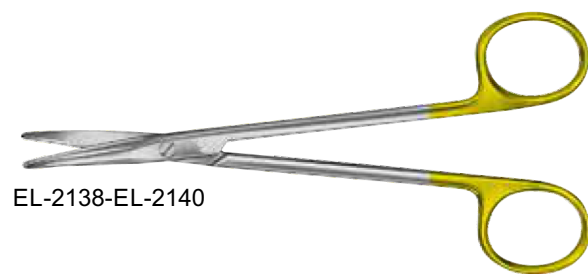

EL-2138-EL-2140

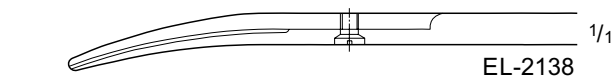

EL-2138

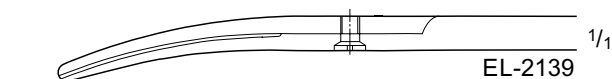

EL-2139

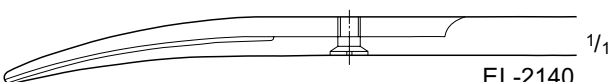

EL-2140

TC TOENNIS-ADSON Wavecut Dissecting Scissors

Catalog Number	Tip	Blade	Length (in.)
EL-2136	B/B	CVD	6 7/8

TC Baby METZENBAUM Wavecut Dissecting Scissors, Delicate

Catalog Number	Tip	Blade	Length (in.)
EL-2137	B/B	CVD	5 3/4

TC METZENBAUM Wavecut Dissecting Scissors

Catalog Number	Tip	Blade	Length (in.)
EL-2138	B/B	CVD	5 3/4
EL-2139	B/B	CVD	7
EL-2140	B/B	CVD	7 7/8

Cardiovascular TC Tungsten Carbide Scissors

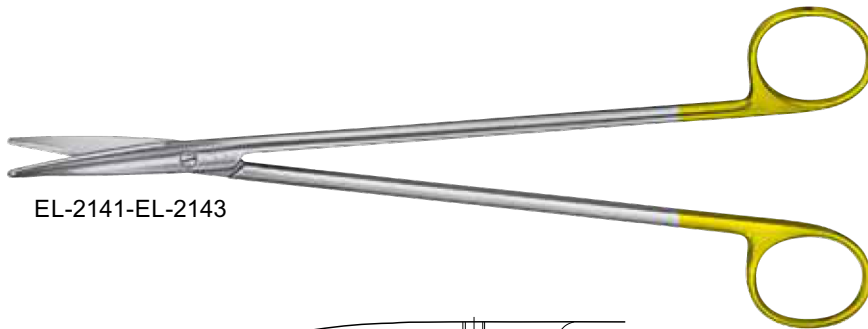

EL-2141-EL-2143

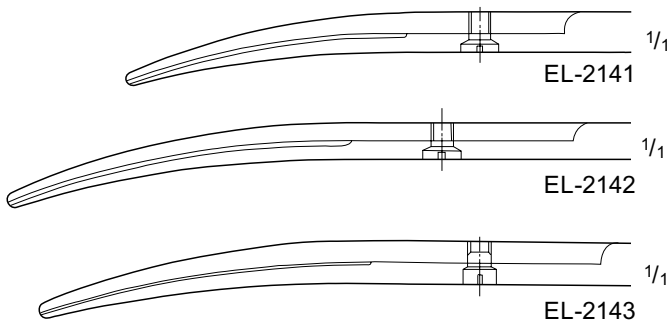

TC NELSON-METZENBAUM Wavecut Dissecting Scissors

Catalog Number	Tip	Blade	Length (in.)
EL-2141	B/B	CVD	9
EL-2142	B/B	CVD	10 1/4
EL-2143	B/B	CVD	11

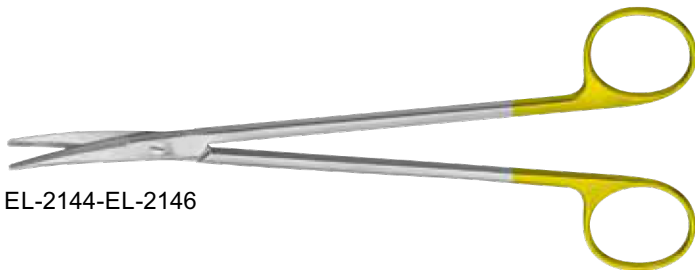

EL-2144-EL-2146

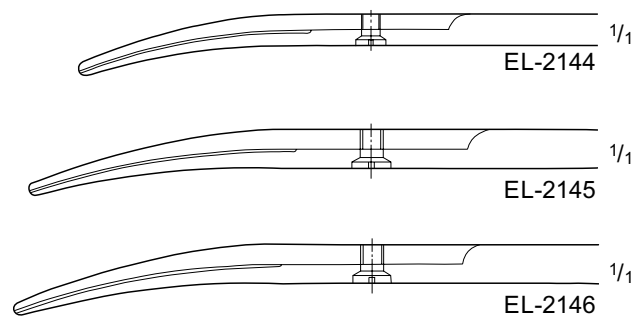

TC METZENBAUM Wavecut Dissecting Scissors, Delicate

Catalog Number	Tip	Blade	Length (in.)
EL-2144	B/B	CVD	7
EL-2145	B/B	CVD	7 7/8
EL-2146	B/B	CVD	9



EL-2147

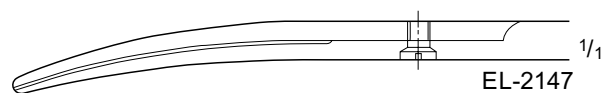

TC METZENBAUM Wavecut Dissecting Scissors, Heavy

Catalog Number	Tip	Blade	Length (in.)
EL-2147	B/B	CVD	9



Cardiovascular

TC Tungsten Carbide Scissors

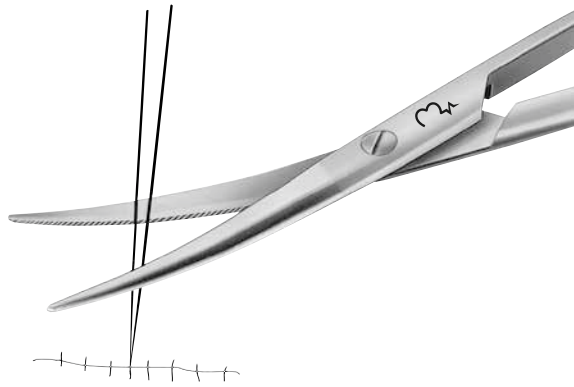
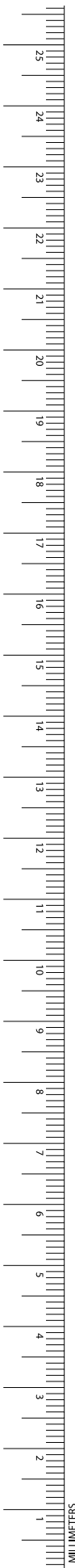

TC Ligature Scissors

- Carbide inserts help ensure sharp cutting edge (also in the distal area of the blades).
- Wavecut helps prevent suture materials from slipping.
- Identified by 1 gold-plated ring.



EL-2148-EL-2152

TC Ligature Wavecut Scissors

Catalog Number	Tip	Blade	Length (in.)
EL-2148	B/B	CVD	5 3/4
EL-2149	B/B	CVD	7
EL-2150	B/B	CVD	9
EL-2151	B/B	CVD	10 1/4
EL-2152	B/B	CVD	13 3/4

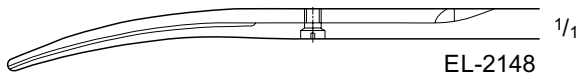

EL-2148

1/1

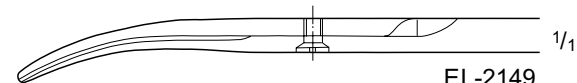

EL-2149

1/1

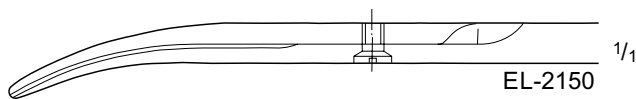

EL-2150

1/1

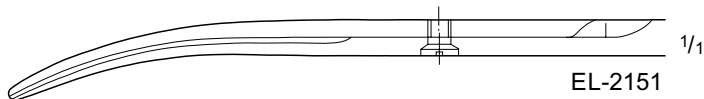

EL-2151

1/1

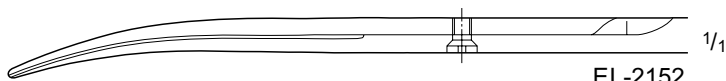

EL-2152

1/1

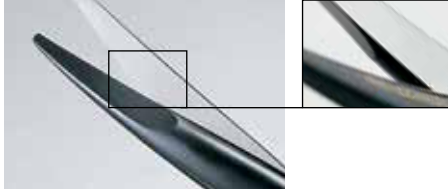

Microtome Edge

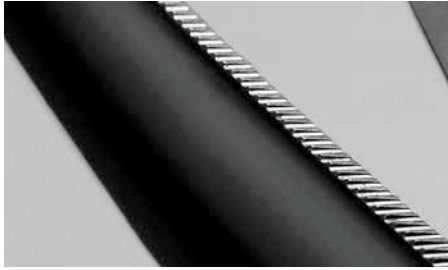

Wavecut

Supreme Cut Scissors

The combination of the renowned Elite Tungsten Carbide technology with the Elite Noir coating results in an extremely high surface hardness and therefore high wear resistance in daily hospital use.

- Microtome edge
The extremely sharp cutting edge of the scissors blade facilitates gentle cutting of tissue with minimal use of force.
- Wavecut helps prevent tissue from slipping out during the cutting process.
- The **WB** after the item number indicates the scissors are the wavecut style, e.g.



EL-2153-EL-2156



EL-2153



EL-2154-EL-2155



EL-2156-EL-2157



EL-2156-EL-2157

MAYO Dissecting Scissors

Catalog Number	Tip	Blade	Length (in.)
EL-2153	B/B	STR	6 3/4
EL-2154	B/B	CVD	6 3/4
EL-2155	B/B	CVD	6 3/4

MAYO-LEXER Dissecting Scissors

Catalog Number	Tip	Blade	Length (in.)
EL-2156	B/B	CVD	6 1/2
EL-2157	B/B	CVD	6 1/2

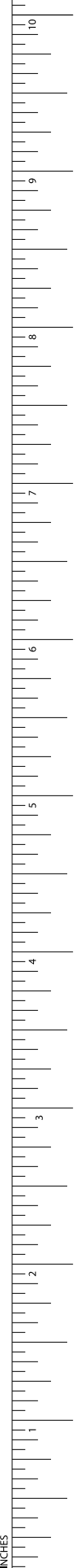

Cardiovascular Supreme Cut Scissors



LEXER Dissecting Scissors

Catalog Number	Tip	Blade	Length (in.)
EL-2158	B/B	DEL, CVD	6 1/2
EL-2159	B/B	DEL, CVD	6 1/2

Iris Dissecting Scissors

Catalog Number	Tip	Blade	Length (in.)
EL-2160	S/S	STR	4 1/4
EL-2161	S/S	CVD	4 1/4
EL-2162	S/S	CVD	4 1/4

TOENNIS-ADSON Dissecting Scissors

Catalog Number	Tip	Blade	Length (in.)
EL-2163	B/B	DEL, CVD	6 7/8
EL-2164	B/B	DEL, CVD	6 7/8

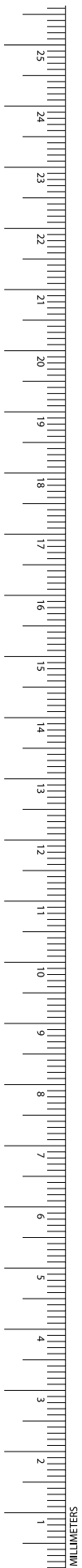

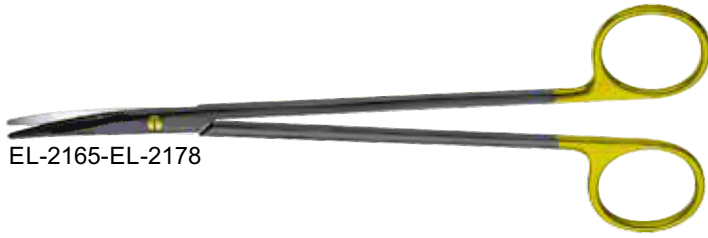

EL-2165-EL-2178



EL-2165-EL-2166



EL-2167-EL-2168



EL-2169-EL-2170

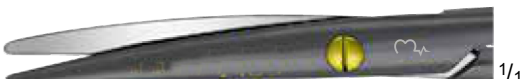

EL-2171-EL-2172



EL-2173-EL-2174

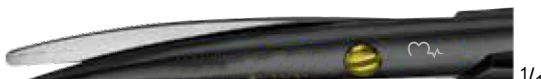

EL-2175-EL-2176



EL-2177-EL-2178

METZENBAUM Dissecting Scissors

Catalog Number	Tip	Blade	Length (in.)
EL-2165	B/B	CVD	5 3/4
EL-2166	B/B	CVD	5 3/4
EL-2167	B/B	CVD	7
EL-2168	B/B	CVD	7
EL-2169	B/B	DEL, CVD	7
EL-2170	B/B	DEL, CVD	7
EL-2171	B/B	CVD	7 7/8
EL-2172	B/B	CVD	7 7/8
EL-2173	B/B	DEL, CVD	7 7/8
EL-2174	B/B	DEL, CVD	7 7/8
EL-2175	B/B	CVD	9
EL-2176	B/B	CVD	9
EL-2177	B/B	DEL, CVD	9
EL-2178	B/B	DEL, CVD	9

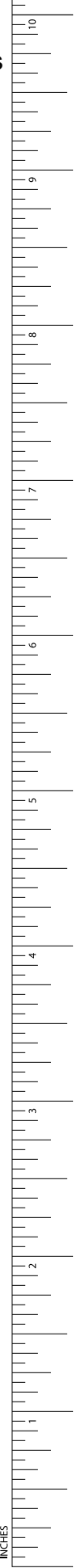

Cardiovascular
Supreme Cut Scissors

NELSON-METZENBAUM
Dissecting Scissors

Catalog Number	Tip	Blade	Length (in.)
EL-2179	B/B	DEL, CVD	10 1/4
EL-2180	B/B	DEL, CVD	10 1/4
EL-2181	B/B	DEL, CVD	11
EL-2182	B/B	DEL, CVD	11

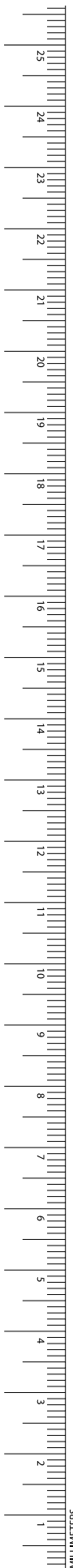

EL-2179-EL-2182



EL-2179-EL-2180

1/1



EL-2181-EL-2182

1/1

Cardiovascular Micro Scissors



EL-2183-EL-2184

1/2



EL-2183

1/1



EL-2184

1/1



EL-2185

1/2



1/1

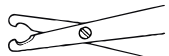

EL-2185



EL-2188-EL-2189

1/2



EL-2188

1/1

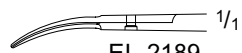

EL-2189

1/1

MILLESI Micro Scissors

Catalog Number	Tip	Blade	Handle	Length (in.)
EL-2183	S/S	STR, SERR	FLAT SERR	6
EL-2184	S/S	CVD, SERR	FLAT SERR	6

BIEMER Vein Scissors

Catalog Number	Blade	Handle	Length (in.)
EL-2185	STR	FLAT SERR	5 1/8

YASARGIL Micro Vessel Scissors

Catalog Number	Blade	Handle	Length (in.)
EL-2188	STR	FLAT SERR	7 1/4
EL-2189	CVD	FLAT SERR	7 1/4



INCHES

Cardiovascular

Micro Scissors

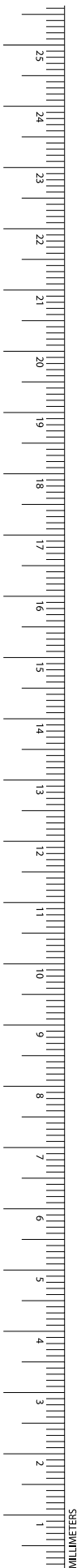

Blade: **STR**

Blade: **25°**

Blade: **45°**



Blade: **CVD**



Blade: **60°**

Blade: **90°**

Blade: **125°**

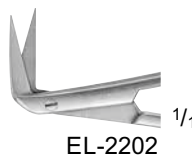

Micro Scissors, Flat Handle

Catalog Number	Tip	Blade	Blade Angle	Blade Length (mm)	Length (in.)
EL-2190	S/S	X-DEL	STR	7	6 1/2
EL-2191	S/S	X-DEL	CVD	7	6 1/2
EL-2192	S/S	X-DEL	25°	7	6 1/2
EL-2193	S/S	X-DEL	45°	7	6 1/2
EL-2194	S/S	X-DEL	60°	7	6 1/2
EL-2195	S/S	X-DEL	90°	7	6 1/2
EL-2196	S/S	X-DEL	125°	7	6 1/2
EL-2197	S/S	DEL	STR	10	6 1/2
EL-2198	S/S	DEL	CVD	10	6 1/2
EL-2199	S/S	DEL	25°	10	6 1/2
EL-2200	S/S	DEL	45°	10	6 1/2
EL-2201	S/S	DEL	60°	10	6 1/2
EL-2202	S/S	DEL	90°	10	6 1/2
EL-2203	S/S	DEL	125°	10	6 1/2
EL-2204	S/1 BALL-PT	FINE	25°	15	6 1/2
EL-2205	S/1 BALL-PT	FINE	45°	15	6 1/2
EL-2206	S/1 BALL-PT	FINE	60°	15	6 1/2
EL-2207	S/1 BALL-PT	FINE	90°	15	6 1/2
EL-2208	S/1 BALL-PT	FINE	125°	15	6 1/2
EL-2209	S/S	FINE	25°	15	6 1/2
EL-2210	S/S	FINE	45°	15	6 1/2
EL-2211	S/S	FINE	60°	15	6 1/2
EL-2212	S/S	FINE	90°	15	6 1/2
EL-2213	S/S	FINE	125°	15	6 1/2

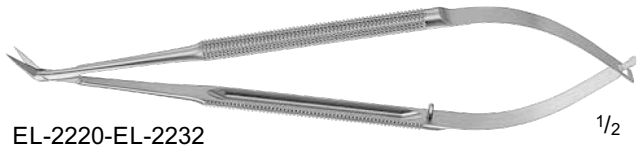

EL-2220-EL-2232

1/2

Blade: STR



EL-2220

Blade: 25°



EL-2215

Blade: 45°



EL-2216

Blade: CVD



EL-2214



EL-2222



EL-2223



EL-2221



EL-2227



EL-2228



EL-2232



EL-2233

Blade: 60°



EL-2217

Blade: 90°



EL-2218

Blade: 125°



EL-2219



EL-2224



EL-2225



EL-2226



EL-2229



EL-2230



EL-2231



EL-2234



EL-2235



EL-2236

Micro Scissors, Round Handle

Catalog Number	Tip	Blade	Blade Angle	Blade Length (mm)	Length (in.)
EL-2214	S/S	X-DEL	CVD	7	6 1/2
EL-2215	S/S	X-DEL	25°	7	6 1/2
EL-2216	S/S	X-DEL	45°	7	6 1/2
EL-2217	S/S	X-DEL	60°	7	6 1/2
EL-2218	S/S	X-DEL	90°	7	6 1/2
EL-2219	S/S	X-DEL	125°	7	6 1/2
EL-2220	S/S	X-DEL	STR	7	6 1/2
EL-2221	S/S	DEL	CVD	10	6 1/2
EL-2222	S/S	DEL	25°	10	6 1/2
EL-2223	S/S	DEL	45°	10	6 1/2
EL-2224	S/S	DEL	60°	10	6 1/2
EL-2225	S/S	DEL	90°	10	6 1/2
EL-2226	S/S	DEL	125°	10	6 1/2
EL-2227	S/1 BALL-PT	DEL	25°	10	6 1/2
EL-2228	S/1 BALL-PT	DEL	45°	10	6 1/2
EL-2229	S/1 BALL-PT	DEL	60°	10	6 1/2
EL-2230	S/1 BALL-PT	DEL	90°	10	6 1/2
EL-2231	S/1 BALL-PT	DEL	125°	10	6 1/2
EL-2232	S/S	FINE	25°	15	6 1/2
EL-2233	S/S	FINE	45°	15	6 1/2
EL-2234	S/S	FINE	60°	15	6 1/2
EL-2235	S/S	FINE	90°	15	6 1/2
EL-2236	S/S	FINE	125°	15	6 1/2

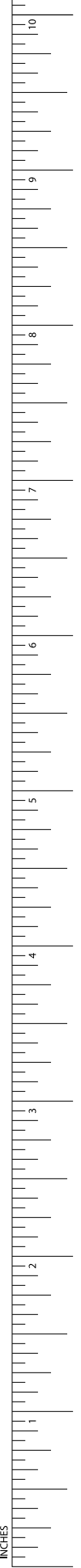

Cardiovascular

Special CV Scissors

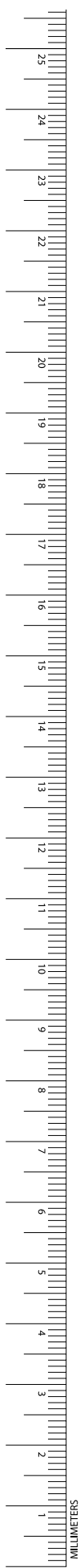

EL-2237-EL-2238



EL-2237

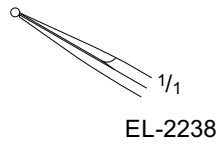

EL-2238



EL-2239



EL-2239



EL-2240-EL-2242

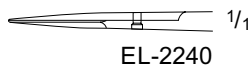

EL-2240

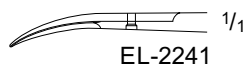

EL-2241

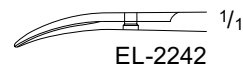

EL-2242



EL-2243-EL-2246

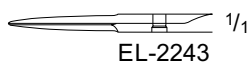

EL-2243

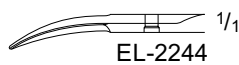

EL-2244

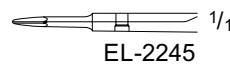

EL-2245

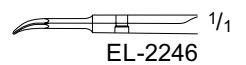

EL-2246

NAGEL Micro Scissors

Catalog Number	Tip	Blade	Length (in.)
EL-2237	S/S	45°	7 7/8
EL-2238	PROBE	45°	7 7/8

DEBAKEY Circumflex Micro Scissors

Catalog Number	Tip	Blade	Length (in.)
EL-2239	S/S	125°	7 1/2

Micro Scissors

Catalog Number	Tip	Blade	Handle	Length (in.)
EL-2240	S/S	STR	ROUND	5 3/4
EL-2241	S/S	CVD	ROUND	5 3/4
EL-2242	B/B	CVD	ROUND	5 3/4

Micro Vessel Scissors

Catalog Number	Tip	Blade	Length (in.)
EL-2243	S/S	STR	7 1/2
EL-2244	S/S	CVD	7 1/2
EL-2245	S/S	DEL, STR	7 1/2
EL-2246	S/S	DEL, CVD	7 1/2



EL-2247-EL-2248

1/2

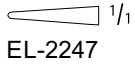

EL-2247



EL-2248

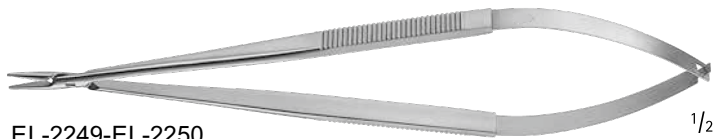

EL-2249-EL-2250

1/2



EL-2249



EL-2250



EL-2251

1/2



EL-2251



EL-2252-EL-2253

1/2



EL-2252



EL-2253



EL-2254-EL-2255

1/2



EL-2254



EL-2255

CASTROVIEJO Micro Needle Holder, W/ Catch

Catalog Number	Tip	Jaw	Length(in.)
EL-2247	STR	SMOOTH	5 3/4
EL-2248	CVD	SMOOTH	5 3/4

JACOBSON Micro Needle Holder

Catalog Number	Tip	Jaw	Length(in.)
EL-2249	W/O CATCH	SMOOTH	7 1/4
EL-2250	W/ CATCH	SMOOTH	7 1/4

Micro Needle Holder, W/ Catch

Catalog Number	Jaw	Length(in.)
EL-2251	SMOOTH	7 1/4

Micro Needle Holder, W/O Catch

Catalog Number	Tip	Jaw	Length(in.)
EL-2252	STR	SMOOTH	6 1/4
EL-2253	CVD	SMOOTH	6 1/4

Micro Needle Holder, W/O Catch

Catalog Number	Tip	Jaw	Length(in.)
EL-2254	STR	SMOOTH	7 1/4
EL-2255	CVD	SMOOTH	7 1/4

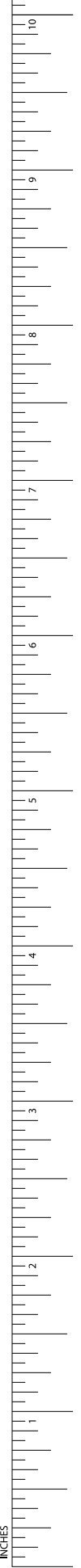

Cardiovascular Micro Needle Holders

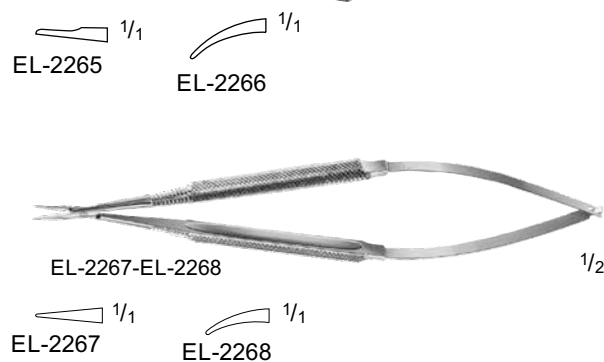
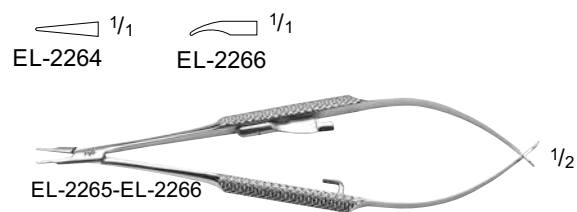
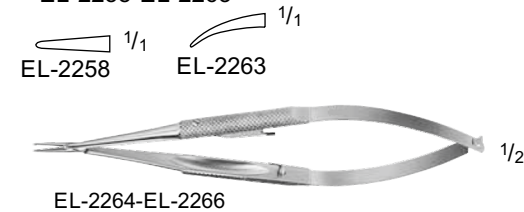
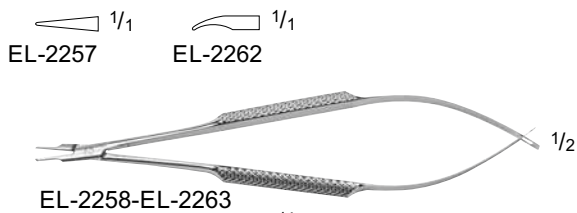
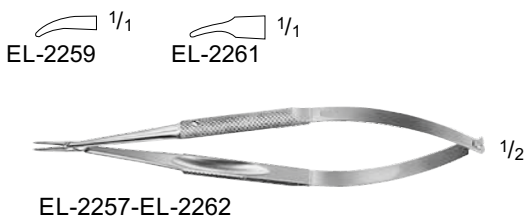
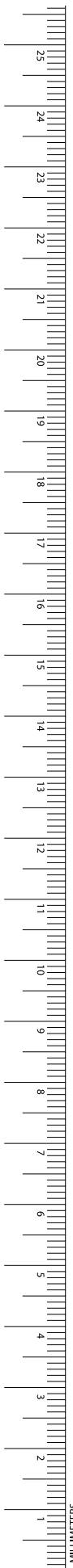

Micro Needle Holder, Bayonet-Shaped

Catalog Number	Tip	Length (in.)
EL-2256	CVD-UP	7 3/4

BARRAQUER Micro Needle Holder, Round Knurled Handle

Catalog Number	Tip	Handle	Length (in.)
EL-2257	STR	W/O CATCH	4 3/4
EL-2258	STR	W/O CATCH	5 1/4
EL-2259	CVD, DEL	W/O CATCH	4 3/4
EL-2260	CVD	W/O CATCH	4 1/4
EL-2261	CVD	W/O CATCH	4 1/2
EL-2262	CVD	W/O CATCH	4 3/4
EL-2263	CVD	W/O CATCH	5 1/4
EL-2264	STR	W/O CATCH	4 3/4
EL-2265	STR	W/O CATCH	5 1/4
EL-2266	CVD	W/O CATCH	4 3/4
EL-2267	CVD	W/O CATCH	5 1/4

REILL Micro Needle Holder, W/O Catch

Catalog Number	Tip	Jaw	Length (in.)
EL-2267	STR	SMOOTH	6
EL-2268	CVD	SMOOTH	6

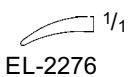
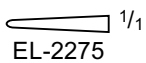
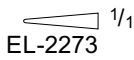
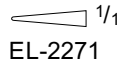
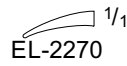
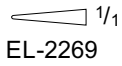

Micro Needle Holder, Round Knurled Handle W/ Catch

Catalog Number	Tip	Jaw	Length (in.)
EL-2269	STR	SMOOTH	6
EL-2270	CVD	SMOOTH	6

Micro Needle Holder, Round Knurled Handle W/O Catch

Catalog Number	Tip	Jaw	Length (in.)
EL-2271	STR	SMOOTH	7 1/4
EL-2272	CVD	SMOOTH	7 1/4

Micro Needle Holder, Round Knurled Handle W/ Catch

Catalog Number	Tip	Jaw	Length (in.)
EL-2273	STR	SMOOTH	7 1/4
EL-2274	CVD	SMOOTH	7 1/4

Round Knurled Handle Micro Needle Holder, W/ Catch

Catalog Number	Tip	Jaw	Length (in.)
EL-2275	STR	SMOOTH	9

MUELLER Micro Needle Holder, Plastic Handle W/ Catch

Catalog Number	Tip	Length (in)
EL-2276	CVD	5 3/4

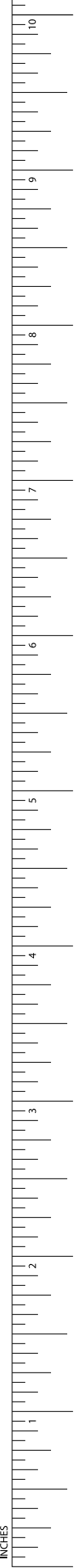

Cardiovascular

TC Micro Needle Holders

Elite features Needle Holders with Tungsten Carbide (TC) inserts. A smooth jaw and three different serration patterns are available, depending on the size of the suture needle.

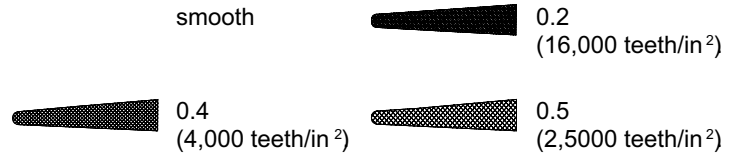

We recommend carbide inserts as follows:

Jaw Surface	Suture Material
Smooth	9/0 - 11/0
0.2 mm pitch of serration	6/0 - 10/0
0.4 mm pitch of serration	4/0 - 6/0
0.5 mm pitch of serration	up to 3/0

TC CASTROVIEJO Micro Needle Holder, Flat Handle

Catalog Number	Jaw	Length (in.)
EL-2277	SMOOTH	5 3/4
EL-2278	SERR	5 3/4
EL-2279	SERR	7
EL-2280	SERR	8 1/2

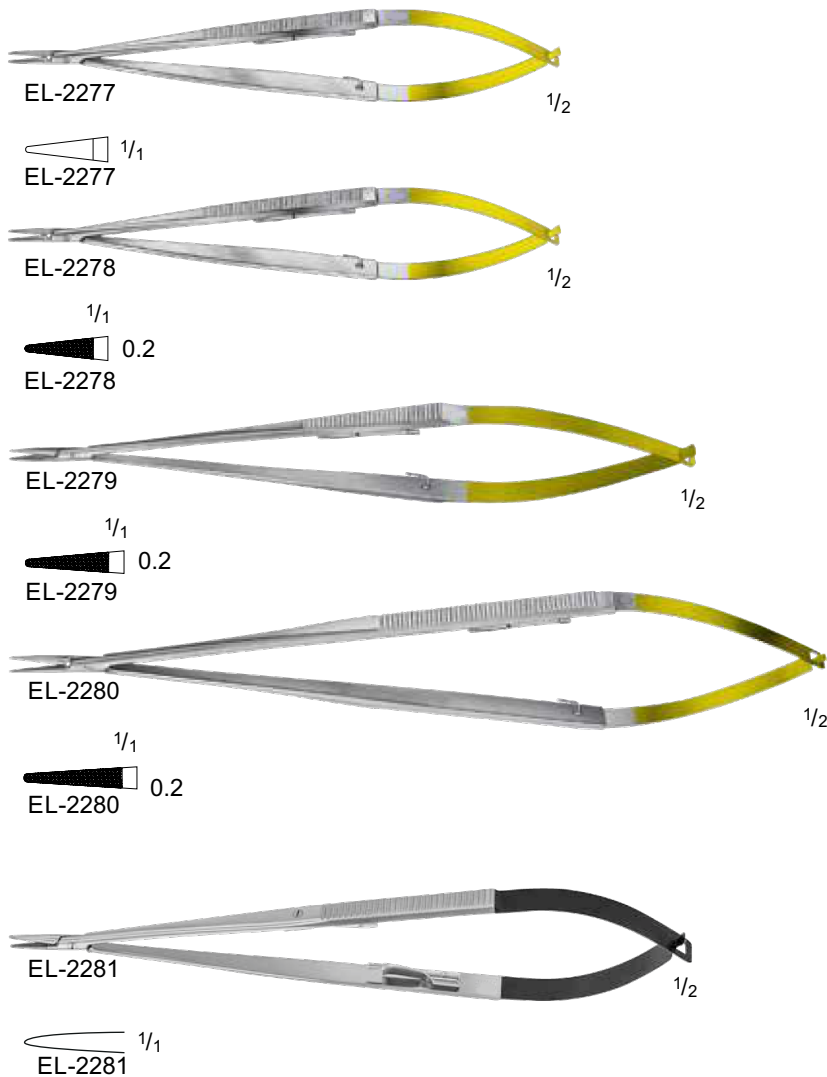

TC SPENCER Coronary Needle Holder

Catalog Number	Jaw	Length (in.)
EL-2281	SMOOTH	7

Cardiovascular TC Micro Needle Holders

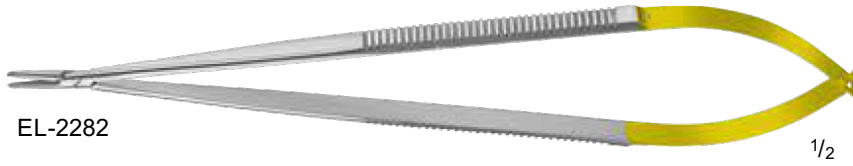

TC JACOBSON Needle Holder, Flat Handle W/O Catch

Catalog Number	Jaw	Length (in.)
EL-2282	SERR	8 3/4

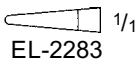
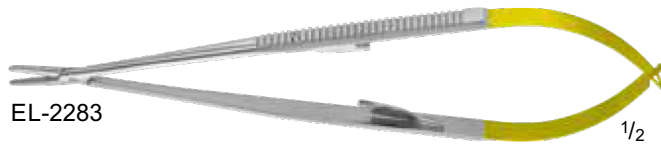

TC Micro Needle Holder, Flat Handle W/ Catch

Catalog Number	Jaw	Length (in.)
EL-2283	SMOOTH	7 1/4

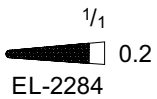

TC MILLS Vascular Needle Holder, Round Handle W/ Catch

Catalog Number	Jaw	Length (in.)
EL-2284	SERR	8

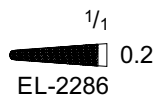
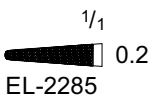

TC Micro Needle Holder, Round Handle W/ Catch

Catalog Number	Jaw	Length (in.)
EL-2285	SERR	7
EL-2286	SERR	7 7/8

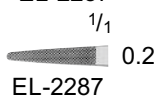
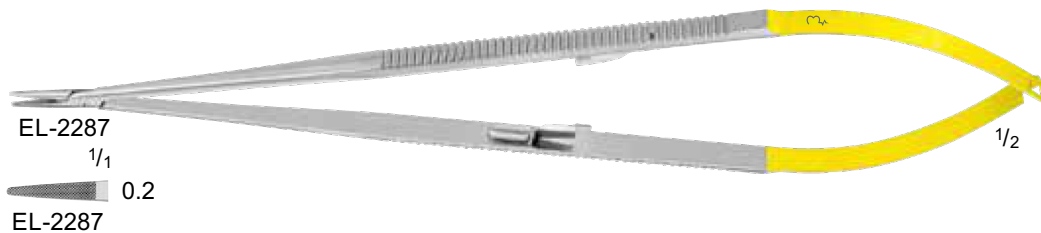

TC GIANNINI Needle Holder

Catalog Number	Jaw	Length (in.)
EL-2287	SERR	10 1/2

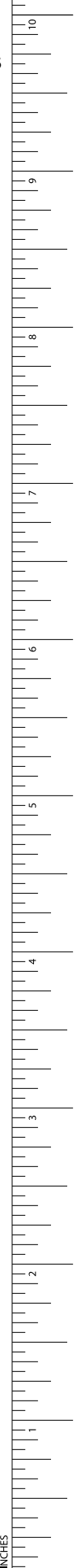

Cardiovascular

Diamond Dust Micro Needle Holders



■ Diamond dust coating ensures an even harder and more wear resistant surface on the inside of the jaws. The structure of the coating enables a reliable grip for fine needles, sutures, and tissue.



EL-2288-EL-2292

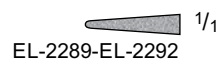
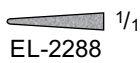

EL-2293-EL-2297

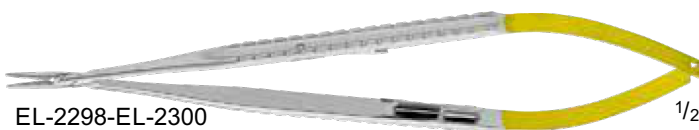
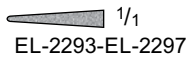

EL-2298-EL-2300

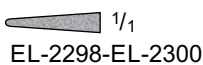

Dia Dust Micro Needle Holder, Flat Handle W/ Catch

Catalog Number	Tip	Suture Size	Length (in.)
EL-2288	STR	7/0 AND SMALLER	6 3/4
EL-2289	STR	5/0 AND SMALLER	5 3/4
EL-2290	STR	5/0 AND SMALLER	7 1/4
EL-2291	STR	5/0 AND SMALLER	8 1/4
EL-2292	STR	5/0 AND SMALLER	9

Dia Dust Micro Needle Holder, Flat Handle W/O Catch

Catalog Number	Tip	Suture Size	Length (in.)
EL-2293	STR	7/0 AND SMALLER	6 3/4
EL-2294	STR	5/0 AND SMALLER	5 3/4
EL-2295	STR	5/0 AND SMALLER	7 1/4
EL-2296	STR	5/0 AND SMALLER	8 1/4
EL-2297	STR	5/0 AND SMALLER	9

Dia Dust Micro Needle Holder, Flat Knurled Handle W/ Catch

Catalog Number	Tip	Suture Size	Length (in.)
EL-2298	STR	5/0 AND SMALLER	7 1/4
EL-2299	STR	5/0 AND SMALLER	8 1/4
EL-2300	STR	5/0 AND SMALLER	9

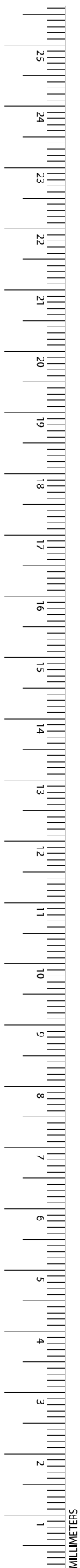

Cardiovascular

Diamond Dust Micro Needle Holders

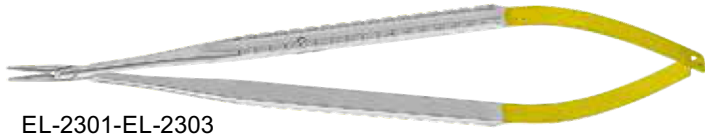

EL-2301-EL-2303



EL-2301-EL-2303

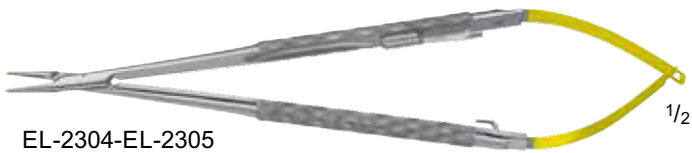

EL-2304-EL-2305



EL-2304



EL-2305



EL-2306-EL-2308



EL-2306-EL-2308



EL-2309-EL-2310



EL-2309-EL-2310

Dia Dust Micro Needle Holder, Flat Knurled Handle W/O Catch

Catalog Number	Tip	Suture Size	Length (in.)
EL-2301	STR	5/0 AND SMALLER	7 1/4
EL-2302	STR	5/0 AND SMALLER	8 1/4
EL-2303	STR	5/0 AND SMALLER	9

Dia Dust Micro Needle Holder, Golf Ball Handle Design

Catalog Number	Tip	Suture Size	Length (in.)
EL-2304	STR	7/0 AND SMALLER	7
EL-2305	CVD	7/0 AND SMALLER	7

Dia Dust Micro Needle Holder, Round Handle W/ Catch

Catalog Number	Tip	Suture Size	Length (in.)
EL-2306	STR	4/0 AND SMALLER	7 1/4
EL-2307	STR	4/0 AND SMALLER	8 1/4
EL-2308	STR	4/0 AND SMALLER	9
EL-2309	CVD	4/0 AND SMALLER	8 1/4
EL-2310	CVD	4/0 AND SMALLER	9

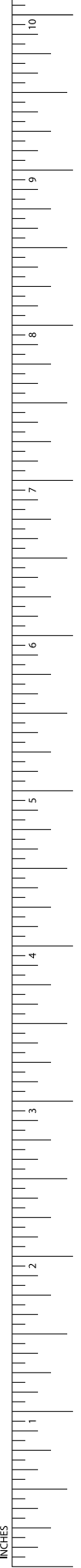

Cardiovascular

Diamond Dust Micro Needle Holders



EL-2311-EL-2320



EL-2311-EL-2315



EL-2316-EL-2320



EL-2321-EL-2330



EL-2321-EL-2325



EL-2326-EL-2330

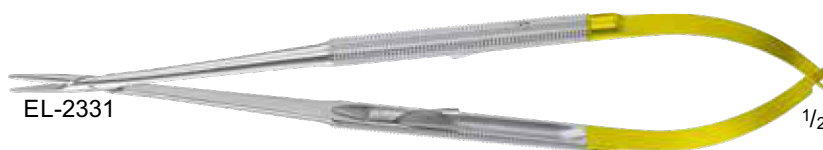

EL-2331



1/2

Dia Dust Micro Needle Holder, Round Handle W/ Catch

Catalog Number	Tip	Suture Size	Length (in.)
EL-2311	STR	7/0 AND SMALLER	4 3/4
EL-2312	STR	7/0 AND SMALLER	6 1/4
EL-2313	STR	7/0 AND SMALLER	7 1/4
EL-2314	STR	7/0 AND SMALLER	8 1/4
EL-2315	STR	7/0 AND SMALLER	9
EL-2316	STR	5/0 AND SMALLER	5 3/4
EL-2317	STR	5/0 AND SMALLER	6 1/4
EL-2318	STR	5/0 AND SMALLER	7 1/4
EL-2319	STR	5/0 AND SMALLER	8 1/4
EL-2320	STR	5/0 AND SMALLER	9

Dia Dust Micro Needle Holder, Round Handle W/O Catch

Catalog Number	Tip	Suture Size	Length (in.)
EL-2321	STR	7/0 AND SMALLER	4 3/4
EL-2322	STR	7/0 AND SMALLER	6 1/4
EL-2323	STR	7/0 AND SMALLER	7 1/4
EL-2324	STR	7/0 AND SMALLER	8 1/4
EL-2325	STR	7/0 AND SMALLER	9
EL-2326	STR	5/0 AND SMALLER	5 3/4
EL-2327	STR	5/0 AND SMALLER	6 1/4
EL-2328	STR	5/0 AND SMALLER	7 1/4
EL-2329	STR	5/0 AND SMALLER	8 1/4
EL-2330	STR	5/0 AND SMALLER	9

Dia Dust Micro Needle Holder, Round Handle W/ Catch

Catalog Number	Tip	Suture Size	Length (in.)
EL-2331	STR	5/0 AND SMALLER	8 1/4

Cardiovascular

Diamond Dust Micro Needle Holders



Dia Dust Micro Needle Holder, Round Handle W/O Catch

Catalog Number	Tip	Suture Size	Length (in.)
EL-2332	STR	5/0 AND SMALLER	8 1/4



Dia Dust Micro Needle Holder, Round Handle, Heavy, W/ Catch

Catalog Number	Tip	Description	Length (in.)
EL-2333	STR	2/0 AND SMALLER	7 1/2
EL-2334	STR	2/0 AND SMALLER	9
EL-2335	STR	2/0 AND SMALLER	9 3/4



Dia Dust Micro Needle Holder, Round Handle, Heavy, W/O Catch

Catalog Number	Tip	Suture Size	Length (in.)
EL-2336	STR	2/0 AND SMALLER	7 1/2
EL-2337	STR		9
EL-2338	STR		9 3/4



Dia Dust GLASSER Micro Needle Holder, Round Handle W/ Catch

Catalog Number	Tip	Suture Size	Length (in.)
EL-2339	STR	5/0 AND SMALLER	5
EL-2340	STR		7

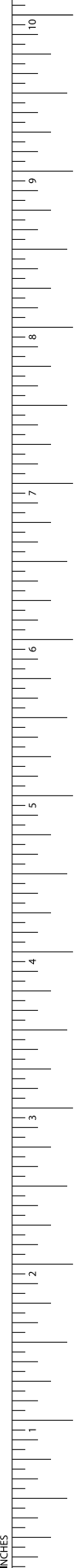

Cardiovascular

Titanium Micro Needle Holders

Elite Titanium Micro Instruments

- The extremely light Titanium material is an advantage for lengthy cardiac and vascular operations. This helps to carry on operating over longer time periods with minimum fatigue.
- The non-magnetic material makes working with particularly fine needles easier for you.
- Non-reflecting surface finish.
- Incomparable operating sensitivity: the Elite golf ball handle design.
- Unmistakable identification: the Elite color code.



All needle holder jaws are coated with Elite diamond dust coating. This coating ensures that the inner surfaces provide the best possible performance in hardness and wear resistance. The texture of the jaws greatly increases its surface area, allowing you to grasp fine needles, sutures and soft tissue safely and securely. The needle quickly aligns itself in an ideal position in the rough surface. This results in a perfect grip that quite simply prevents any needle slippage.

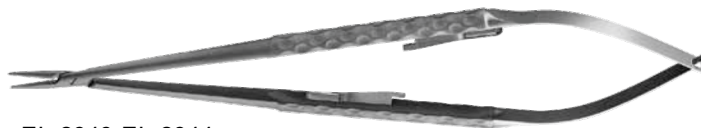

EL-2343-EL-2344



EL-2341-EL-2343



EL-2344-EL-2346



EL-2349-EL-2350



EL-2347-EL-2349



EL-2350-EL-2352

Titanium Micro Needle Holder, Golf Ball Handle Design W/ Catch

Catalog Number	Tip	Suture Size	Handle Color	Length (in.)
EL-2341	STR	7/0 AND SMALLER	GREEN	7 1/4
EL-2342	STR	7/0 AND SMALLER	GREEN	8 1/4
EL-2343	STR	7/0 AND SMALLER	GREEN	9
EL-2344	STR	5/0 AND SMALLER	BLUE	7 1/4
EL-2345	STR	5/0 AND SMALLER	BLUE	8 1/4
EL-2346	STR	5/0 AND SMALLER	BLUE	9

Titanium Micro Needle Holder, Golf Ball Handle Design W/O Catch

Catalog Number	Tip	Suture Size	Handle Color	Length (in.)
EL-2347	STR	7/0 AND SMALLER	GREEN	7 1/4
EL-2348	STR	7/0 AND SMALLER	GREEN	8 1/4
EL-2349	STR	7/0 AND SMALLER	GREEN	9
EL-2350	STR	5/0 AND SMALLER	BLUE	7 1/4
EL-2351	STR	5/0 AND SMALLER	BLUE	8 1/4
EL-2352	STR	5/0 AND SMALLER	BLUE	9

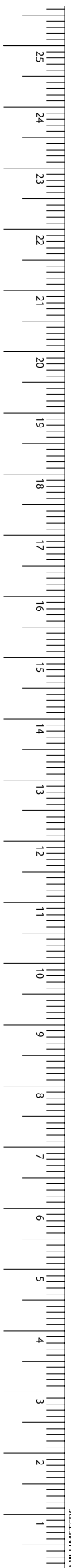

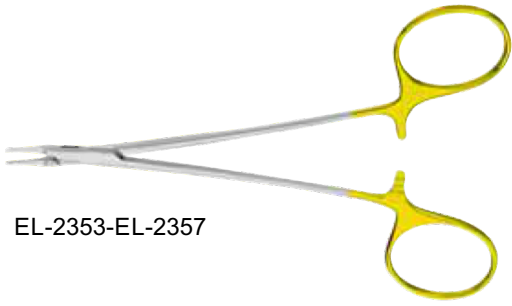

EL-2353-EL-2357



Dia Dust RYDER Needle Holder

Catalog Number	Tip	Suture Size	Length (in.)
EL-2353	X-DEL	5/0 AND SMALLER	5 1/2
EL-2354	X-DEL	5/0 AND SMALLER	7
EL-2355	X-DEL	5/0 AND SMALLER	6 1/4
EL-2356	X-DEL	5/0 AND SMALLER	8 3/4
EL-2357	X-DEL	5/0 AND SMALLER	9 3/4

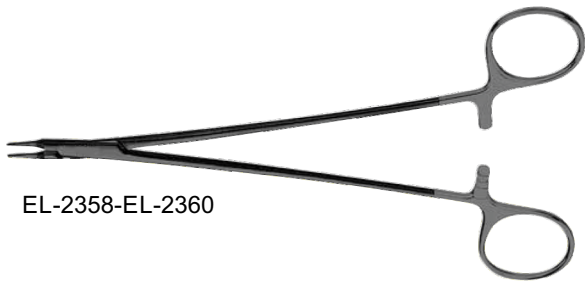

EL-2358-EL-2360



Titanium Dia Dust RYDER Needle Holder

Catalog Number	Tip	Suture Size	Length (in.)
EL-2358	X-DEL	5/0 AND SMALLER	6 1/4
EL-2359	X-DEL	5/0 AND SMALLER	7
EL-2360	X-DEL	5/0 AND SMALLER	8 1/4

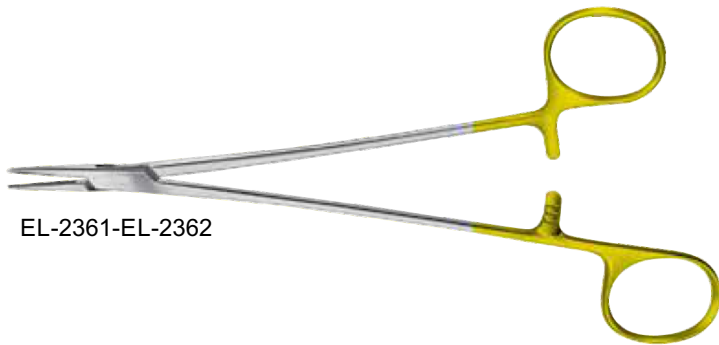

EL-2361-EL-2362

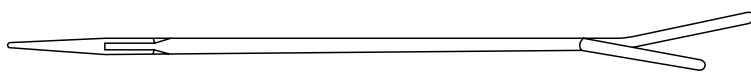

TC DEBAKEY Needle Holder, O—set

Catalog Number	Jaw	Length (in.)
EL-2361	SERR	7 3/4
EL-2362	SERR	9 5/8

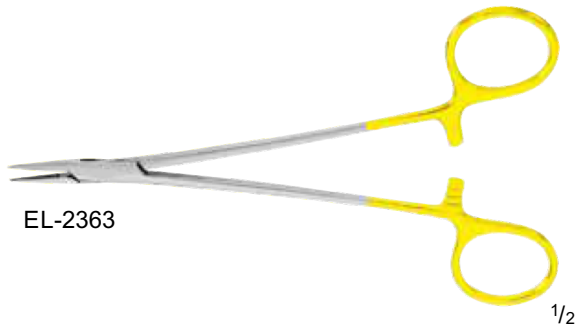

EL-2363



TC Microvascular Needle Holder

Catalog Number	Jaw	Length (in.)
EL-2363	SERR	6

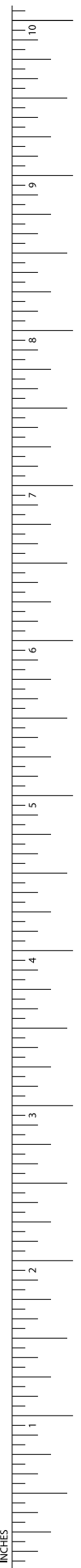

Cardiovascular TC Needle Holders

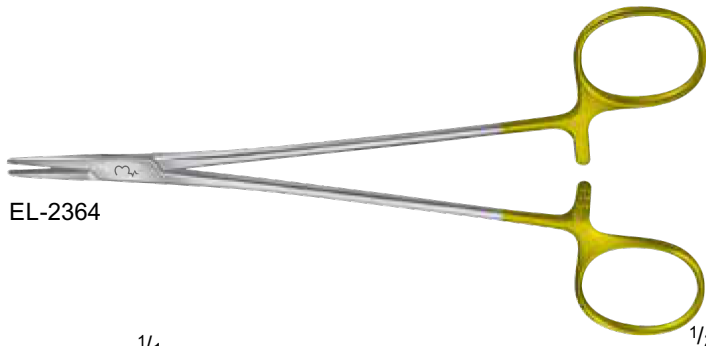
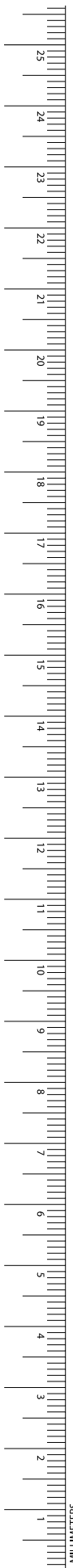

EL-2364

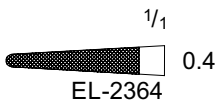

EL-2364

1/1 0.4

1/2

EL-2365-EL-2372

1/1 0.4

1/1 0.4

1/1 0.2

1/1 0.2

EL-2365

EL-2367

EL-2371

EL-2372

EL-2366-EL-2370

1/1 0.4

1/1 0.4

1/1 0.4

1/1 0.4

EL-2366

EL-2368

EL-2369

EL-2370

EL-2373

1/1 0.4

EL-2373

TC DEBAKEY Needle Holder

Catalog Number	Tip	Jaw	Length (in.)
EL-2364	DEL	SERR	6
EL-2365	DEL	SERR	6 1/2
EL-2366	DEL	SERR	7
EL-2367	DEL	SERR	8 1/4
EL-2368	DEL	SERR	9
EL-2369	DEL	SERR	10 1/4
EL-2370	DEL	SERR	12
EL-2371	X-DEL	SERR	6 1/2
EL-2372	X-DEL	SERR	8 1/4
EL-2373	X-DEL	SERR	12

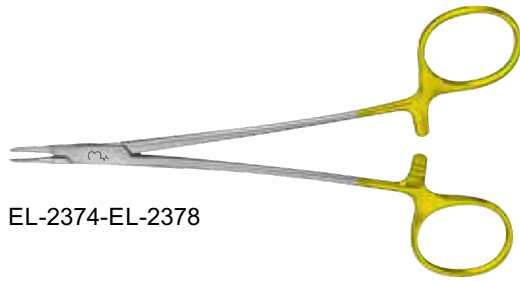
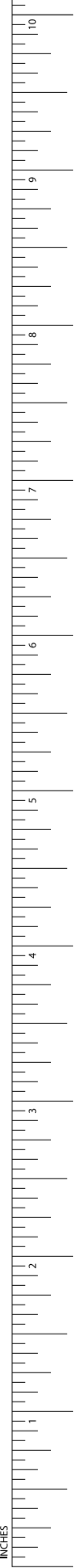

EL-2374-EL-2378

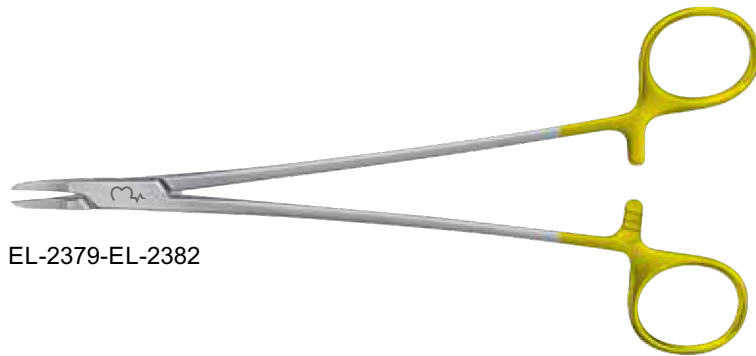
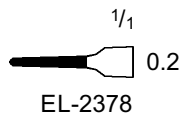
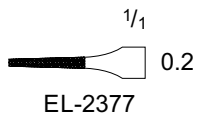
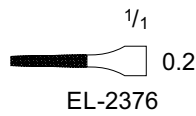
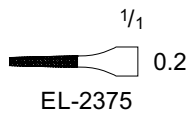
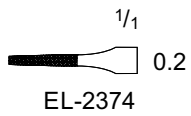

EL-2379-EL-2382

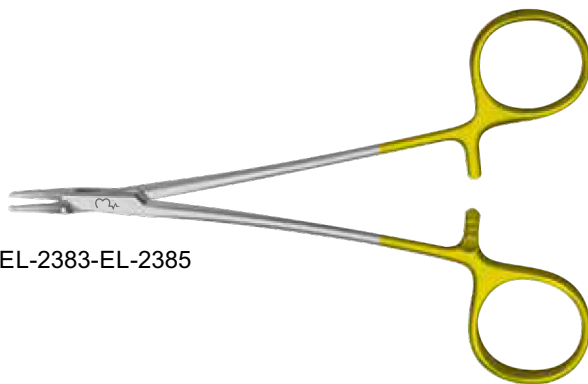
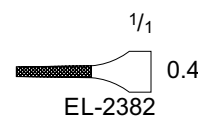
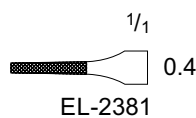
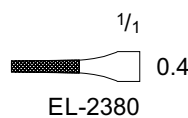
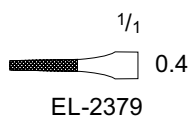

EL-2383-EL-2385

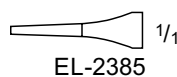
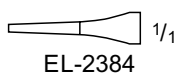
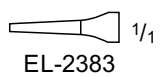

TC RYDER Needle Holder

Catalog Number	Tip	Jaw	Length (in .)
EL-2374	X-DEL	SERR	5 1/4
EL-2375	X-DEL	SERR	6 1/8
EL-2376	X-DEL	SERR	6 7/8
EL-2377	X-DEL	SERR	8 1/4
EL-2378	X-DEL	SERR	9
EL-2379	DEL	SERR	5 1/4
EL-2380	DEL	SERR	6 7/8
EL-2381	DEL	SERR	7 3/4
EL-2382	DEL	SERR	10 1/2
EL-2383	DEL	SMOOTH	6
EL-2384	DEL	SMOOTH	7
EL-2385	DEL	SMOOTH	8 7/8

Cardiovascular TC Needle Holders

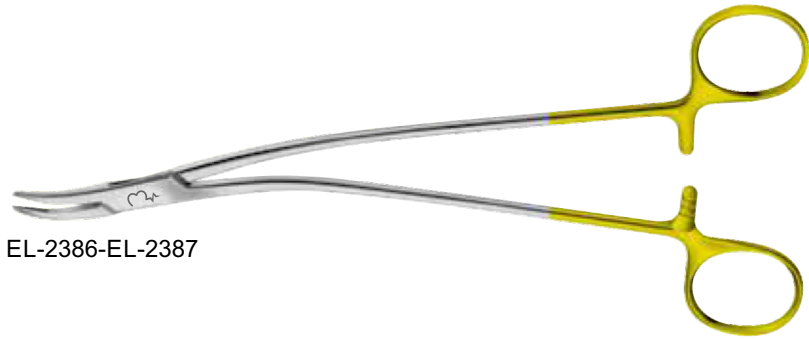
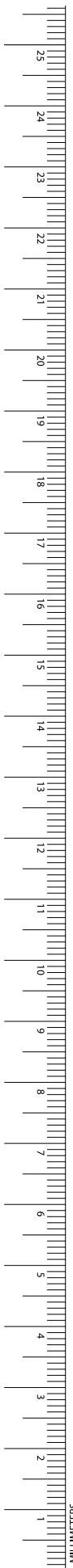

EL-2386-EL-2387

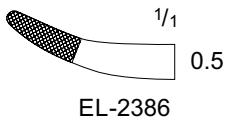

EL-2386

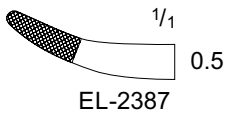

EL-2387

TC STRATTE Needle Holder

Catalog Number	Tip	Jaw	Length (in.)
EL-2386	CVD	SERR	8 1/4
EL-2387	CVD	SERR	9

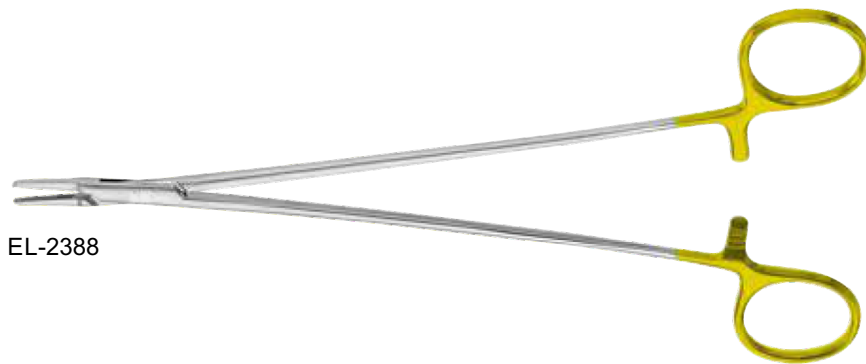

EL-2388

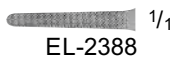

EL-2388

TC COOLEY Intracardiac Needle Holder

Catalog Number	Jaw	Length (in.)
EL-2388	SERR	9

DEBAKEY Tissue Forceps

Catalog Number	Tip Size (mm)	Length (in.)
EL-2389	2	14
EL-2390	2	16
EL-2391	3	16



EL-2389-EL-2391



EL-2392



WHEELER Vessel Forceps

Catalog Number	Tip	Length (in.)
EL-2392	SERR	6



EL-2393-EL-2395

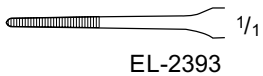

GERALD Dressing Forceps, Delicate

Catalog Number	Tip	Jaw	Length (in.)
EL-2393	STR	SERR	6 7/8
EL-2394	STR	SERR	9
EL-2395	CVD	SERR	6 7/8



EL-2396-EL-2398

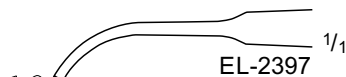
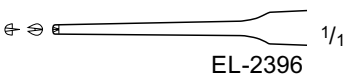

GERALD Tissue Forceps, Delicate

Catalog Number	Tip	Teeth	Length (in.)
EL-2396	STR	1 x 2	6 7/8
EL-2397	STR	1 x 2	9
EL-2398	CVD	1 x 2	6 7/8



EL-2399-EL-2401

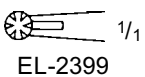

SELMAN Tissue Forceps

Catalog Number	Length (in.)
EL-2399	6 1/8
EL-2400	7 7/8
EL-2401	9 3/4

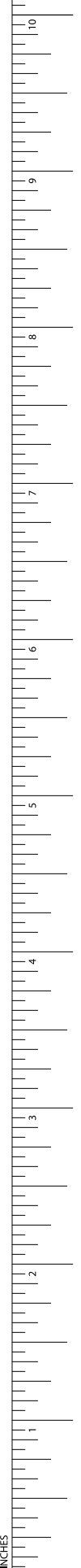

Cardiovascular Forceps

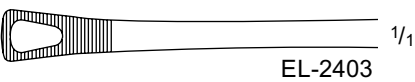
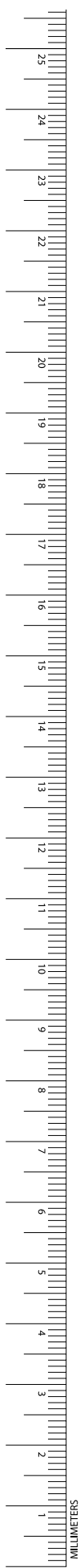

TUTTLE-SINGLEY Lung Forceps

Catalog Number	Length (in.)
EL-2402	9
EL-2403	14

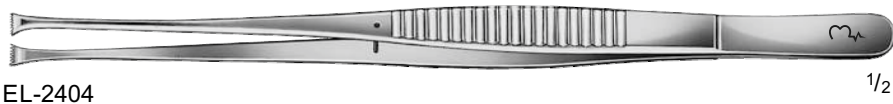

NELSON Lung Forceps

Catalog Number	Length (in.)
EL-2404	9



RESANO Cardiac Valve Forceps

Catalog Number	Tip Size (mm)	Length (in.)
EL-2405	2.5	7
EL-2406	2.5	8
EL-2407	2.5	9



RESANO Cardiac Valve Forceps

Catalog Number	Tip Size (mm)	Length (in.)
EL-2408	2	7
EL-2409	2	9
EL-2410	2	11 3/4

GERALD Micro Forceps, Flat Handle

Catalog Number	Tip	Length (in.)
EL-2411	SERR	7
EL-2412	SERR	9 3/4



EL-2411-EL-2412

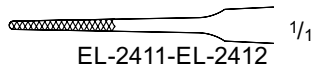

EL-2411-EL-2412



EL-2313-EL-2314

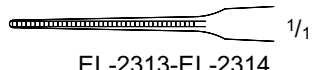

EL-2313-EL-2314

GERALD Micro Forceps, Flat Handle

Catalog Number	Tip	Length (in.)
EL-2413	DEBAKEY	7
EL-2414	DEBAKEY	7 7/8



EL-2415

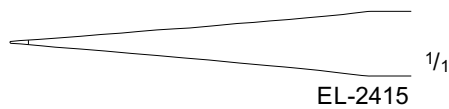

EL-2415



EL-2416

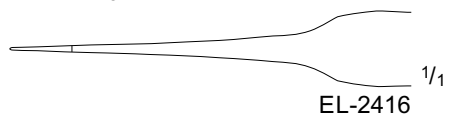

EL-2416



EL-2417

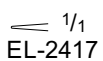

EL-2417



EL-2418

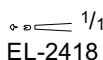

EL-2418

Micro Suture Forceps, W/ Platform

Catalog Number	Tip Size (mm)	Length (in.)
EL-2415	0.3	4 3/4
EL-2416	0.5	7 1/4

MUELLER Micro Forceps, Plastic Handle

Catalog Number	Teeth	Length (in.)
EL-2417	-	6 1/4
EL-2418	1 x 2	6 1/4

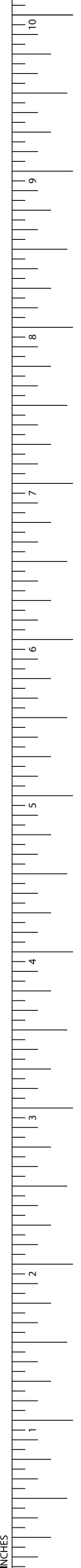

Cardiovascular Forceps

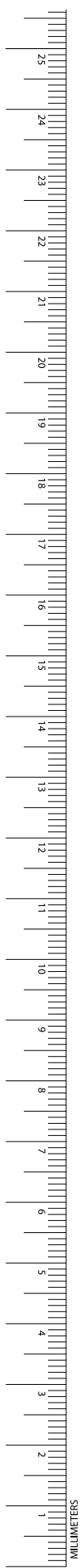

EL-2419

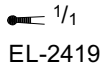

EL-2420

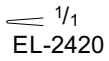

EL-2421



EL-2422-EL-2423

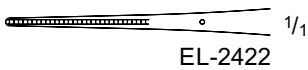

EL-2422



EL-2423



EL-2424-EL-2425

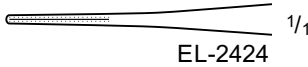

EL-2424



EL-2425



EL-2426



EL-2426

MUELLER Micro Ring Forceps, Plastic Handle

Catalog Number	Diam. of Ring (mm)	Length (in.)
EL-2419	1.2	6 1/4

MUELLER Micro Forceps, Plastic Handle, W/ Platform

Catalog Number	Length (in.)
EL-2420	6 1/4

Micro Forceps, Round Handle

Catalog Number	Tip	CountEL-balance	Length (in.)
EL-2421	CROSS-SERR	NO	7 7/8

Micro Forceps, Round Handle

Catalog Number	Tip	CountEL-balance	Length (in.)
EL-2422	DEBAKEY	NO	7 1/4
EL-2423	DEBAKEY	NO	8 1/4
EL-2424	DEBAKEY	YES	7 1/4
EL-2425	DEBAKEY	YES	8 1/4

TC (POTTS-SMITH) Thumb Forceps

Catalog Number	Tip	Length (in.)
EL-2426	X-SERR	5 3/4



The diamond dust coating ensures an even harder and more wear resistant surface on the inside of the jaws. The structure of the coating enables a reliable grip for needles, sutures, and tissue.



EL-2427-EL-2428



EL-2427

EL-2428



EL-2429-EL-2430

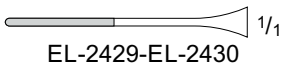

EL-2429-EL-2430



EL-2431-EL-2432



EL-2431-EL-2432



EL-2433



EL-2433

Dia Dust GERALD Micro Ring Forceps, Flat Handle

Catalog Number	Diam. of Ring (mm)	Tip	Length (in.)
EL-2427	1.0	STR	7
EL-2428	1.0	CVD	7

Dia Dust GERALD Micro Forceps, Flat Handle

Catalog Number	Tip	Tip Size (mm)	Length (in.)
EL-2429	STR	1.0	7
EL-2430	STR	1.0	7 7/8

Dia Dust THUMB Forceps, Flat Handle

Catalog Number	Tip	Tip Size (mm)	Length (in.)
EL-2431	STR	1.0	7
EL-2432	STR	1.0	8 1/4

Dia Dust Micro Forceps W/ Platform

Catalog Number	Tip	Count EL-balance	Length (in.)
EL-2433	STR	NO	7

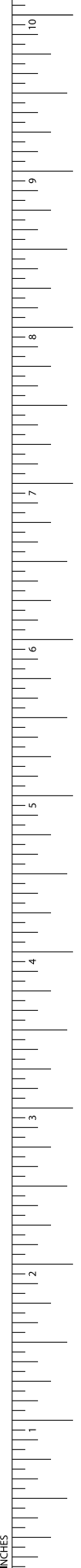

Cardiovascular

Diamond Dust

Forceps



EL-2434-EL-2435



EL-2434-EL-2435



EL-2436-EL-2437



EL-2436-EL-2437



EL-2438

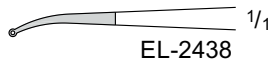

EL-2438



EL-2439-EL-2440



EL-2439-EL-2440



EL-2441-EL-2442



EL-2441-EL-2442

Dia Dust Micro Ring Forceps, Round Handle

Catalog Number	Diam. of Ring (mm)	Tip	CountEL-balance	Length (in.)
EL-2434	2.5	STR	NO	7
EL-2435	2.5	STR	NO	7 7/8

Dia Dust Micro Ring Forceps, Round Handle

Catalog Number	Diam. of Ring (mm)	Tip	CountEL-balance	Length (in.)
EL-2436	1.0	STR	NO	7 1/4
EL-2437	1.0	STR	NO	8 1/4
EL-2438	1.0	CVD	NO	7 1/4

Dia Dust Micro Ring Forceps, W/ Platform, Round Handle

Catalog Number	Diam. of Ring (mm)	Tip	CountEL-balance	Length (in.)
EL-2439	1.0	STR	NO	7 1/4
EL-2440	1.0	STR	NO	8 1/4

Dia Dust Micro Forceps, W/ Platform, Round Handle

Catalog Number	Tip	CountEL-balance	Length (in.)
EL-2441	STR	NO	7 1/4
EL-2442	STR	NO	8 1/4

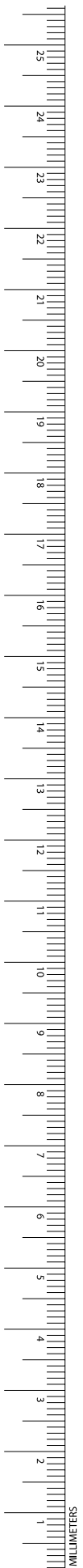

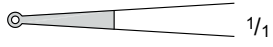

 1/1
EL-2443-EL-2447

 1/1
EL-2448

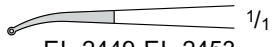

EL-2449-EL-2453

 1/1
EL-2449-EL-2453

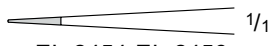

EL-2454-EL-2456

 1/1
EL-2454-EL-2456



EL-2458-EL-2461

 1/1
EL-2458-EL-2461

Dia Dust Micro Ring Forceps, Round Handle

Catalog Number	Diam. of Ring (mm)	Tip	CountEL-balance	Length (in.)
EL-2443	1.0	STR	YES	6
EL-2444	1.0	STR	YES	7 1/4
EL-2445	1.0	STR	YES	8 1/4
EL-2446	1.0	STR	YES	9
EL-2447	1.0	STR	YES	9 3/4
EL-2448	2.0	STR	YES	7 1/4
EL-2449	1.0	CVD	YES	6
EL-2450	1.0	CVD	YES	7 1/4
EL-2451	1.0	CVD	YES	8 1/4
EL-2452	1.0	CVD	YES	9
EL-2453	1.0	CVD	YES	9 3/4

Dia Dust Micro Forceps, W/ Platform, Round Handle

Catalog Number	Tip	CountEL-balance	Length (in.)
EL-2454	STR	YES	6
EL-2455	STR	YES	7 1/4
EL-2456	STR	YES	8 1/4
EL-2457	STR	YES	9 3/4
EL-2458	CVD	YES	6
EL-2459	CVD	YES	7 1/4
EL-2460	CVD	YES	8 1/4
EL-2461	CVD	YES	9 3/4

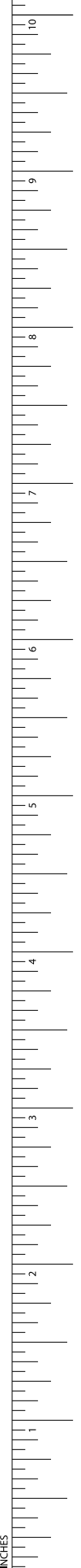

Cardiovascular

Titanium Forceps

Elite Titanium Micro Instruments

- The extremely light Titanium material is an advantage for lengthy cardiac and vascular operations. This helps to carry on operating over longer time periods with minimum fatigue.
- Non-reflecting surface finish - for optimal glare reduction.
- The Elite golf ball handle design - gives incomparable operating sensitivity.
- The Elite color code - provides unmistakable instrument identification.



All titanium forceps jaws are coated with Elite diamond dust coating. This coating ensures that the inner surfaces provide the best possible performance in hardness and wear resistance. The texture of the jaws greatly increases its surface area, allowing you to grasp sutures and soft tissue safely and securely.



EL-2462-EL-2464

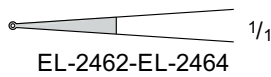

EL-2462-EL-2464



EL-2465-EL-2467

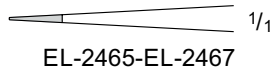

EL-2465-EL-2467



EL-2468-EL-2470



EL-2468-EL-2470

Titanium Micro Ring Forceps, Golf Ball Handle

Catalog Number	Diam. of Ring (mm)	Tip	Handle Color	CountEL-balance	Length (in.)
EL-2462	1.0	DIA DUST	BLUE	NO	7 1/4
EL-2463	1.0	DIA DUST	BLUE	NO	8 1/4
EL-2464	1.0	DIA DUST	BLUE	NO	9

Titanium Micro Forceps, W/ Platform, Golf Ball Handle

Catalog Number	Tip	Handle Color	CountEL-balance	Length (in.)
EL-2465	DIA DUST	GREEN	NO	7 1/4
EL-2466	DIA DUST	GREEN	NO	8 1/4
EL-2467	DIA DUST	GREEN	NO	9

Titanium Micro Forceps, Golf Ball Handle

Catalog Number	Tip	Handle Color	CountEL-balance	Length (in.)
EL-2468	DEBAKEY	PURPLE	NO	7 1/4
EL-2469	DEBAKEY	PURPLE	NO	8 1/4
EL-2470	DEBAKEY	PURPLE	NO	9

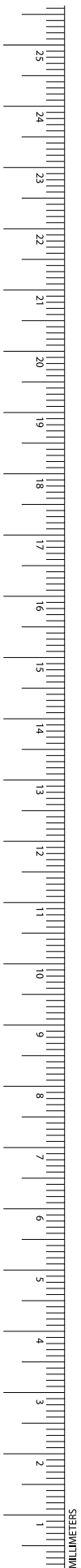

Titanium Standard Forceps

- Non-reflecting surface finish.
- Fatigue-free lightness.
- Blue handle for definite identification of an Elite Titanium Instrument.



EL-2471-EL-2473



EL-2471-EL-2473



EL-2474-EL-2476



EL-2474-EL-2476



EL-2477



EL-2477



EL-2478



EL-2478



EL-2479



EL-2479

Titanium DEBAKEY Atraumatic Forceps

Catalog Number	Tip Size (mm)	Length (in.)
EL-2471	1.5	5 3/4
EL-2472	1.5	7 3/4
EL-2473	1.5	9 1/2
EL-2474	2.5	5 3/4
EL-2475	2.5	7 3/4
EL-2476	2.5	9 1/2

Titanium Micro ADSON Dissecting Forceps

Catalog Number	Tip	Length (in.)
EL-2477	SERR	4 3/4

Titanium Micro ADSON Tissue Forceps, Delicate

Catalog Number	Tip	Teeth	Length (in.)
EL-2478	SERR	1 x 2	4 3/4

Titanium Micro ADSON Tissue Forceps

Catalog Number	Tip	Teeth	Length (in.)
EL-2479	SERR	1 x 2	4 3/4

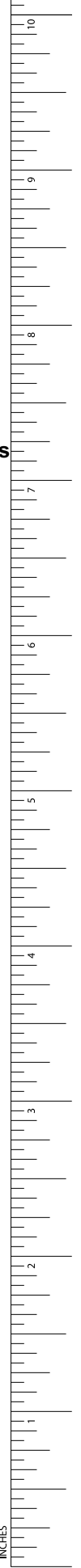

Cardiovascular Titanium Clamps



EL-2480



EL-2480



EL-2481



EL-2481



EL-2482



EL-2482

Titanium GERALD Dissecting Forceps, Delicate

Catalog Number	Tip	Length (in.)
EL-2480	SERR	6 3/4

Titanium GERALD Tissue Forceps

Catalog Number	Tip	Teeth	Length (in.)
EL-2481	SERR	1 x 2	6 3/4

Titanium RESANO Grasping Forceps

Catalog Number	Tip	Length (in.)
EL-2482	SERR	9

Titanium Ringhanded Instruments

- Non-reflecting surface finish.
- Fatigue-free lightness.
- Blue rings for denite identification of an Elite Titanium Instrument.

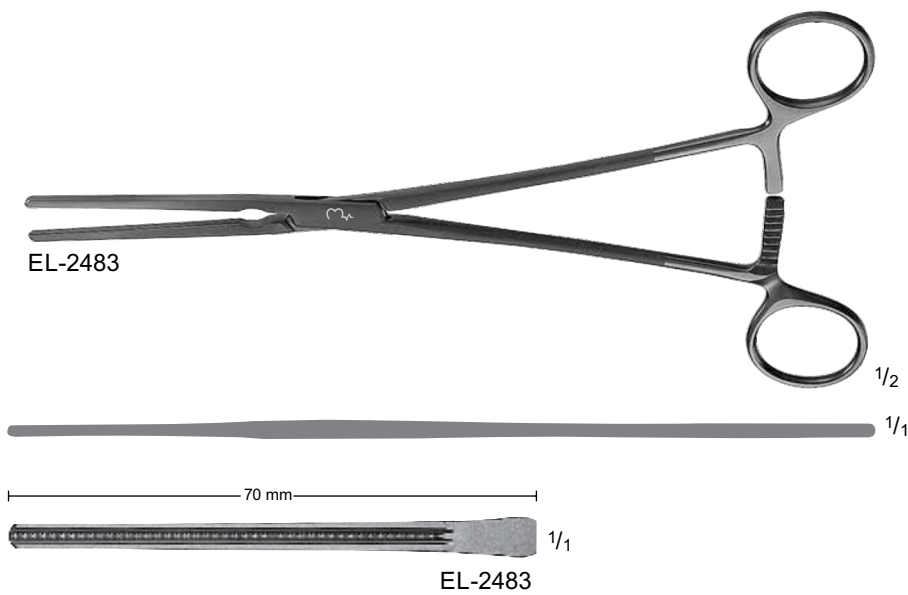

Titanium DEBAKEY Atraumatic Vascular Clamp

Catalog Number	Jaw	Jaw Length (mm)	Length (in.)
EL-2483	STR	70	9

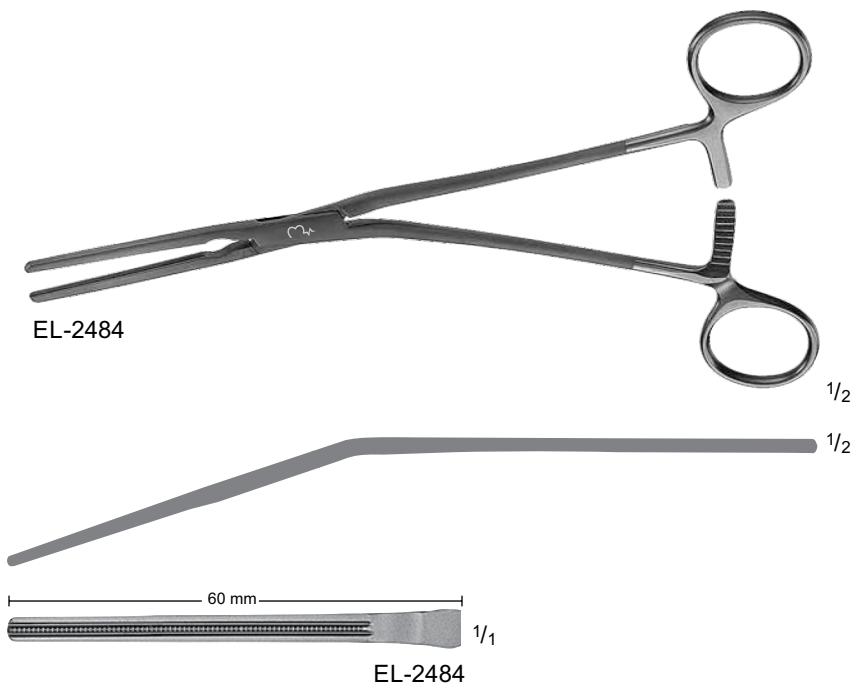

Titanium DEBAKEY Atraumatic Vascular Clamp

Catalog Number	Jaw	Jaw Length (mm)	Shaft	Length (in.)
EL-2484	STR	60	ANG	8 1/2

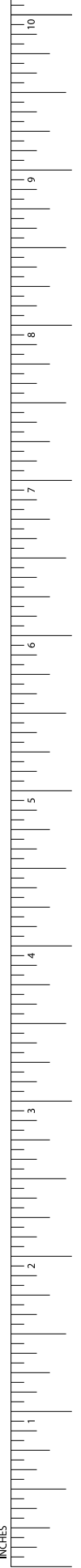

Cardiovascular

Titanium Clamps

Titanium DEBAKEY Atraumatic Vascular Clamp

Catalog Number	Jaw	Jaw Length (mm)	Length (in.)
EL-2485	CVD	70	8 7/8
EL-2486	CVD	75	9 5/8



EL-2485-EL-2486

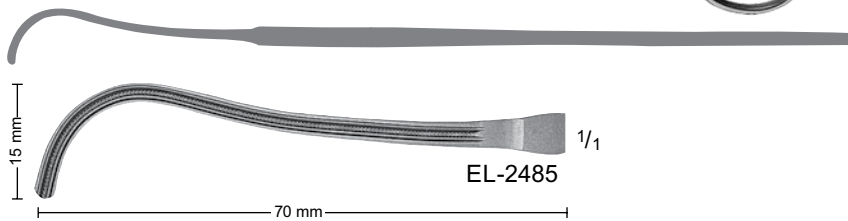

EL-2485

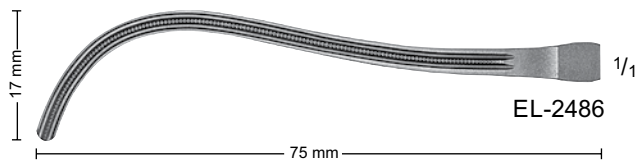

EL-2486

Titanium GLOVER Atraumatic Vascular Clamp

Catalog Number	Jaw	Jaw Length (mm)	Length (in.)
EL-2487	CVD	60	8 3/4
EL-2488	CVD	80	10 5/8

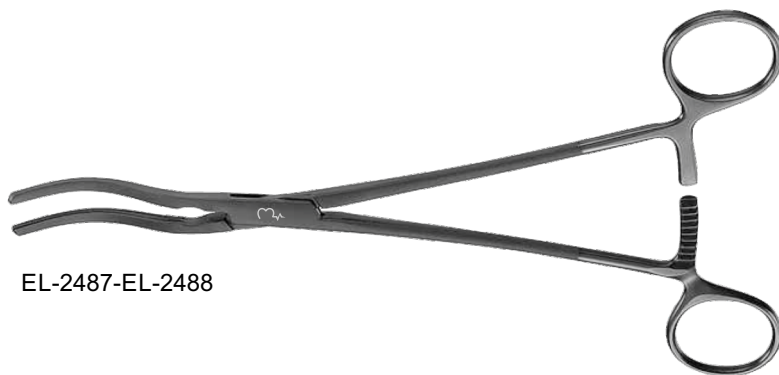

EL-2487-EL-2488

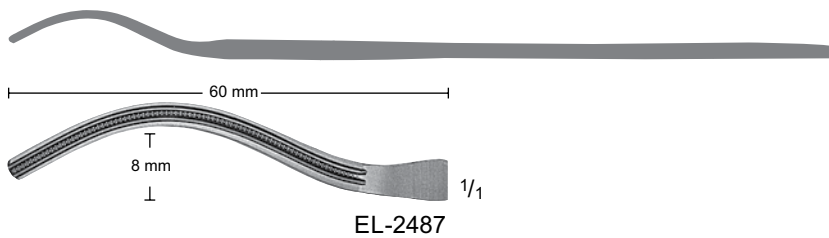

EL-2487

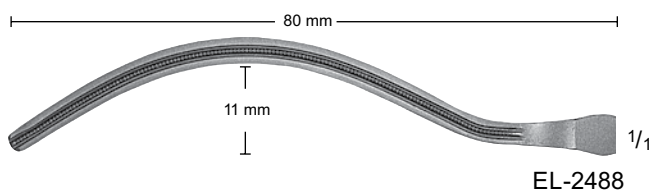

EL-2488

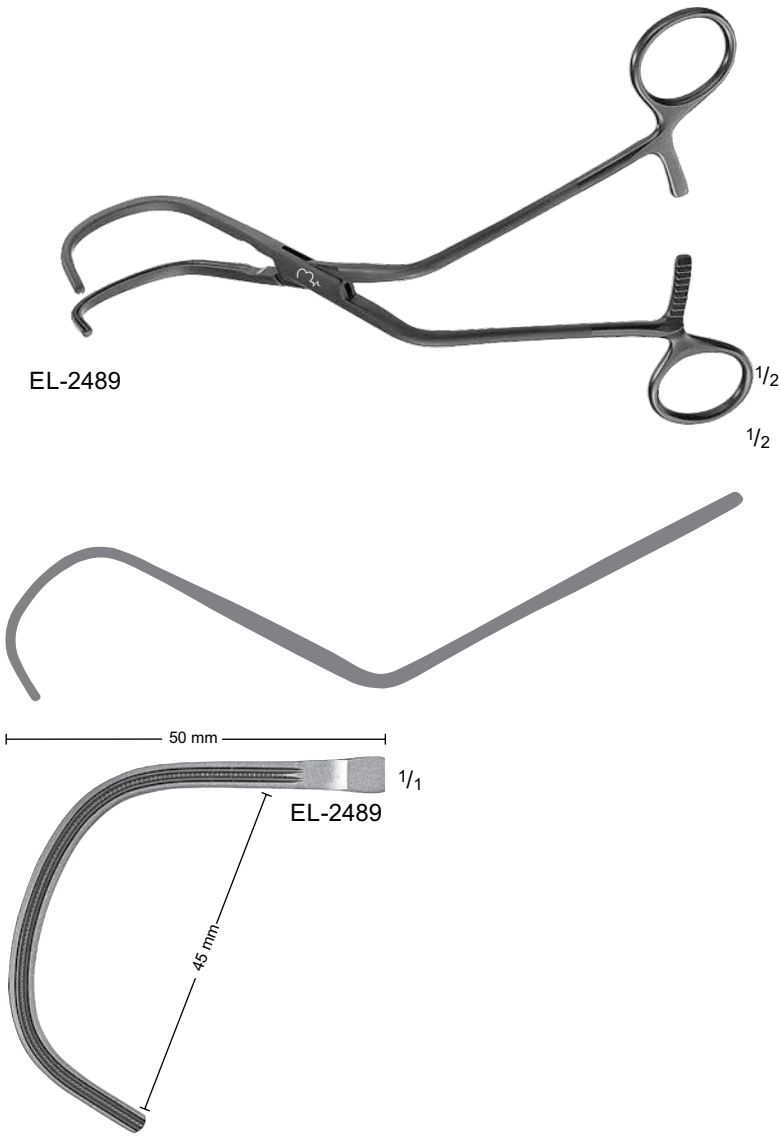

Titanium LAMBERT-KAY Atraumatic Vascular Clamp

Catalog Number	Jaw Angle	Jaw Length (mm)	Shaft	Length (in.)
EL-2489	MULTI	45	ANG	7 3/4

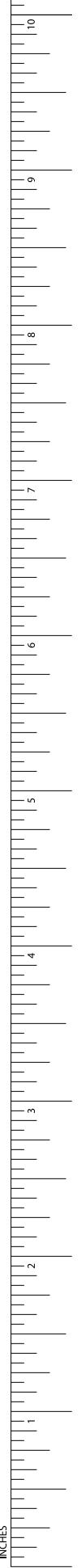

Cardiovascular
Titanium Clamps

**Titanium DEBAKEY Atraumatic
Vascular Clamp**

Catalog Number	Jaw	Length (in.)
EL-2490	SLIGHT-CVD	12 1/4
EL-2491	SLIGHT-CVD	12 1/2



EL-2490-EL-2491

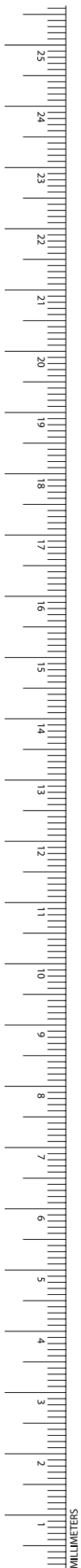
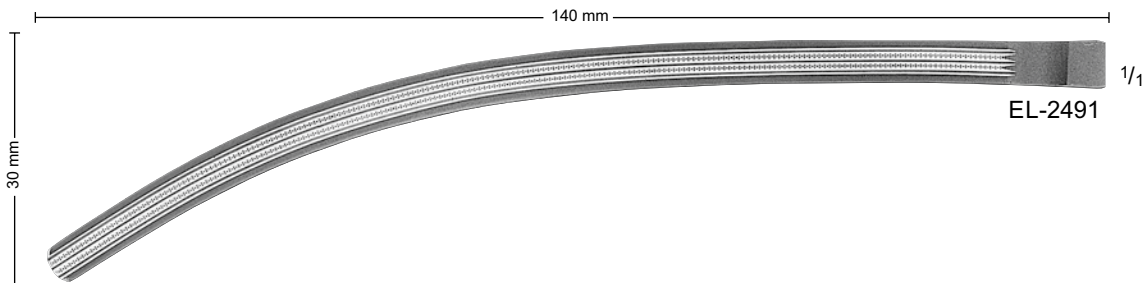
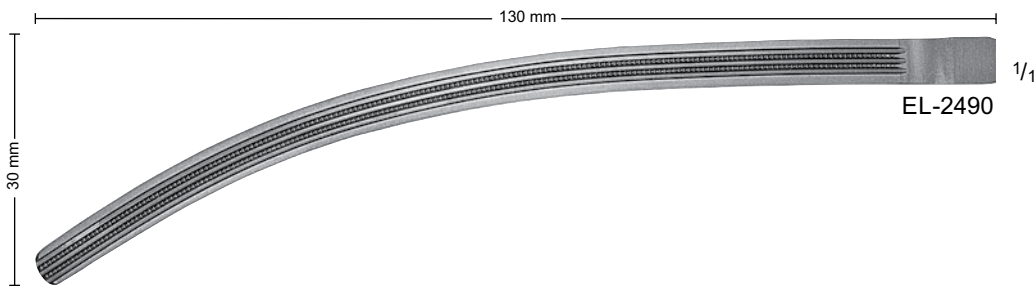



EL-2492-EL-2493

Titanium DEBAKEYAtraumatic Vascular Clamp

Catalog Number	Jaw	Shaft	Length (in.)
EL-2492	CVD	ANG	7 3/4
EL-2493	ANG	ANG	7

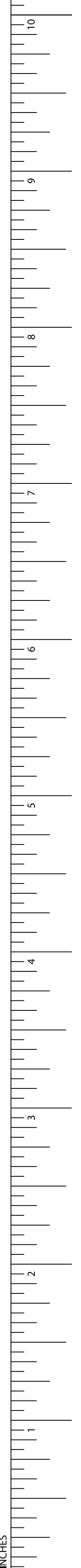
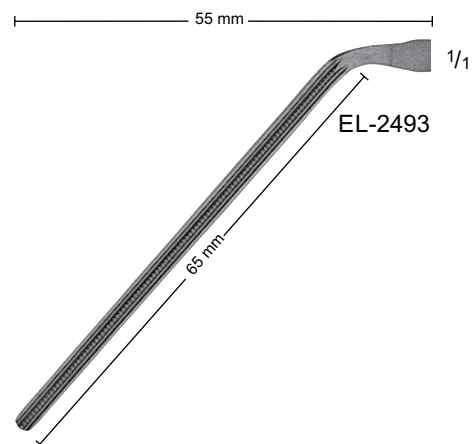
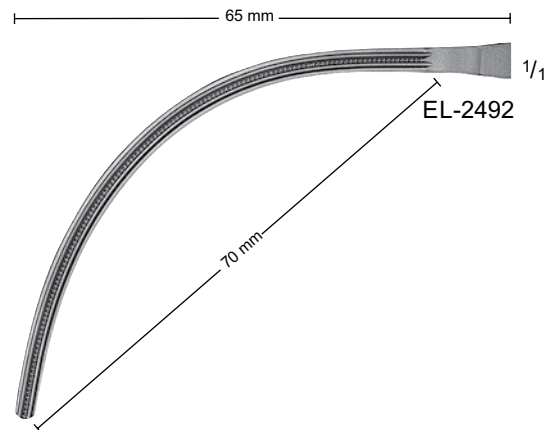

Cardiovascular
Titanium Clamps

**Titanium DEBAKEY Atraumatic
Vascular Clamp**

Catalog Number	Jaw	Length (in.)
EL-2494	HEAVY-CVD	10 1/4

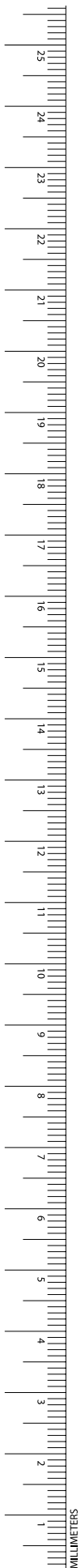
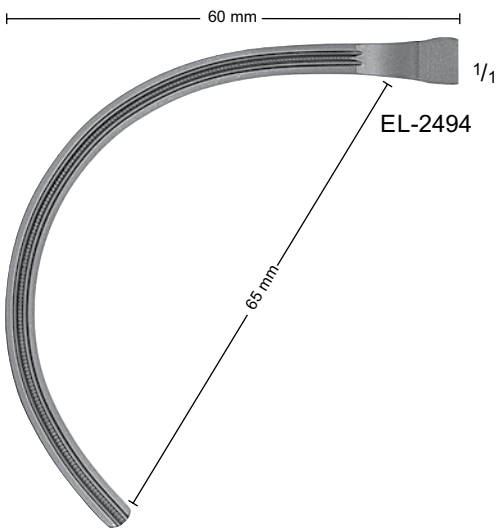

**Titanium DEBAKEYAtraumatic
Vascular Clamp**

Catalog Number	Jaw	Shaft	Length (in.)
EL-2495	ANG	ANG	9 1/2
EL-2496	ANG	ANG	8 1/2

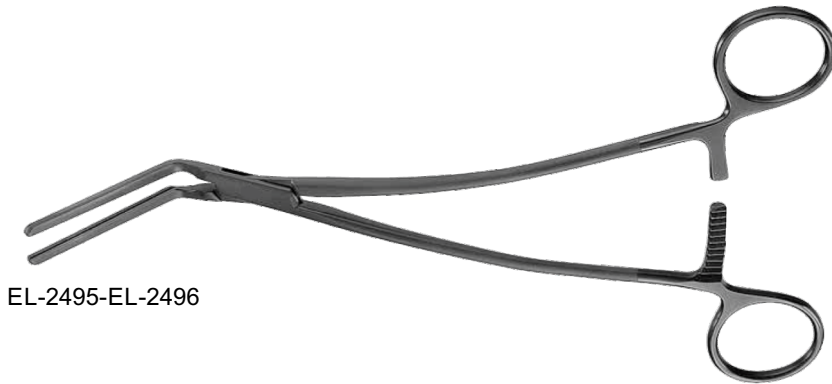

EL-2495-EL-2496

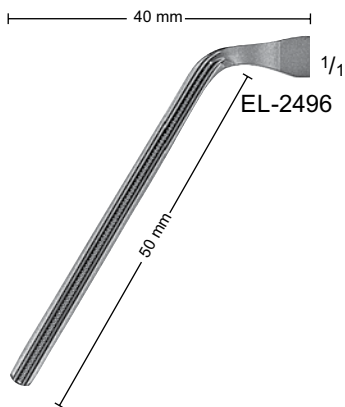
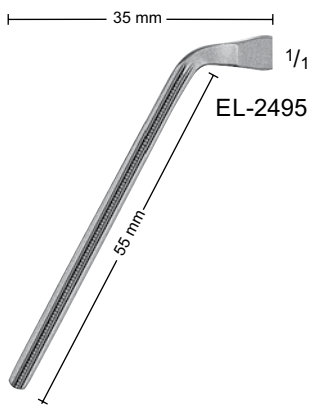

Cardiovascular
Titanium Clamps

Titanium DEBAKEY-SATINSKY
Atraumatic Vascular Clamp

Catalog Number	Jaw Angle	Shaft	Length (in.)
EL-2497	MULTI	ANG	7 7/8
EL-2498	MULTI	ANG	9 5/8
EL-2499	MULTI	ANG	9 3/4



EL-2497-EL-2499

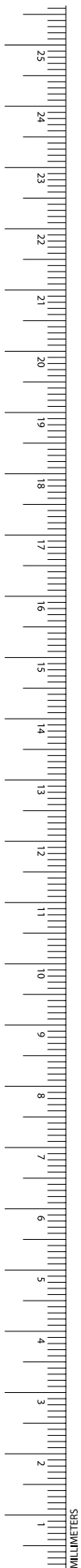
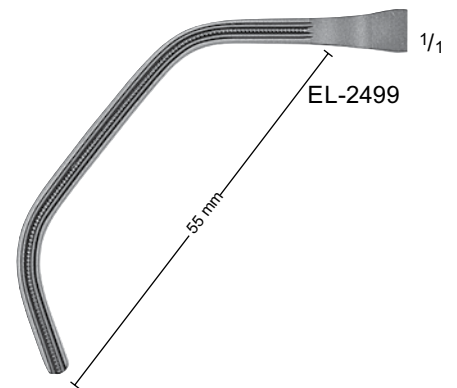
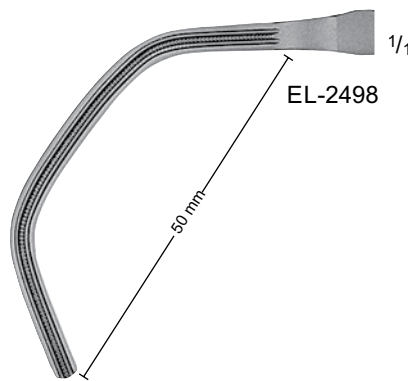
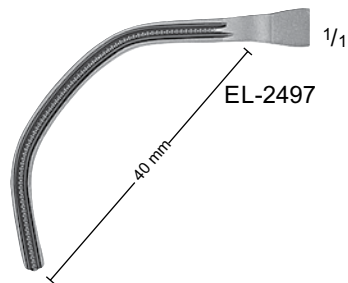

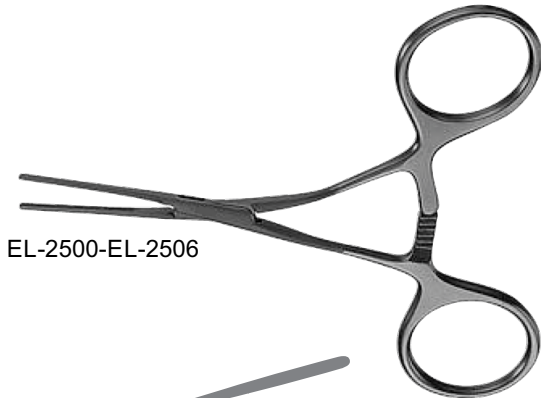

EL-2500-EL-2506

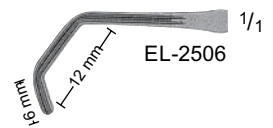
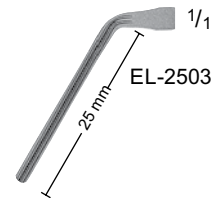
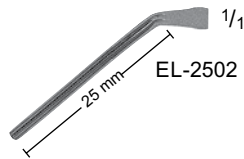
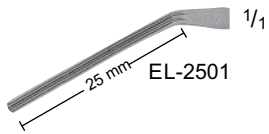
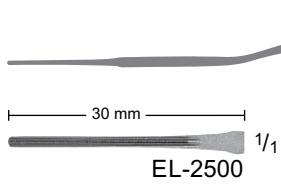

Titanium DEBAKEYAtraumatic Pediatric Vascular Clamp

Catalog Number	Jaw Angle	Length (in.)
EL-2500	STR	4 1/4
EL-2501	30°	4 1/4
EL-2502	45°	4 1/4
EL-2503	60°	4 1/4
EL-2504	MULTI	3 3/4
EL-2505	MULTI	4
EL-2506	MULTI	4

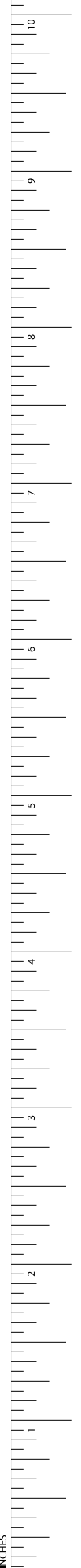

Cardiovascular Forceps and Clamps

Chest Tube Passer

Catalog Number	Description	Length (in.)
EL-2507	W/O RATCHET	9 3/4
EL-2508	W/O RATCHET	14
EL-2509	W/ RATCHET	9 3/4



EL-2507-EL-2508



EL-2507-EL-2508



EL-2509

1/2



EL-2509

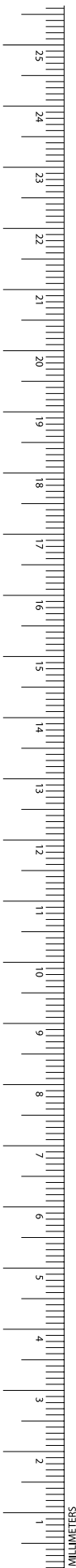

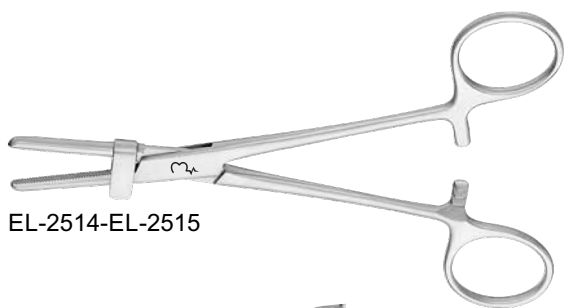
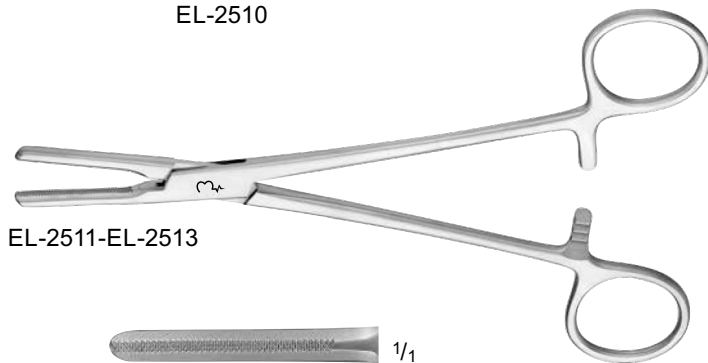

Tubing Clamp

Catalog Number	Jaw	Length (in.)
EL-2510	SMOOTH	6 1/2
EL-2511	SERR	6
EL-2512	SERR	7
EL-2513	SERR	7 7/8

Tubing Clamp, W/ Guard

Catalog Number	Jaw	Length (in.)
EL-2514	SERR	6
EL-2515	SERR	7
EL-2516	SERR	7 7/8

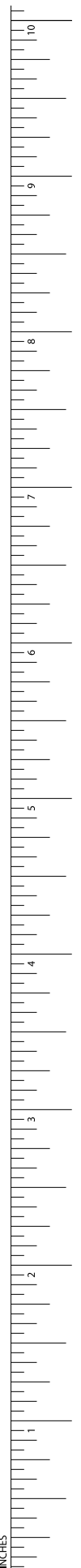

Cardiovascular Forceps and Clamps

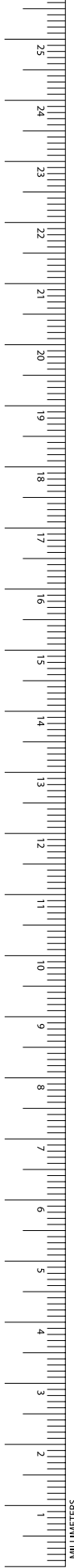

SAROT Forceps, Delicate

Catalog Number	Teeth	Length (in.)
EL-2517	-	9 1/2
EL-2518	1 x 2	9 1/2

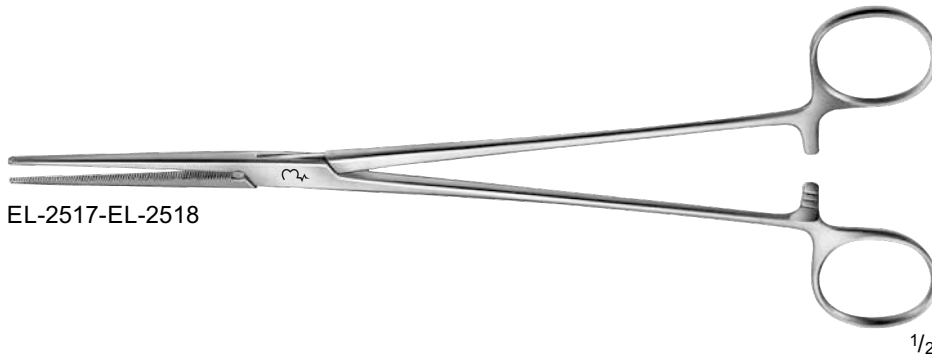

EL-2517-EL-2518

1/2



EL-2517

1/1



EL-2518

1/1

CRAFOORD Forceps, Delicate

Catalog Number	Jaw	Length (in.)
EL-2519	CVD	9 5/8

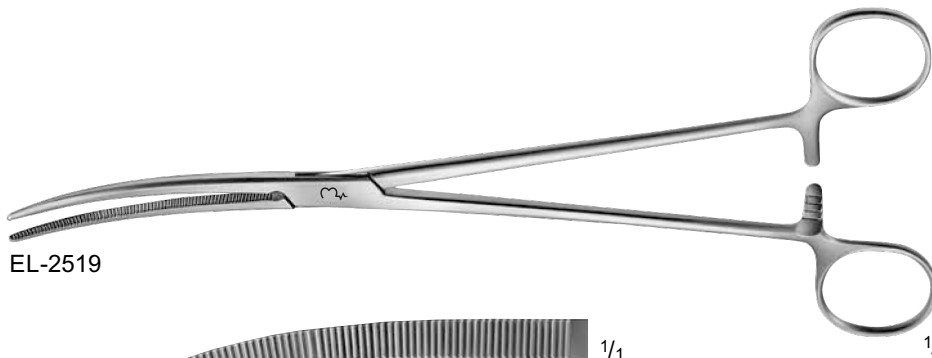

EL-2519

1/2



EL-2519

1/1

HOLLE Forceps, Delicate

Catalog Number	Jaw	Length (in.)
EL-2520	CVD	5 3/4
EL-2521	CVD	7 1/4
EL-2522	CVD	9 1/4

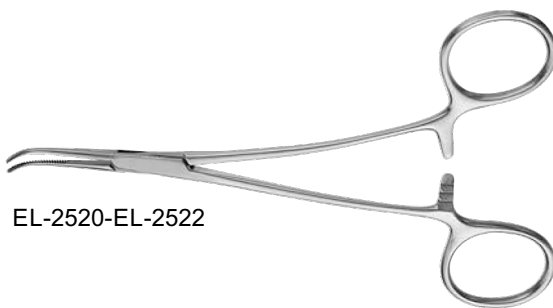

EL-2520-EL-2522



EL-2520

1/1



EL-2521

1/1



EL-2522

1/1

COLLER Artery Forceps

Catalog Number	Jaw Angle	Length (in.)
EL-2523	90°	9 1/2

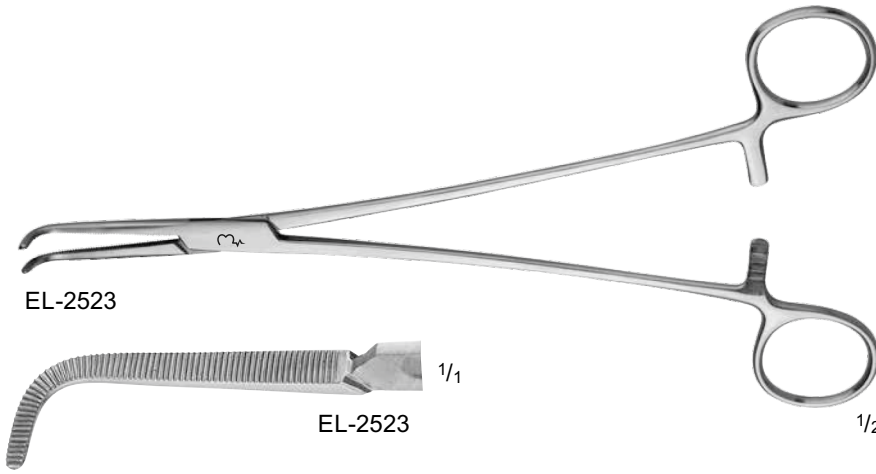

SAROT Intrathoracic Artery Forceps

Catalog Number	Jaw	Length (in.)
EL-2524	SLIGHT-CVD	9 3/4

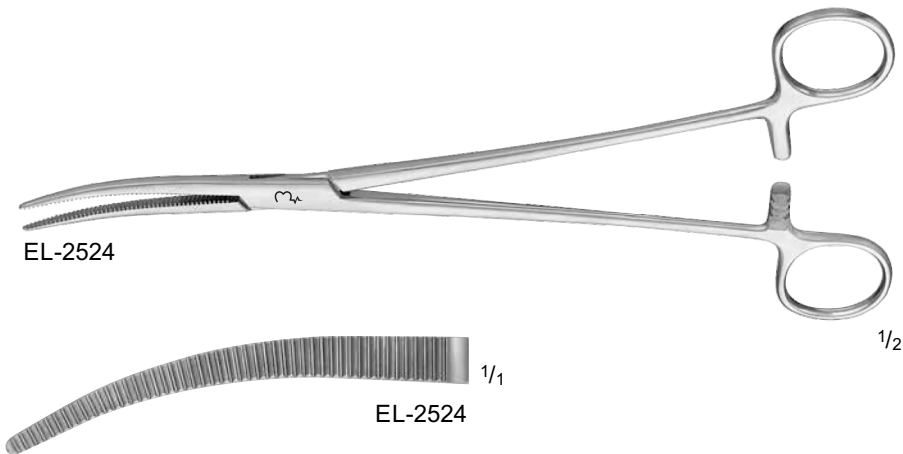

JULIAN Thoracic Artery Forceps

Catalog Number	Jaw	Length (in.)
EL-2525	CVD	9 1/4

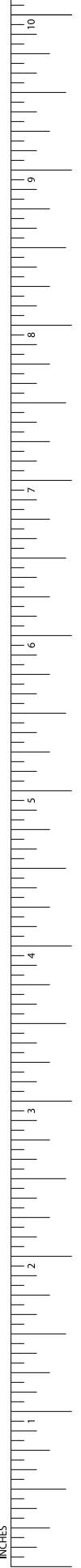
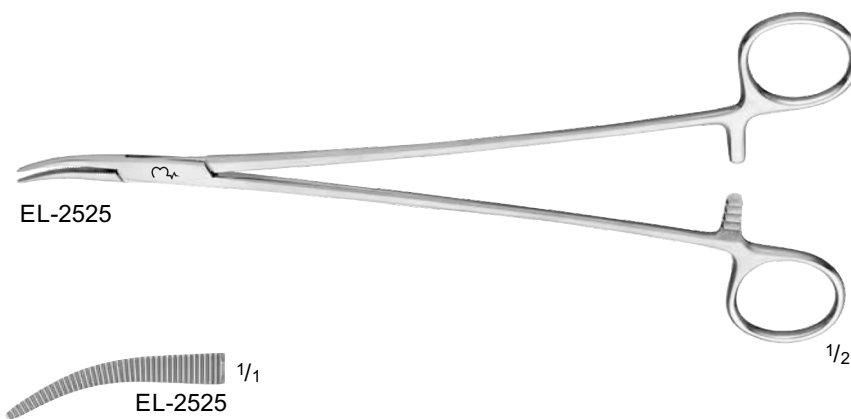

Cardiovascular Forceps and Clamps

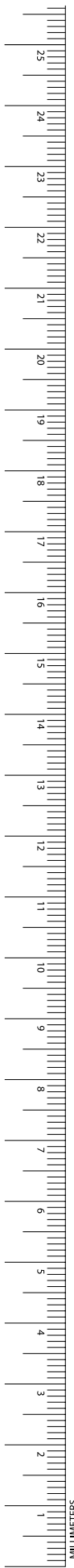

EL-2526

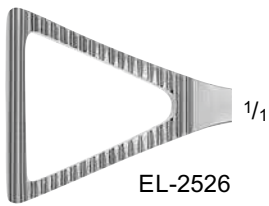

EL-2526

LOVELACE Lung Forceps

Catalog Number	Length (in.)
EL-2526	8

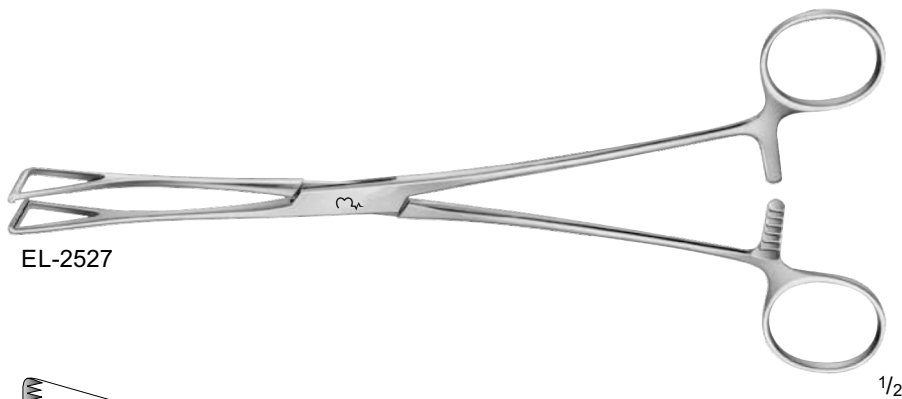

EL-2527

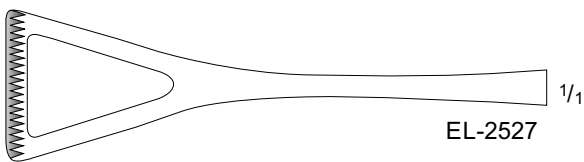

EL-2527

DUVAL Lung Forceps

Catalog Number	Length (in.)
EL-2527	9



EL-2528



EL-2528

BABCOCK Thoracic Tissue Forceps

Catalog Number	Length (in.)
EL-2528	9 1/2

Thoracoscopy Forceps

Catalog Number	Jaw	Jaw Length (mm)	Length (in.)
EL-2529	STR, LONG	158	12 1/2
EL-2530	CVD, LONG	158	12 1/4

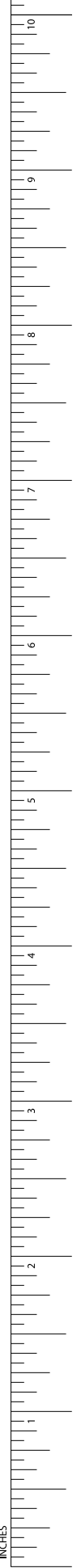
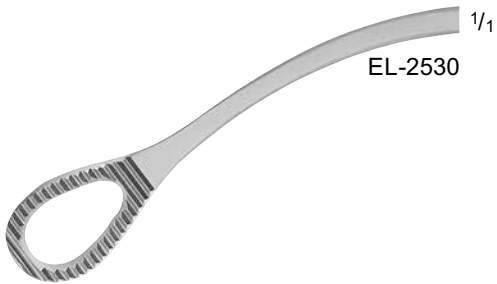
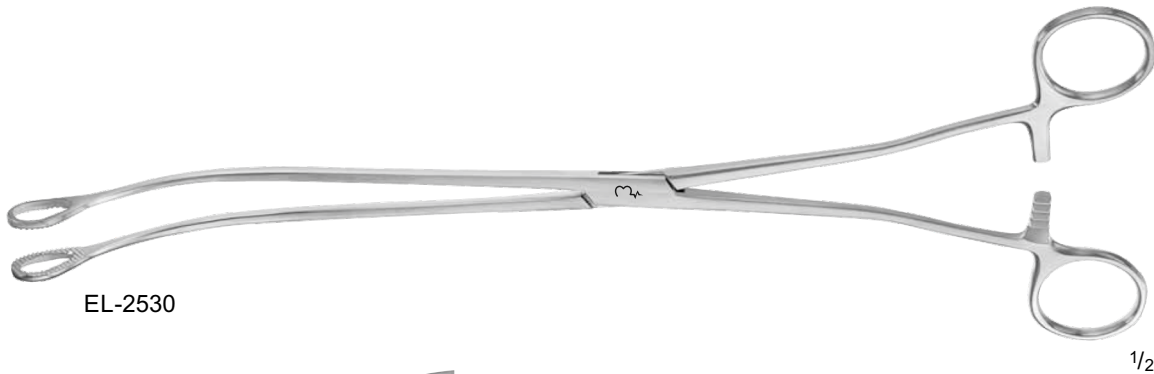

Cardiovascular Forceps and Clamps

ROCHESTEL-OCHSNER Artery Forceps

Catalog Number	Jaw	Teeth	Length (in.)
EL-2531	STR	1 x 2	14

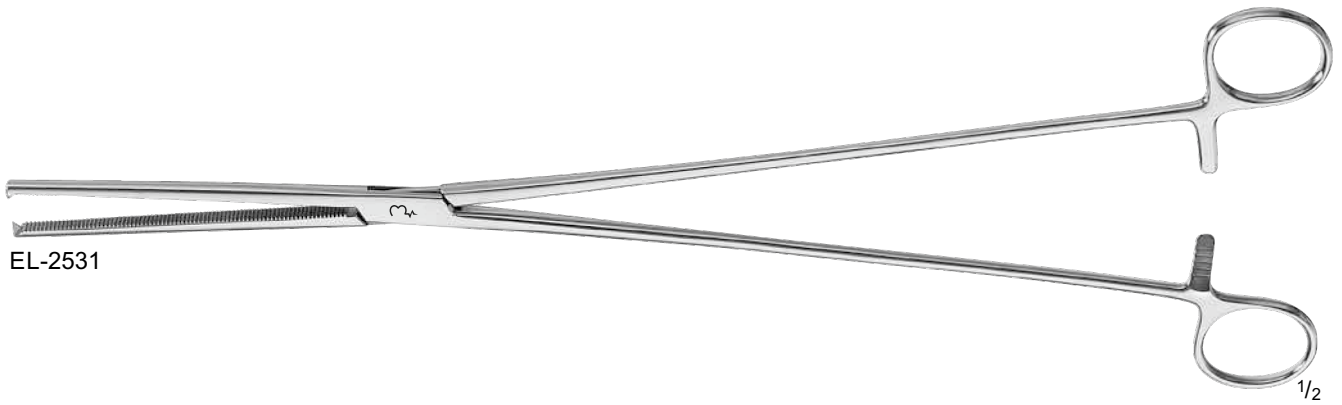

CARMALT Artery Forceps, Longitudinal Serrations

Catalog Number	Jaw	Length (in.)
EL-2532	SLIGHT-CVD	12

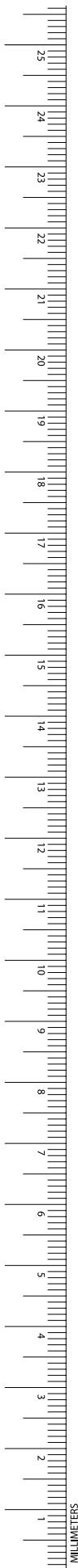
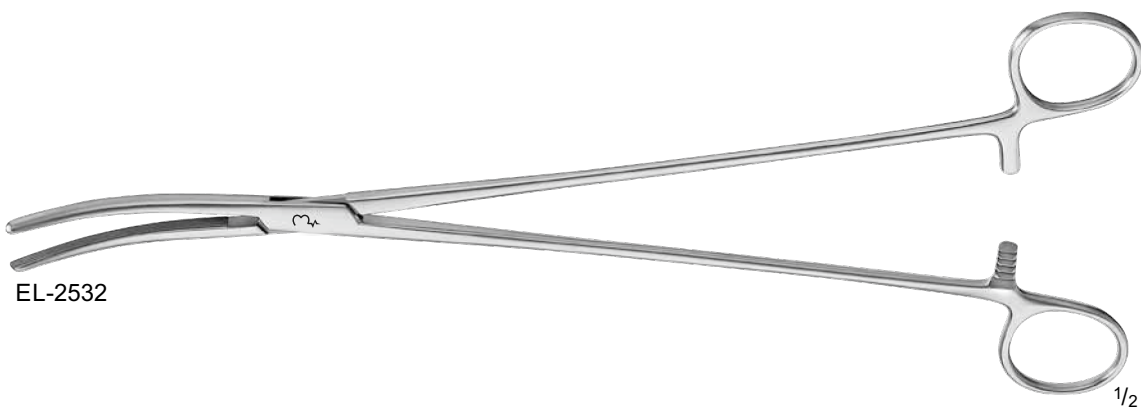

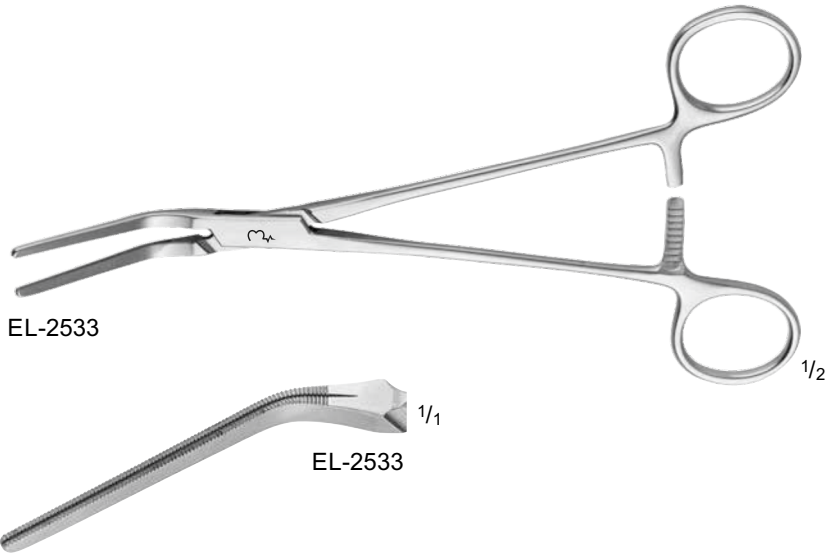

EL-2533

EL-2533

COOLEY Bronchus Clamp

Catalog Number	Jaw	Length (in.)
EL-2533	ANG	8 1/4

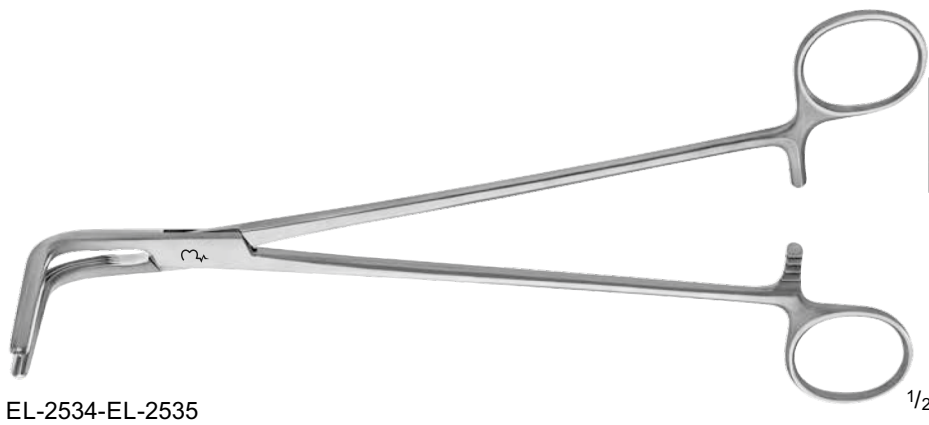

EL-2534-EL-2535

Bronchus Clamp, Longitudinal Serrations

Catalog Number	Jaw Angle	Jaw Length (mm)	Length (in.)
EL-2534	90°	60	9
EL-2535	90°	80	9



EL-2534



EL-2535



INCHES

Cardiovascular Forceps and Clamps

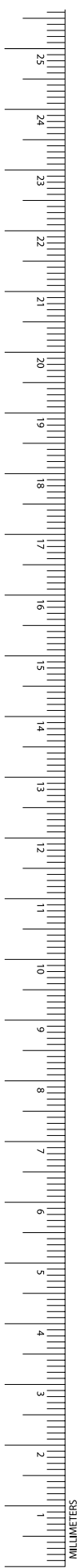

SAROT Bronchus Clamp

Catalog Number	Jaw	Length (in.)
EL-2536	CVD-RIGHT	9
EL-2537	CVD-LEFT	9



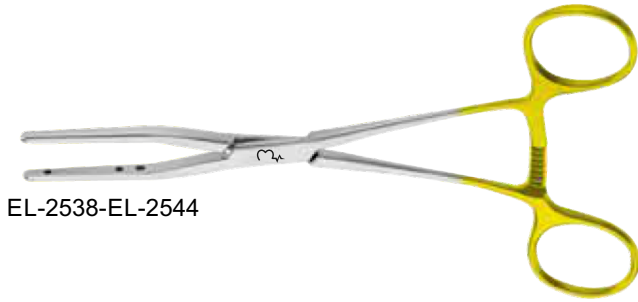

EL-2538-EL-2544

FOGARTY-Type Clamp

Catalog Number	Jaw	Jaw Length (mm)	Length (in.)
EL-2538	STR	33	6 1/2
EL-2539	STR	61	11 5/8
EL-2540	STR	86	12 1/4
EL-2541	ANG	33	4 5/8
EL-2542	ANG	61	8 1/2
EL-2543	ANG	61	8 3/4
EL-2544	ANG	86	9 1/4



EL-2538



EL-2539



EL-2540



EL-2541



EL-2542



EL-2543



EL-2544



EL-2545



EL-2545

FOGARTY-Type Spring Clip Applicator

Catalog Number	Teeth	Length (in.)
EL-2545	1 x 2	7 1/4

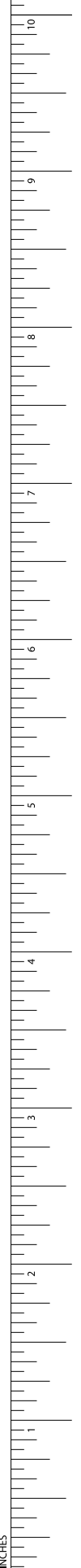

**Cardiovascular
Vascular Clamps**

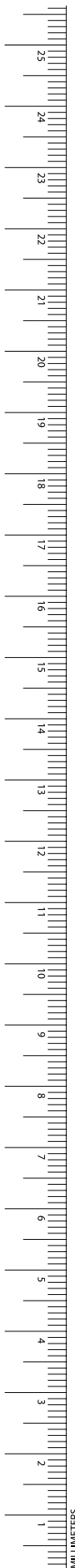

EL-2546

PRICE-THOMAS Bronchus Forceps

Catalog Number	Length (in.)
EL-2546	8 7/8

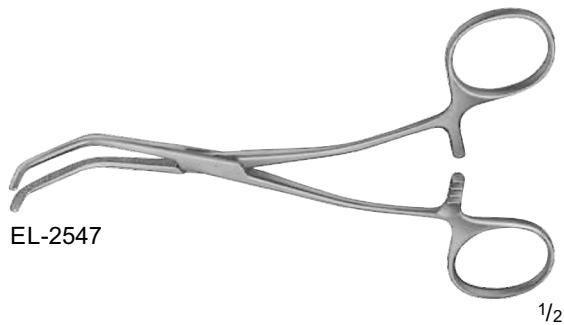

EL-2547

Baby SATINSKY Vena Cava Clamp

Catalog Number	Jaw	Length (in.)
EL-2547	X-SERR	6

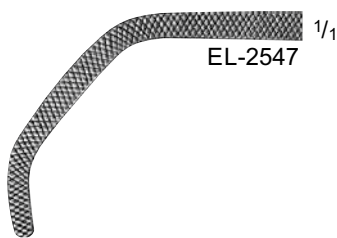

SATINSKY Vena Cava Clamp

Catalog Number	Jaw	Jaw Size	Shaft	Length (in.)
EL-2548	ANG, X-SERR	LARGE	STR	10 1/2
EL-2549	ANG, X-SERR	SMALL	LIGHT-CVD	10 1/2
EL-2550	ANG, X-SERR	LARGE	LIGHT-CVD	10 1/2

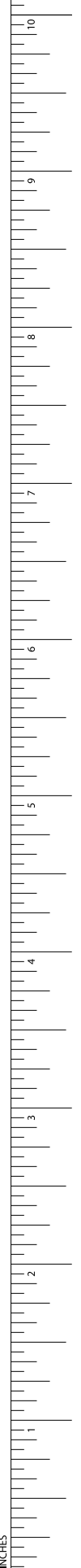
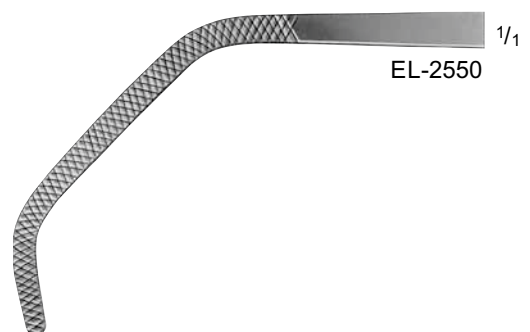
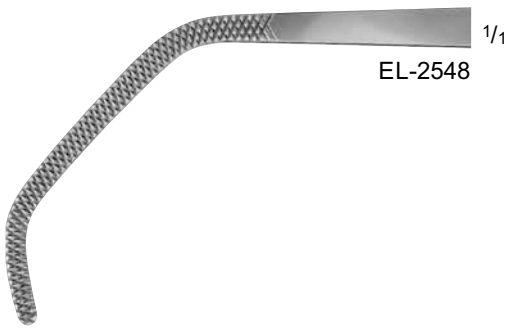

Cardiovascular
Vascular Clamps

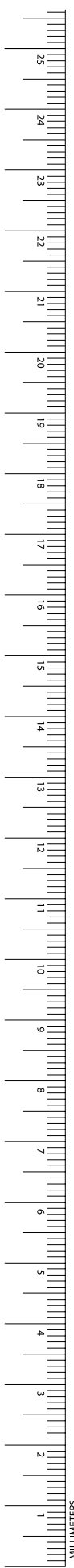

EL-2551

CRAFOORD-SELLORS Coarctation Clamp, Longitudinal Serrations

Catalog Number	Jaw	Length (in.)
EL-2551	SLIGHT-CVD	9 1/2



EL-2551



EL-2552-EL-2553

CRAFOORD Auricle Clamp, Longitudinal Serrations

Catalog Number	Jaw	Length (in.)
EL-2552	MEDIUM-CVD	9 1/2
EL-2553	HEAVY-CVD	9 1/2

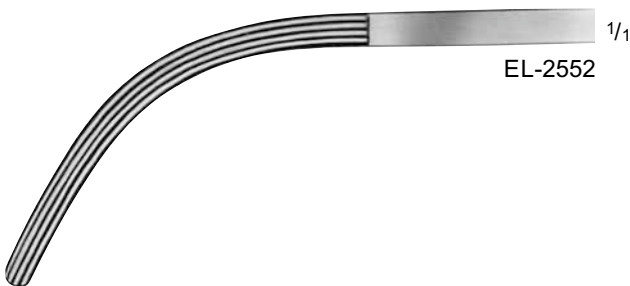

EL-2552



EL-2553

SEMB Suture Forceps

Catalog Number	Jaw	Length (in.)
EL-2554	HEAVY-CVD	9 1/2

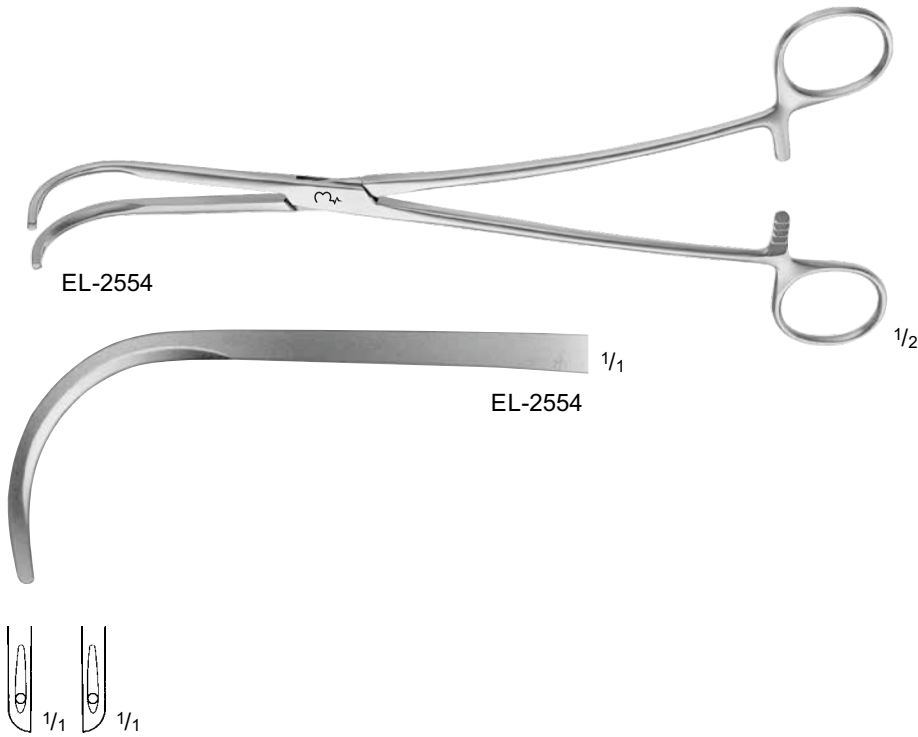

HALLMAN Tunnelling Forceps

Catalog Number	Jaw	Length (in.)
EL-2555	SERR RING	13 1/2

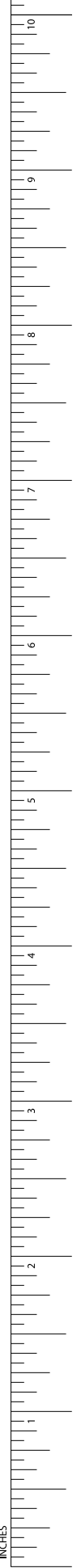
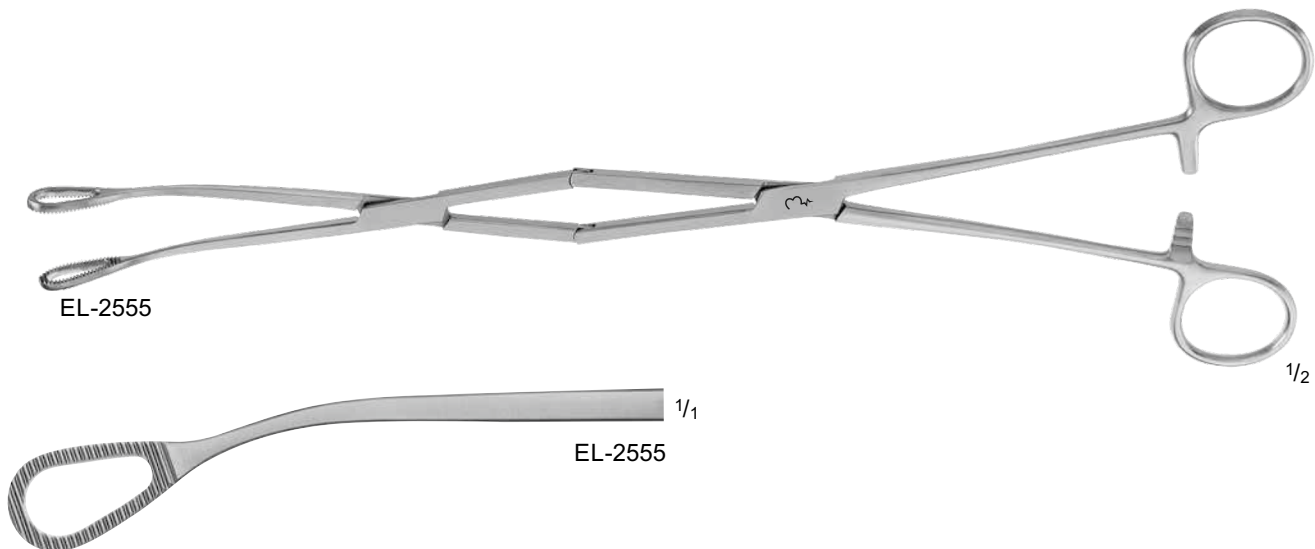

Cardiovascular Vascular Clamps

DEBAKEY Mosquito Atraumatic Forceps

Catalog Number	Jaw	Jaw Length (mm)	Length (in.)
EL-2556	STR	20	5
EL-2557	STR	27	6 1/2
EL-2558	CVD	20	5
EL-2559	CVD	27	6 1/2



EL-2556-EL-2558

1/2



EL-2556

1/1



EL-2558

1/1

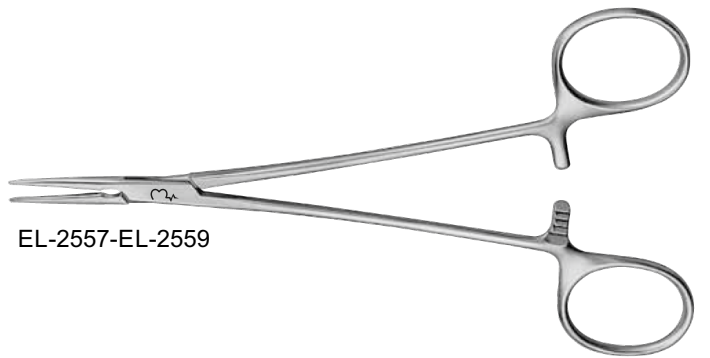

EL-2557-EL-2559

1/2



EL-2557

1/1



EL-2559

1/1

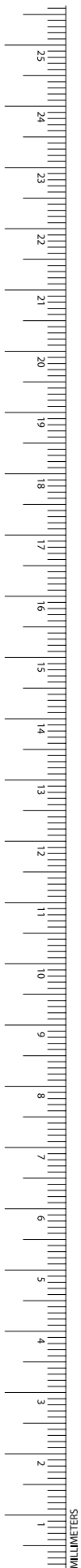



EL-2560-EL-2562



EL-2560



EL-2562



EL-2561-EL-2563



EL-2561



EL-2563

DEBAKEY-BAINBRIDGE Atraumatic Forceps

Catalog Number	Jaw	Jaw Length (mm)	Length (in.)
EL-2560	STR	40	6 1/8
EL-2561	STR	65	7
EL-2562	CVD	40	6 1/8
EL-2563	CVD	65	7



Cardiovascular
Vascular Clamps

**DEBAKEY-HARKEN Atraumatic
Vascular Clamps**

Catalog Number	Tip Size (#)	Jaw	Jaw Length (mm)	Length (in.)
EL-2564	1	CVD	86	10
EL-2565	2	CVD	86	9 5/8
EL-2566	3	CVD	86	9 5/8
EL-2567	4	CVD	86	9 3/4

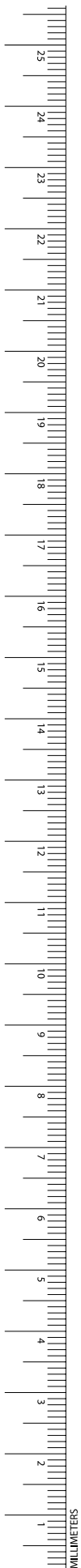
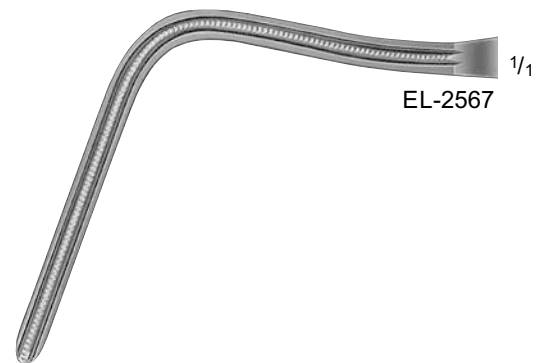
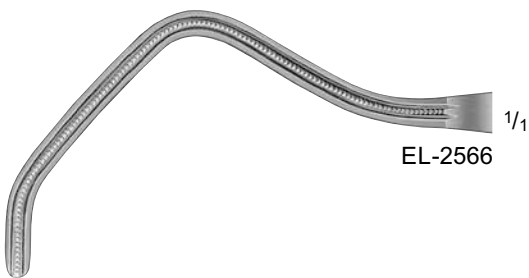
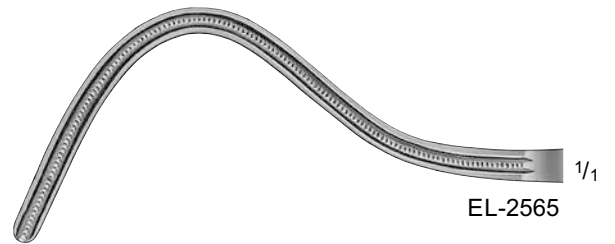

DEBAKEY-PEAN Atraumatic Forceps

Catalog Number	Jaw	Jaw Length (mm)	Length (in.)
EL-2568	STR	60	7 7/8
EL-2569	STR	89	10 1/2
EL-2570	STR	99	11
EL-2571	CVD	60	7 7/8
EL-2572	CVD	89	10 1/4
EL-2573	CVD	99	10 3/4



EL-2568-EL-2573



EL-2568



EL-2569



EL-2570



EL-2571

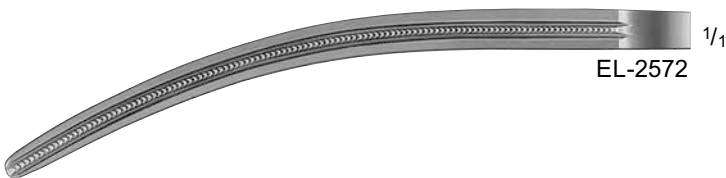

EL-2572

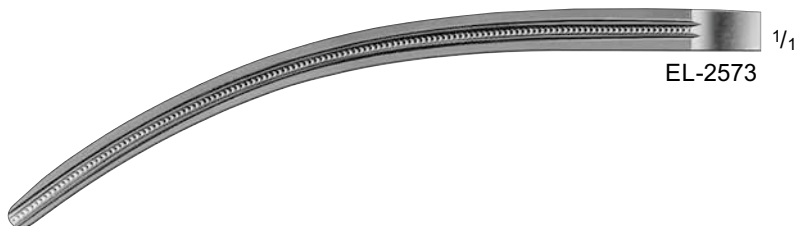

EL-2573

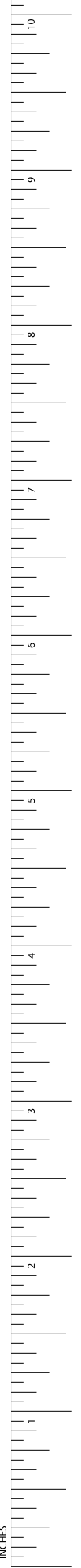

Cardiovascular Vascular Clamps



EL-2574-EL-2578

DEBAKEY Atraumatic Ring Handle Bulldog Clamp

Catalog Number	Jaw Angle	Jaw Length (mm)	Length (in.)
EL-2574	STR	53	5 1/8
EL-2575	CVD	53	5
EL-2576	CVD*	53	5
EL-2577	45°	53	5
EL-2578	90°	53	4 1/8

*Instrument is S-Shaped

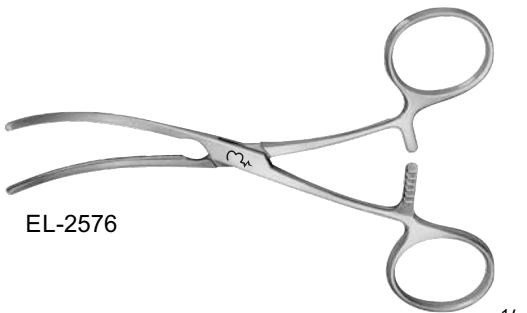
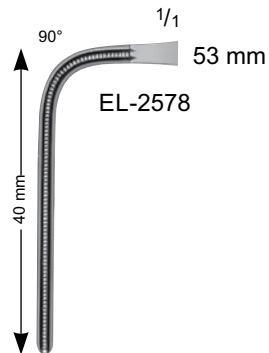
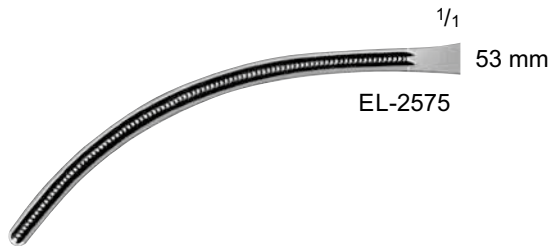
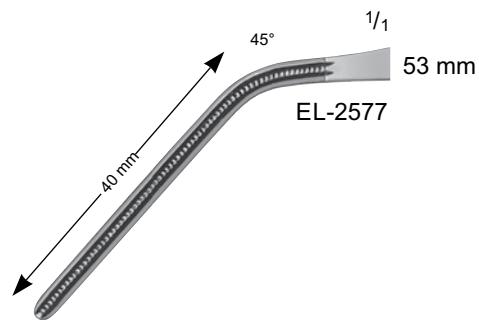

EL-2576

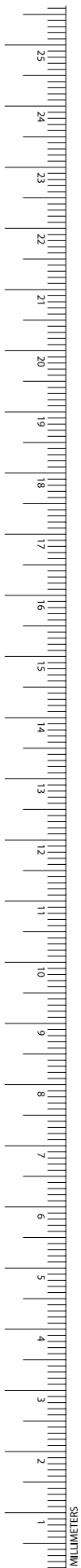
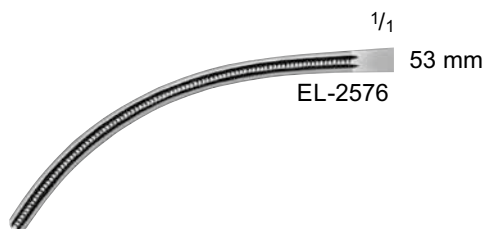

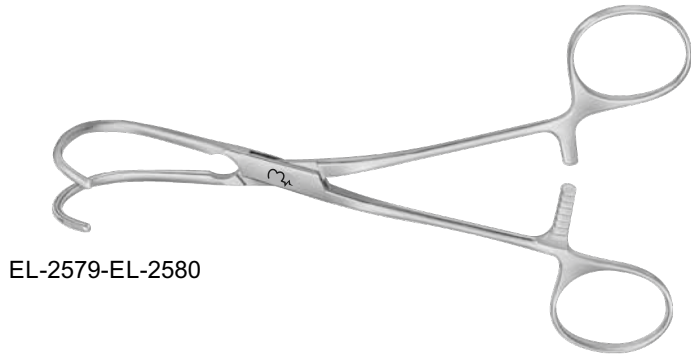

EL-2579-EL-2580

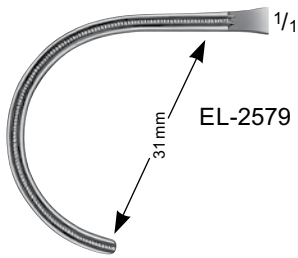

EL-2579

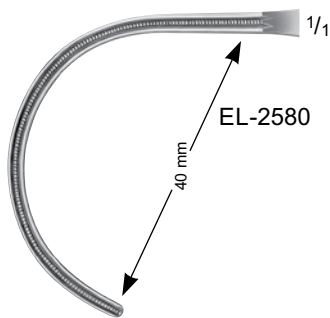

EL-2580

DEBAKEY Atraumatic Multi-Purpose Clamp, Curved

Catalog Number	Jaw Length (mm)	Length (in.)
EL-2579	31	6 1/2
EL-2580	40	6 3/4

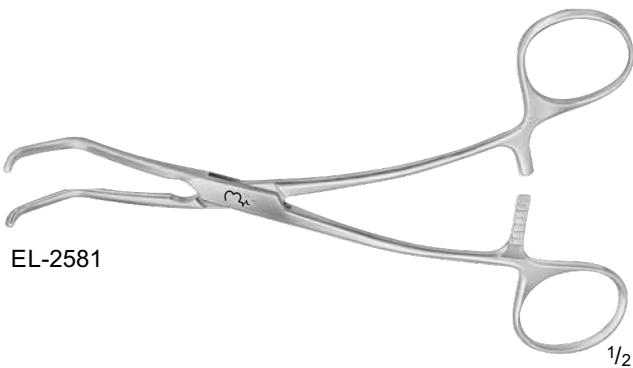

EL-2581

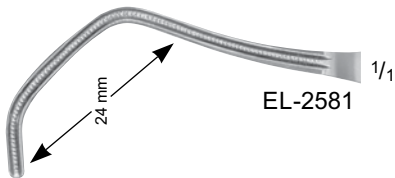

EL-2581

COOLEY Atraumatic Pediatric Vascular Clamp

Catalog Number	Jaw Angle	Jaw Length (mm)	Length (in.)
EL-2581	MULTI	24	6 1/4

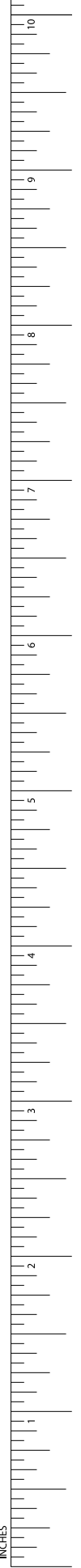

Cardiovascular

Vascular Clamps

COOLEY Atraumatic Pediatric Vascular Clamp (continued)

Catalog Number	Jaw Angle	Jaw Length (mm)	Length (in.)
EL-2582	25°	38	5 3/4
EL-2583	30°	30	6 1/2
EL-2584	60°	30	6 1/4
EL-2585	90°	30	6
EL-2586	MULTI	90	7 7/8

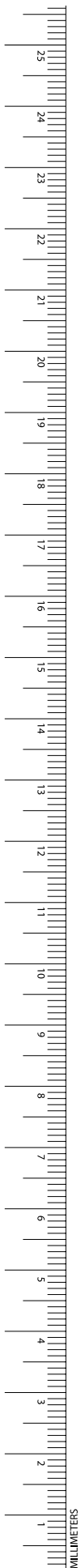
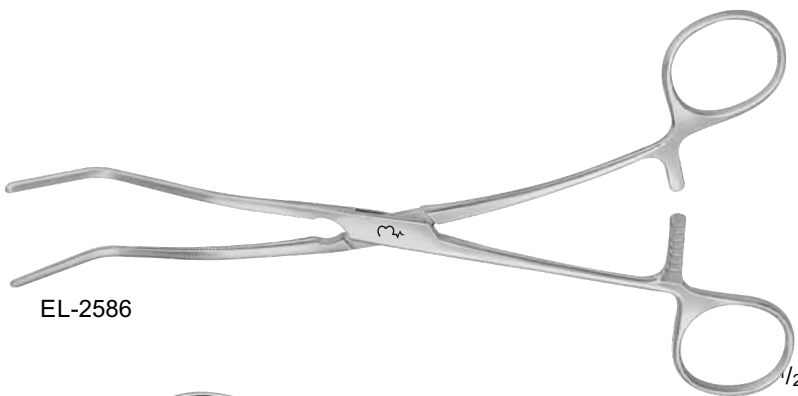
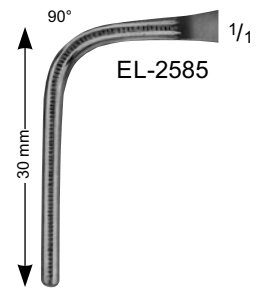
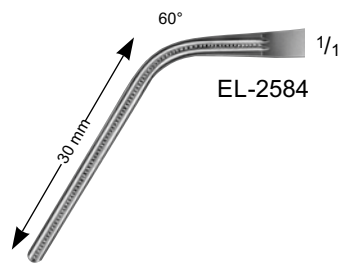
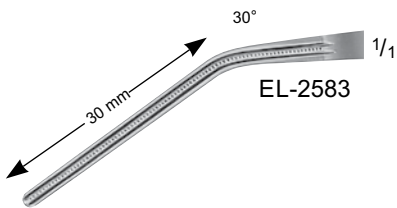
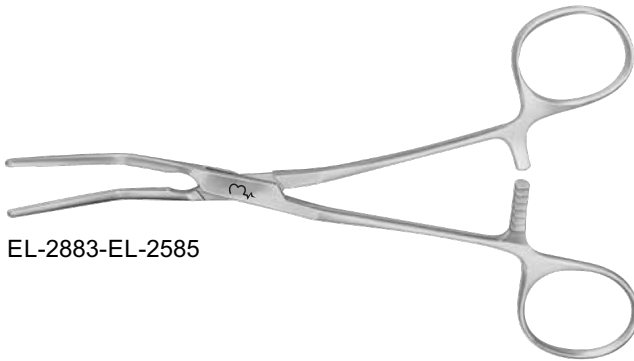
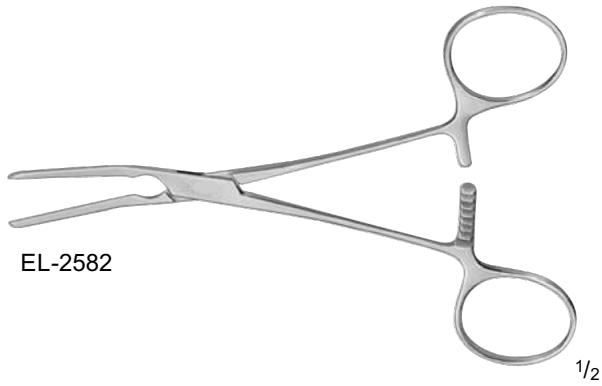



EL-2587-EL-2588

1/2

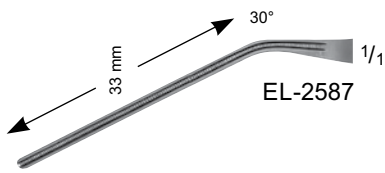

EL-2587

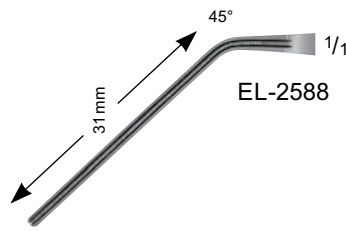

EL-2588

CASTANEDA Atraumatic Neonatal Clamp, Angled

Catalog Number	Jaw Angle	Jaw Length (mm)	Length (in.)
EL-2587	30°	33	4 3/4
EL-2588	45°	31	4 3/4



EL-2589-EL-2592

1/2

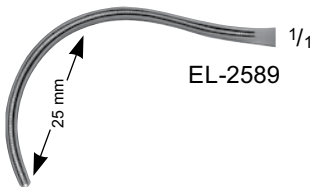

EL-2589

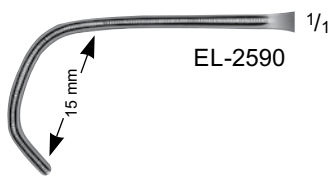

EL-2590

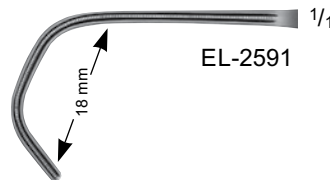

EL-2591

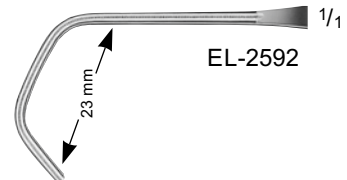

EL-2592

CASTANEDA Atraumatic Neonatal Clamp

Catalog Number	Jaw Angle	Jaw Length (mm)	Length (in.)
EL-2589	CVD	15	6 1/8
EL-2590	MULTI	18	6 1/8
EL-2591	MULTI	23	6 1/8
EL-2592	MULTI	25	6 1/8

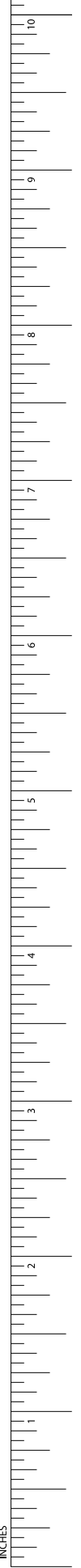

Cardiovascular Vascular Clamps

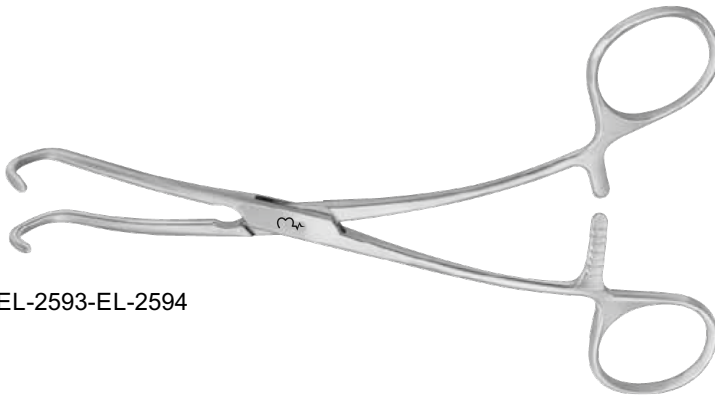
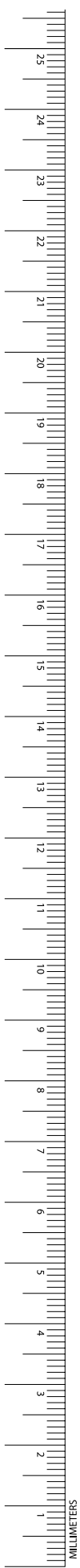

EL-2593-EL-2594

DERRA Atraumatic Pediatric Forceps

Catalog Number	Jaw Angle	Jaw Length (mm)	Length (in.)
EL-2593	MULTI	16	6 3/4
EL-2594	MULTI	20	6 3/4
EL-2595	MULTI	26	6 7/8

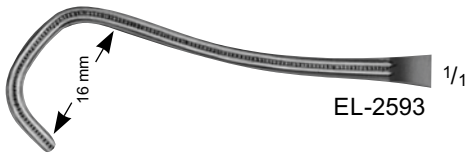

EL-2593



EL-2594

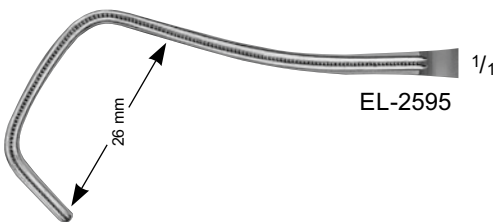

EL-2595



LELAND-JONES Atraumatic Peripheral Clamp

Catalog Number	Jaw Angle	Jaw Length (mm)	Length (in.)
EL-2596	STR	77	7 3/4
EL-2597	15°	65	7 1/2
EL-2598	30°	65	7 1/2

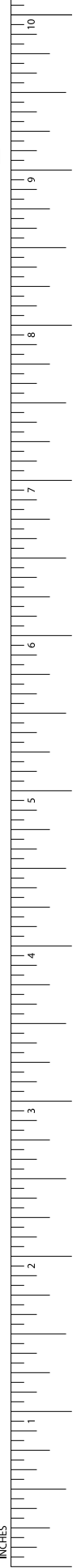
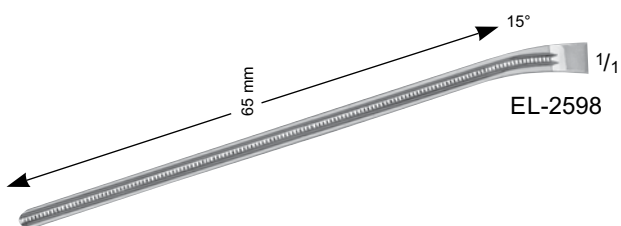
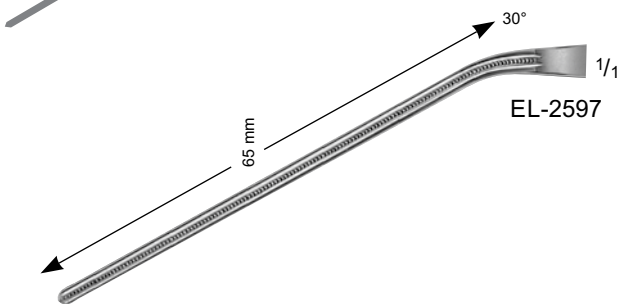

Cardiovascular

Vascular Clamps

DEBAKEY Atraumatic Suture Forceps

Catalog Number	Jaw	Jaw Length (mm)	Shaft	Length (in.)
EL-2599	CVD	94	CVD	9 1/2

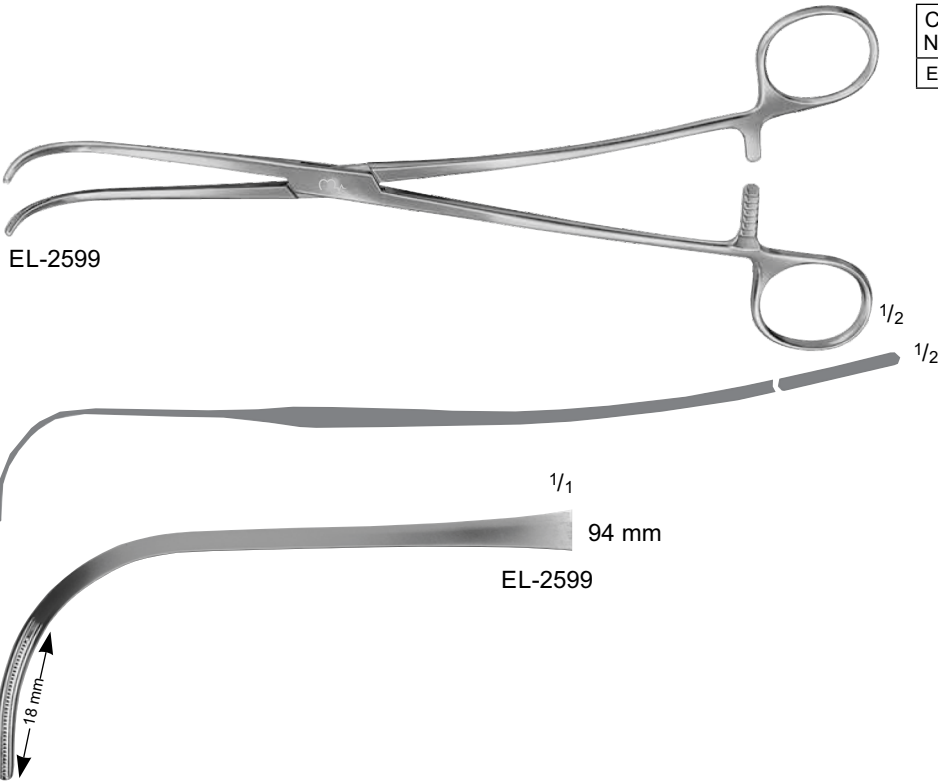

DIETRICH Atraumatic Aortic Clamp

Catalog Number	Jaw Angle	Jaw Length (mm)	Length (in.)
EL-2600	MULTI	45	8 1/4

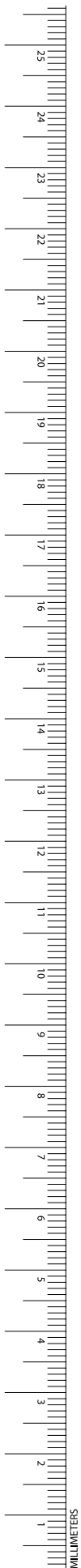
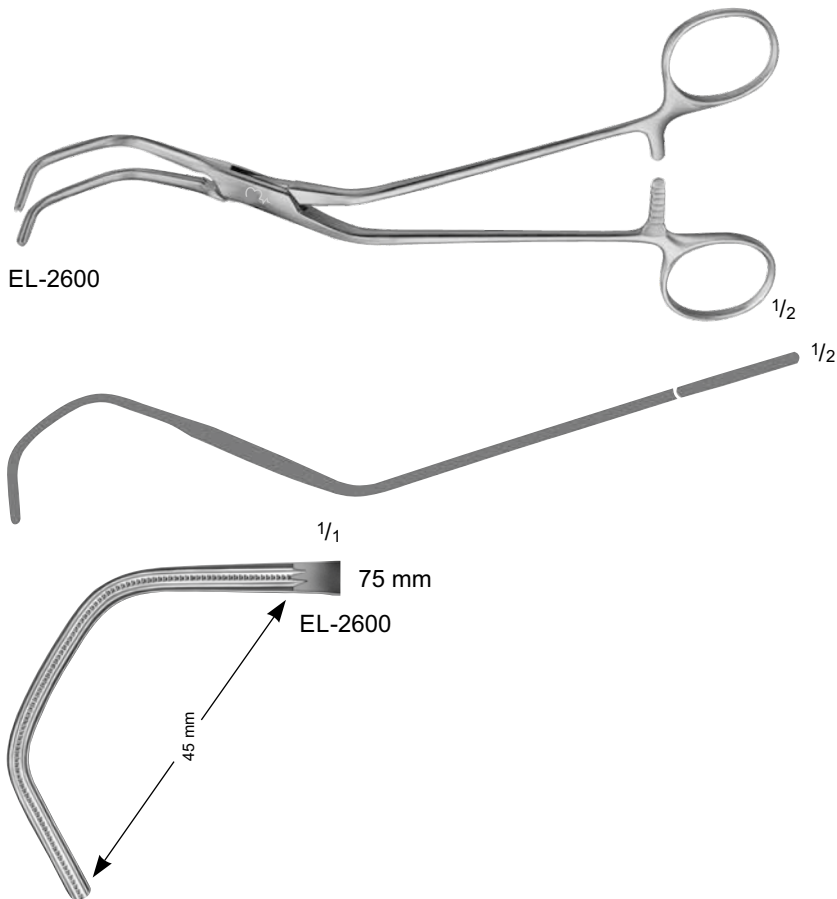

DEBAKEY Atraumatic Forceps

Catalog Number	Jaw	Jaw Length (mm)	Length (in.)
EL-2601	C-CURVE	77	7 1/2
EL-2602	C-CURVE	51	8 1/4
EL-2603	D-CURVE	80	9
EL-2604	D-CURVE	75	9

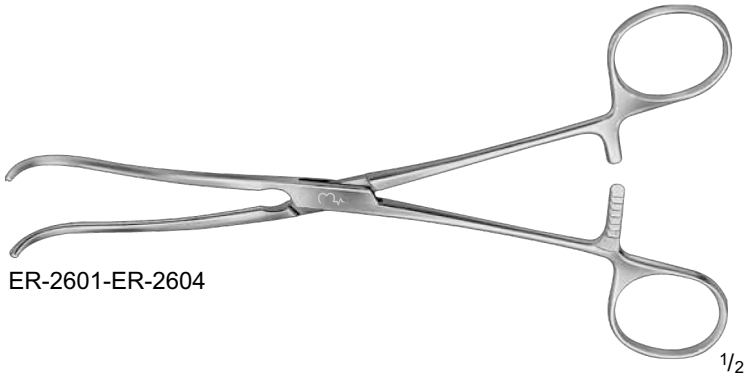

HENLY Atraumatic Clamp

Catalog Number	Jaw Length (mm)	Length (in.)
EL-2605	75	7 7/8

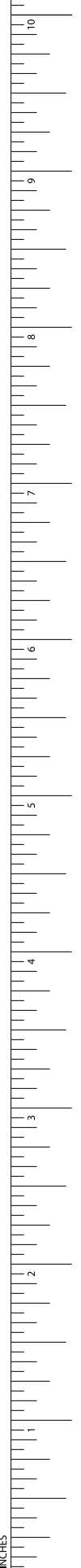
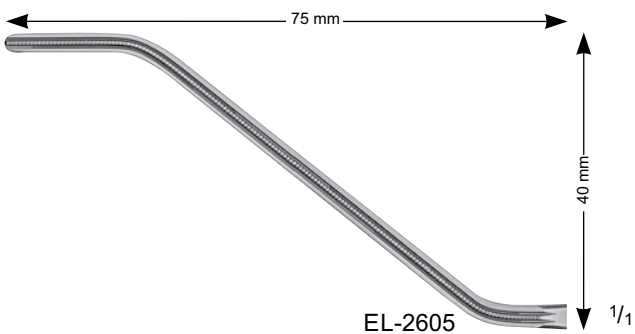

Cardiovascular
Vascular Clamps

DEBAKEY-RUMEL Atraumatic Forceps

Catalog Number	Jaw	Jaw Length (mm)	Length (in.)
EL-2606	SIGHT-CVD	81	9 3/4
EL-2607	CVD	81	9 5/8

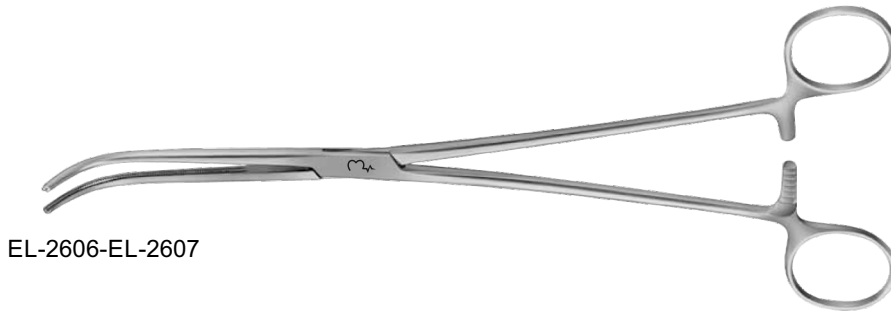

EL-2606-EL-2607



EL-2606



EL-2607

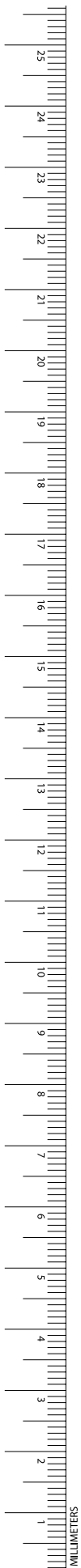

LEES Atraumatic Bronchus Clamp

Catalog Number	Jaw Angle	Jaw Length (mm)	Length (in.)
EL-2608	90°	42	8 3/4

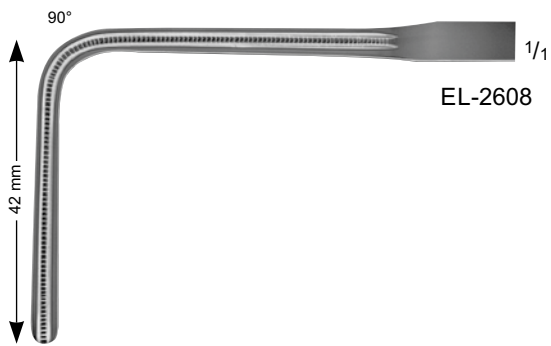

LEES Atraumatic Bronchus Clamp

Catalog Number	Jaw Angle	Jaw Length (mm)	Shaft	Length (in.)
EL-2609	ANG	40	CVD	9 5/8

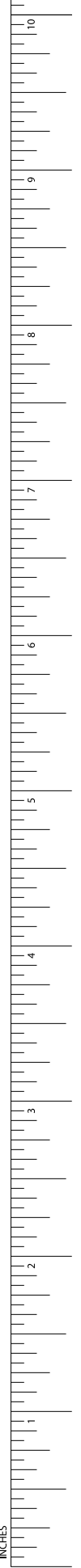
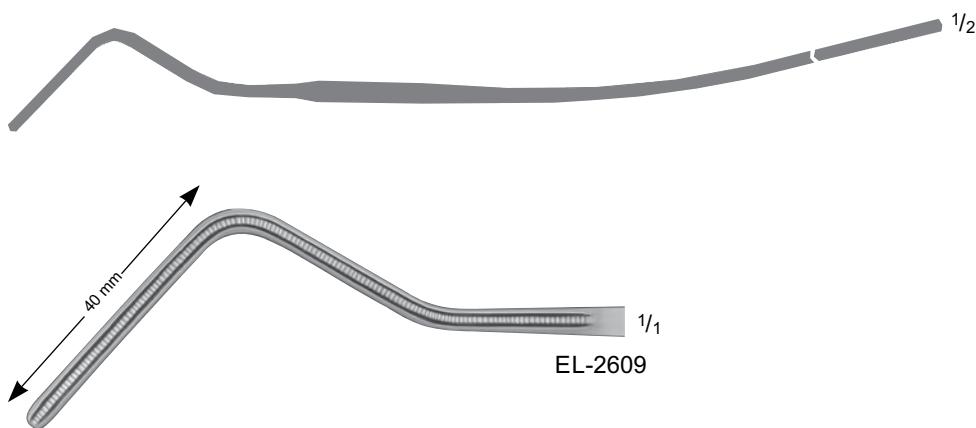

Cardiovascular Vascular Clamps

DEBAKEY Atraumatic Multi-Purpose Clamp

Catalog Number	Jaw Angle	Jaw Length (mm)	Length (in.)
EL-2610	60°	40	9 1/2
EL-2611	60°	55	8 3/4
EL-2612	60°	65	11
EL-2613	60°	100	12



EL-2610-EL-2611

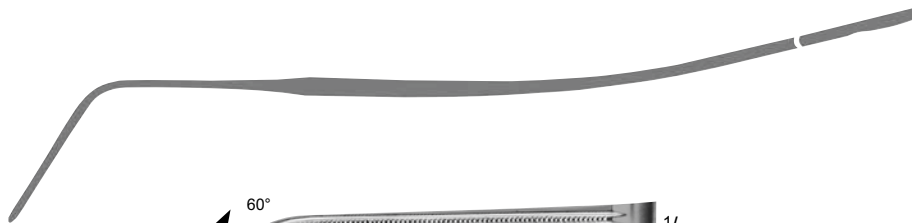

EL-2610

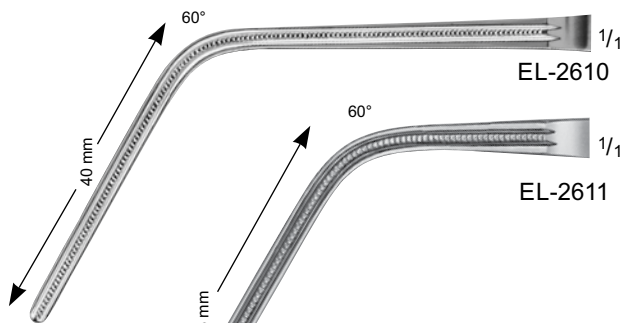

EL-2611

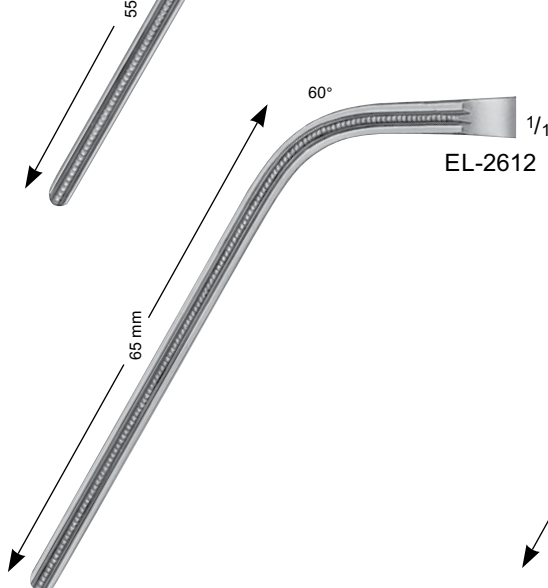

EL-2612

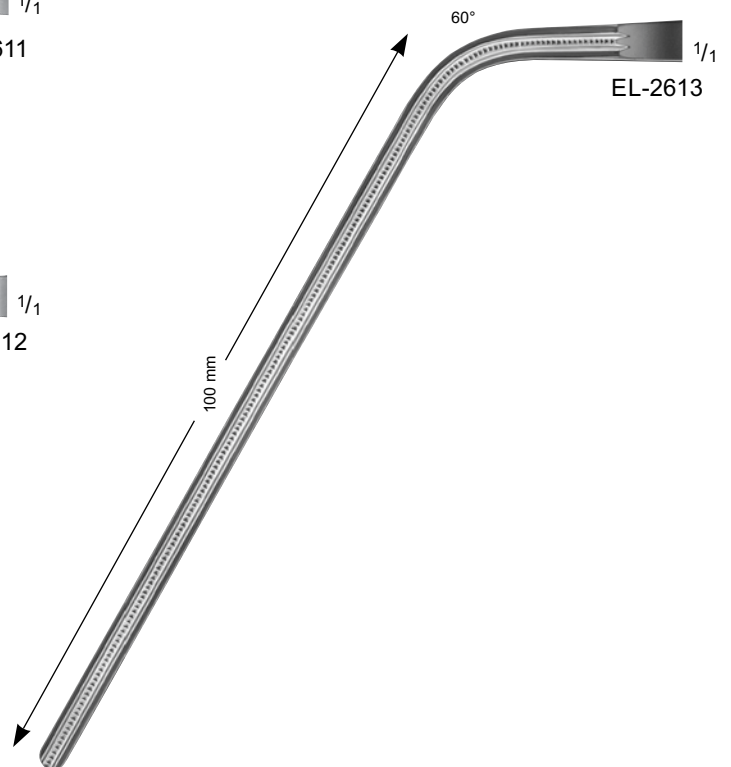

EL-2613

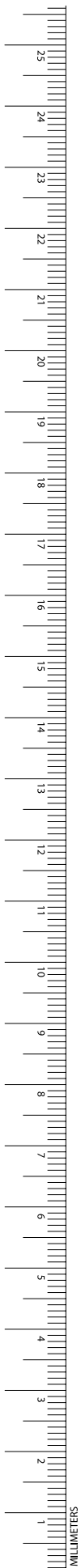

DEBAKEY Atraumatic Multi-Purpose Clamp

Catalog Number	Jaw Angle	Jaw Length (mm)	Length (in.)
EL-2614	90°	45	8 7/8
EL-2615	90°	55	8 1/4
EL-2616	90°	72	10
EL-2617	90°	108	10 3/4

ER-2614-ER-2617

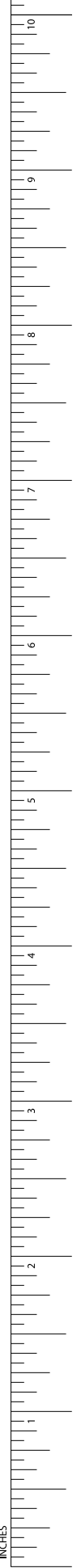
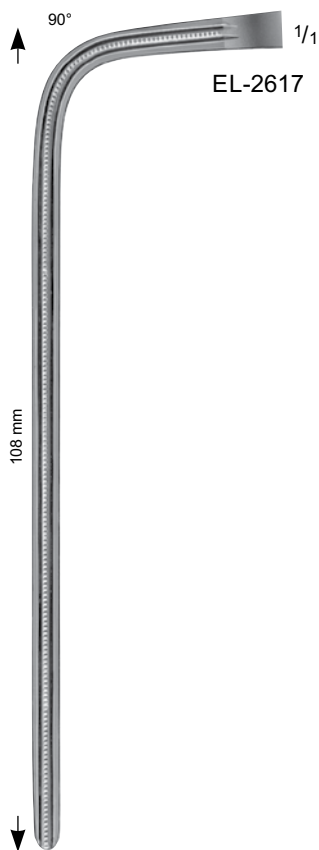
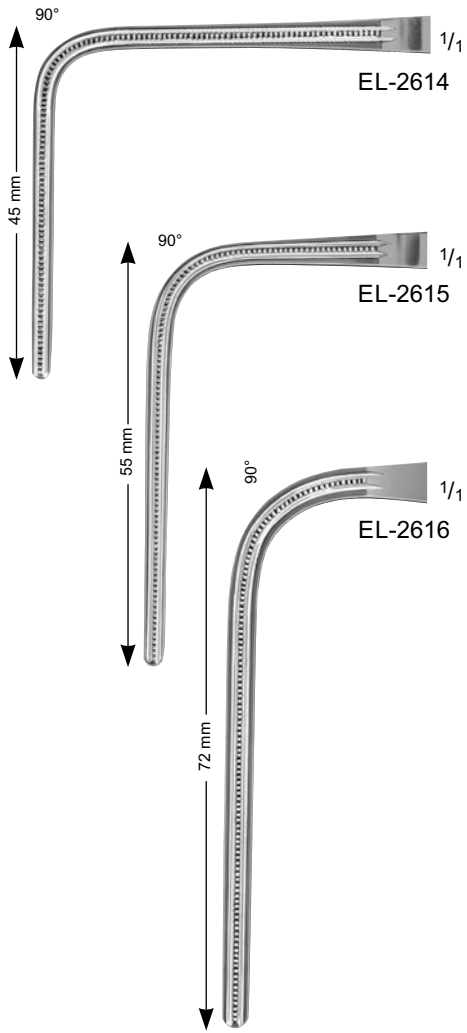
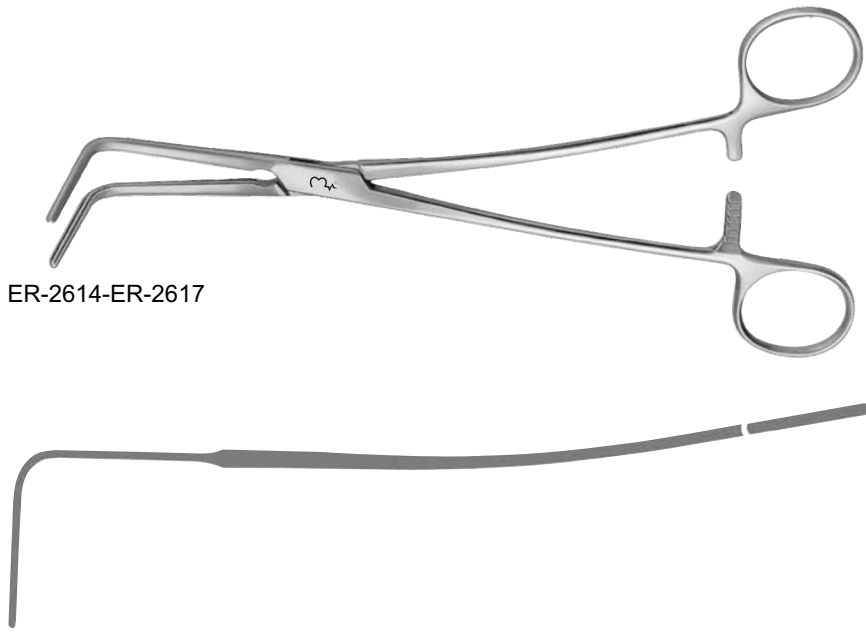

Cardiovascular Vascular Clamps

LEMOLE-STRONG Atraumatic Clamp, Angled Shaft

Catalog Number	Jaw Size (mm)	Length (in.)
EL-2618	40 x 15	7 7/8
EL-2619	45 x 20	7 7/8

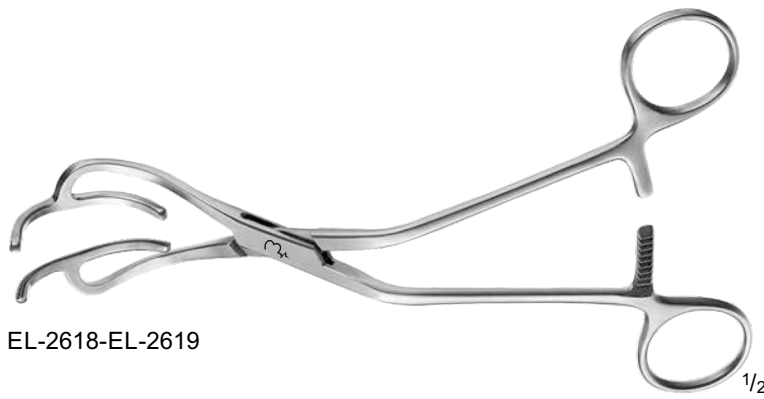

EL-2618-EL-2619

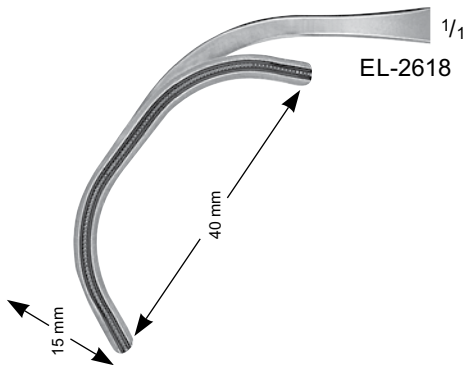

EL-2618

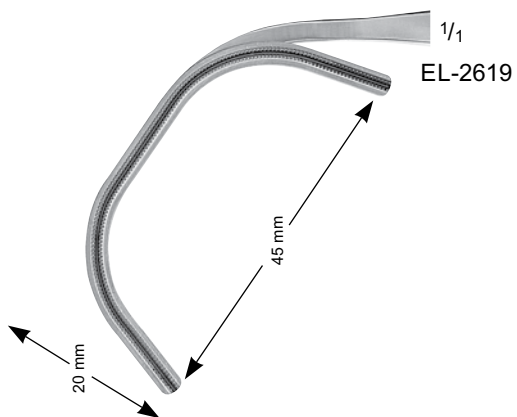

EL-2619

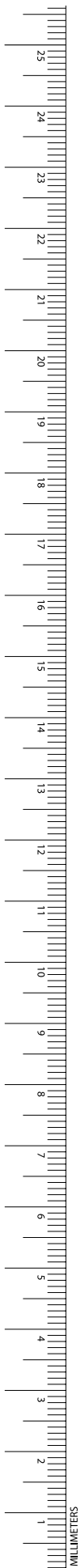

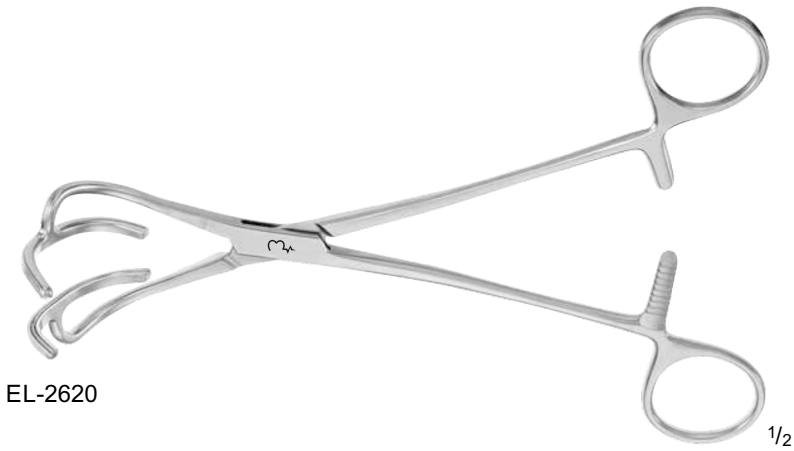

EL-2620

1/2

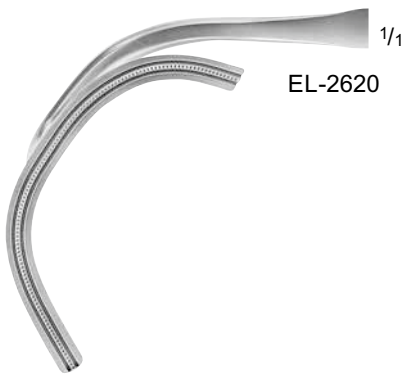

EL-2620

1/1

STRONG Aorta Clamp, Straight Shaft

Catalog Number	Jaw	Length (in.)
EL-2620	CVD	7 7/8

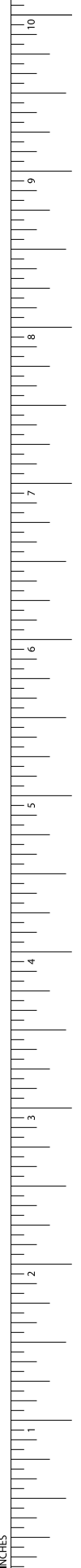

Cardiovascular Vascular Clamps

WYLIE Hypogastric Clamp

Catalog Number	Jaw	Jaw Length (mm)	Shaft	Length (in.)
EL-2621	CVD	70	ANG	8 1/2
EL-2622	CVD	75	ANG	9 3/4



EL-2621-EL-2622

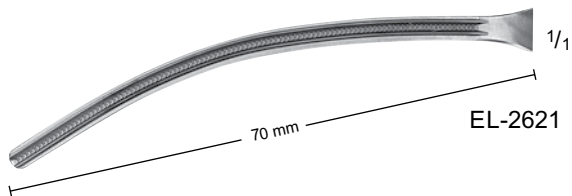

EL-2621

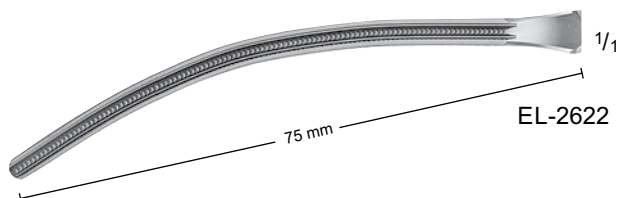

EL-2622

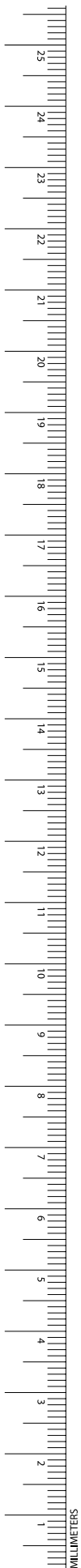

WYLIE Atraumatic Clamp

Catalog Number	Jaw	Length (in.)
EL-2623	HEAVY-CVD	8 3/4
EL-2624	CVD-BACK	9



EL-2623-EL-2624

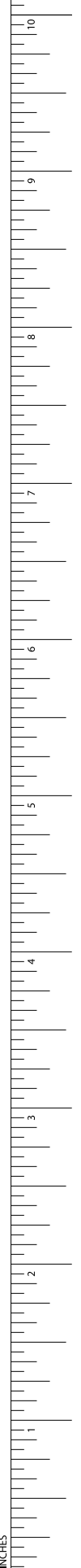
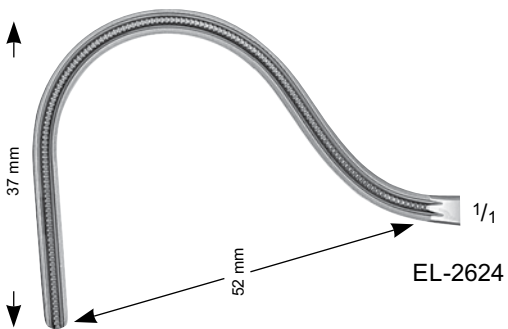
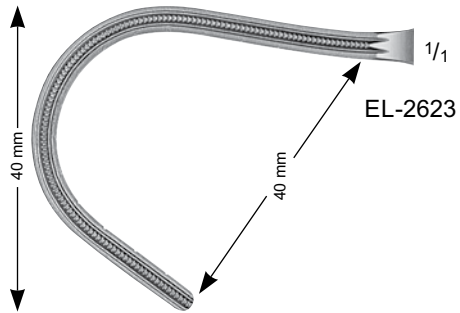

Cardiovascular Vascular Clamps

WYLIE Atraumatic Clamp

Catalog Number	Jaw	Length (in.)
EL-2625	CVD-UP	6 1/4
EL-2626	CVD-UP	7

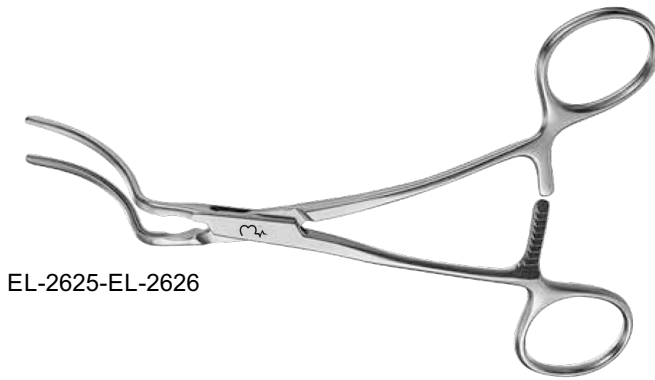

EL-2625-EL-2626

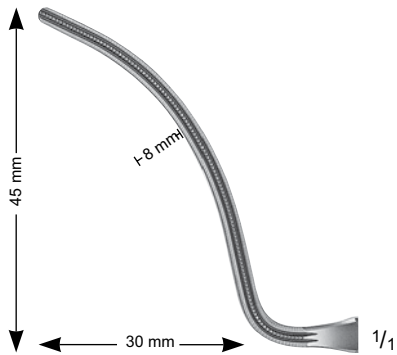

EL-2625

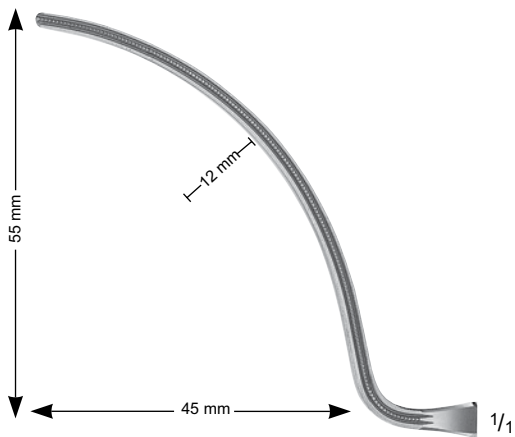

EL-2626

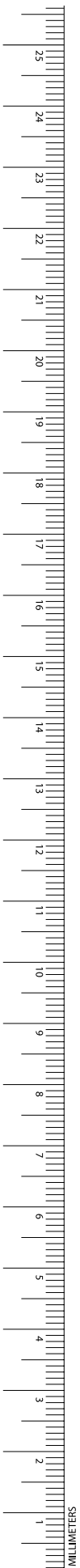

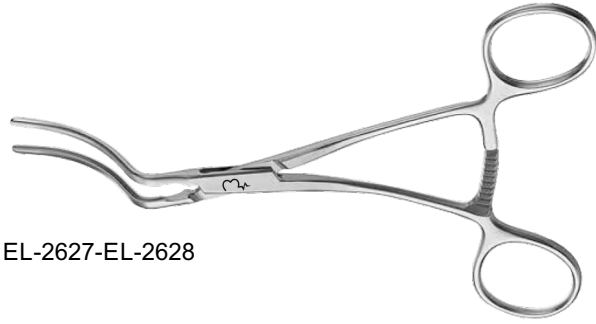

EL-2627-EL-2628

WYLIE Atraumatic Clamp

Catalog Number	Jaw	Length (in.)
EL-2627	CVD-DOWN	6
EL-2628	CVD-DOWN	6 1/2

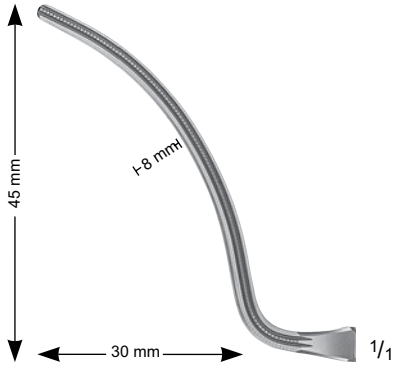

EL-2627

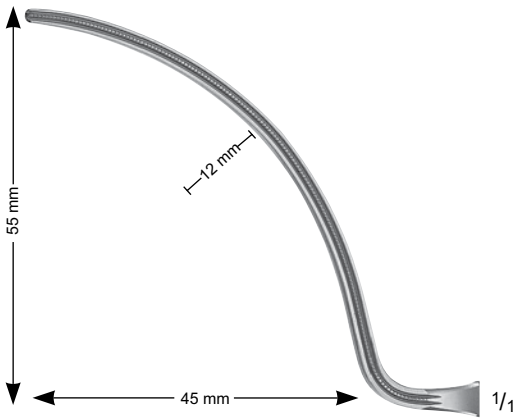

EL-2628

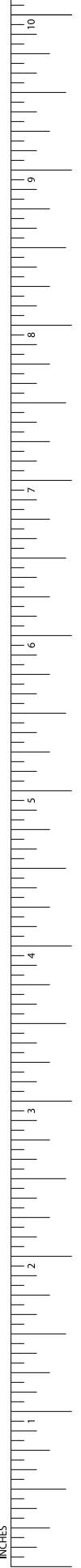

Cardiovascular Vascular Clamps

DEBAKEY Atraumatic Patent Ductus Clamp

Catalog Number	Jaw Length (mm)	Shaft	Length (in.)
EL-2629	51	STR	8 1/4
EL-2630	51	ANG	8 1/4



EL-2629



EL-2630

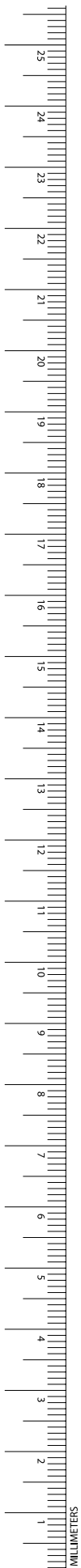
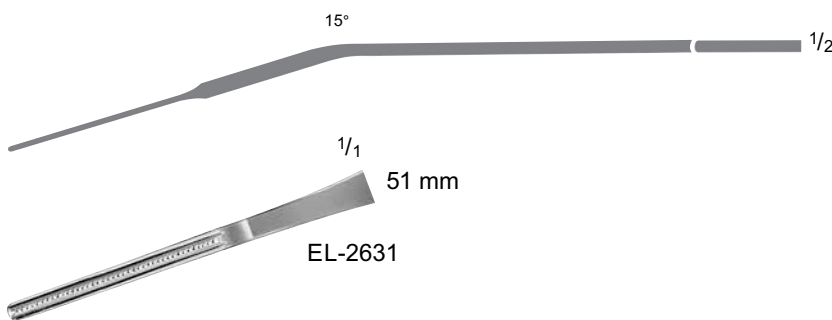



EL-2631-EL-2634

DEBAKEY Atraumatic Coarctation Clamp

Catalog Number	Jaw Length (mm)	Shaft	Length (in.)
EL-2631	41	ANG	7 7/8
EL-2632	50	ANG	6 1/2
EL-2633	65	ANG	8 7/8
EL-2634	80	ANG	9 1/2

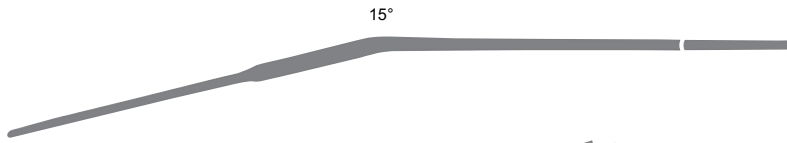

15°



EL-2631



EL-2632



EL-2633

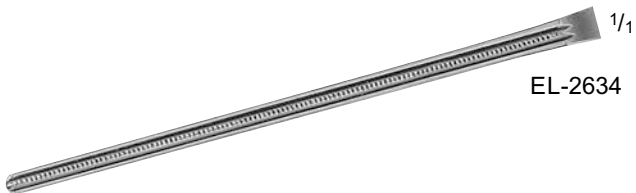

EL-2634

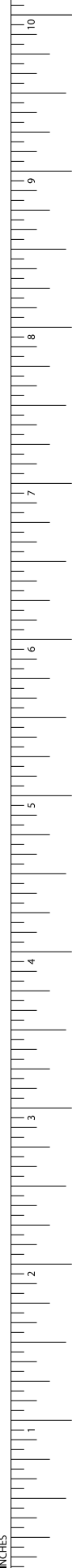

INCHES

Cardiovascular Vascular Clamps



EL-2635-EL-2638



EL-2635



EL-2636



EL-2637



EL-2638



ER-2639



ER-2639

DEBAKEY Atraumatic Coarctation Clamp

Catalog Number	Jaw	Jaw Length (mm)	Length (in.)
EL-2635	STR	41	8
EL-2636	STR	50	6 3/4
EL-2637	STR	65	8 7/8
EL-2638	STR	80	9 1/2

NOON AV Fistula Clamp

Catalog Number	Jaw Angle	Length (in.)
EL-2639	50°	4 3/4

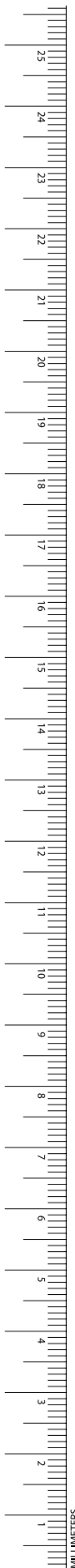



EL-2640-ER2642

GLOVER Atraumatic Clamp

Catalog Number	Jaw	Jaw Length (mm)	Length (in)
EL-2640	CVD	65	8 1/2
EL-2641	SPOON SHAPED	60	8 3/4
EL-2642	SPOON SHAPED	70	9 5/8
EL-2643	CVD	86	9 5/8
EL-2644	FULL-CVD	47	7 3/4
EL-2645	FULL-CVD	63	8 1/4

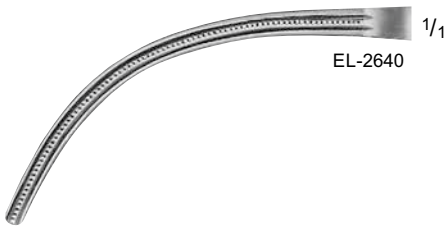

EL-2640

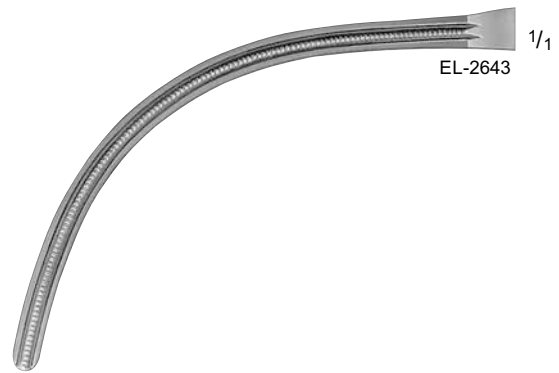

EL-2643



EL-2641

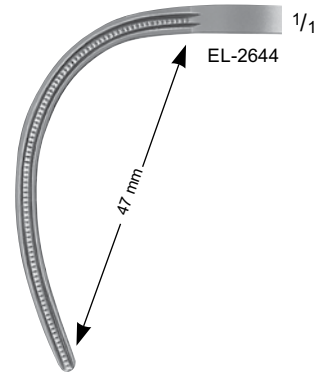

EL-2644



EL-2642

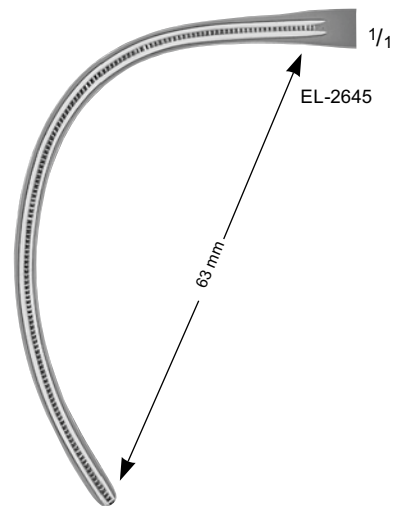

EL-2645

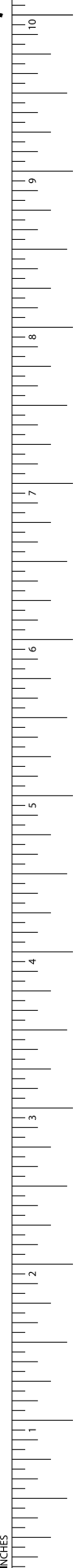

Cardiovascular Vascular Clamps

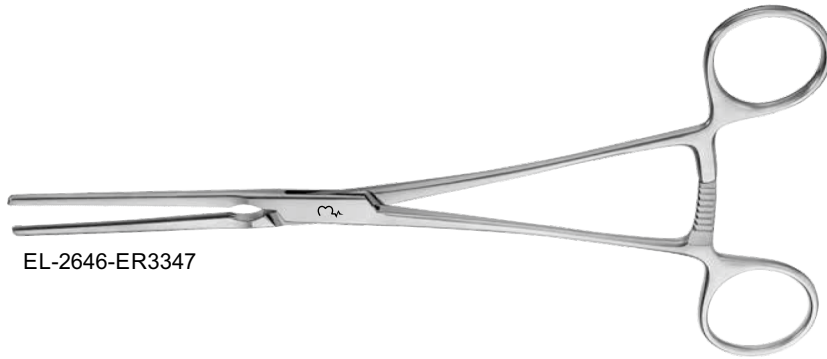
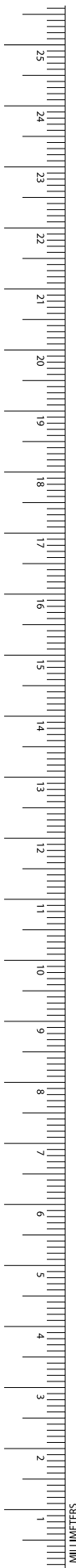

EL-2646-ER3347



EL-2646



EL-2647



EL-2648-EL-2649



EL-2648



EL-2649

GLOVER Coarctation Clamp

Catalog Number	Jaw	Jaw Length (mm)	Length (in.)
EL-2646	STR	60	9
EL-2647	STR	70	10 1/4
EL-2648	ANG	60	8 3/4
EL-2649	ANG	70	10

GREGORY Atraumata Profunda Clamp

Catalog Number	Jaw	Jaw Length (mm)	Length (in.)
EL-2650	X-SMALL	29	5
EL-2651	SMALL	57	5 3/4
EL-2652	MEDIUM	62	7
EL-2653	LARGE	75	7 3/4

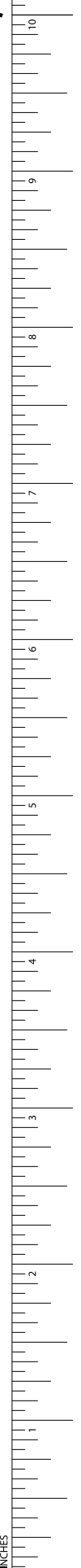
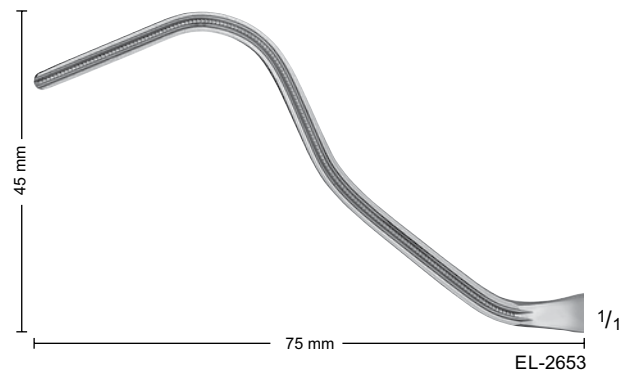
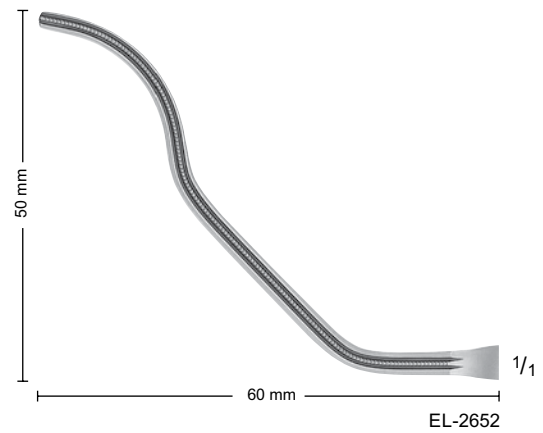
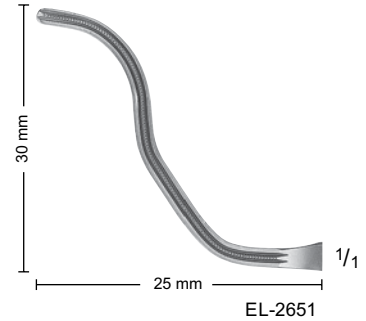
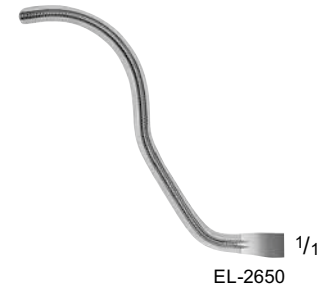
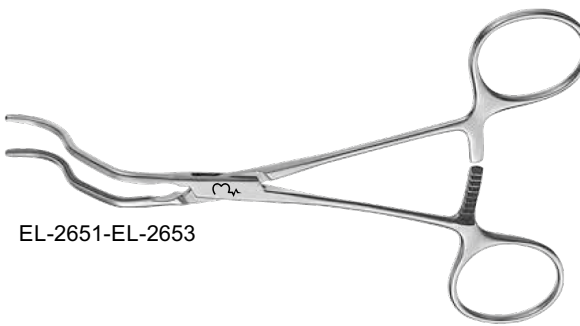
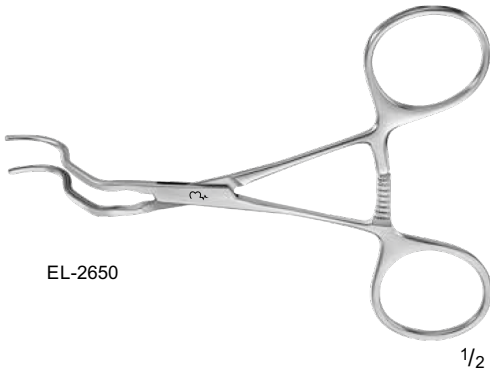

Cardiovascular Vascular Clamps

DALE Femoral Popliteal Clamp

Catalog Number	Jaw	Length (in.)
EL-2654	SMALL	6 7/8
EL-2655	MEDIUM	7
EL-2656	LARGE	7
EL-2657	-	7

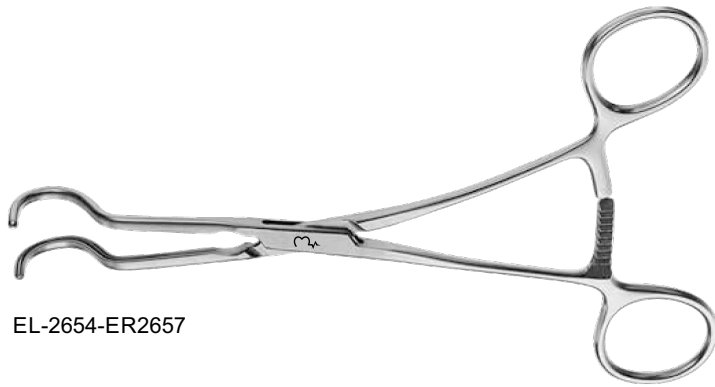

EL-2654-ER2657

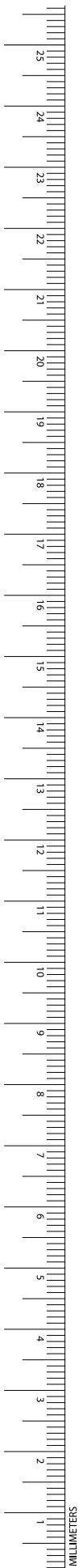
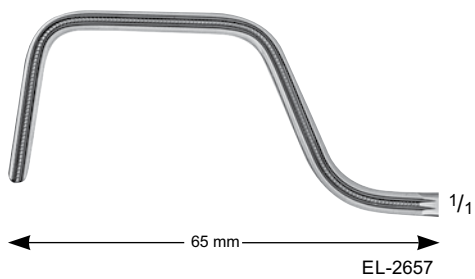
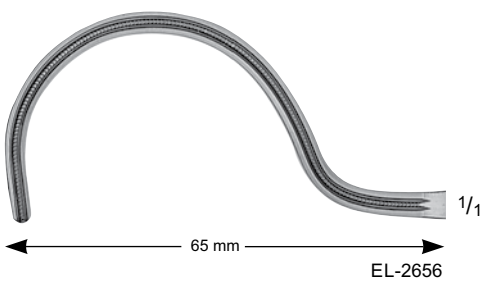
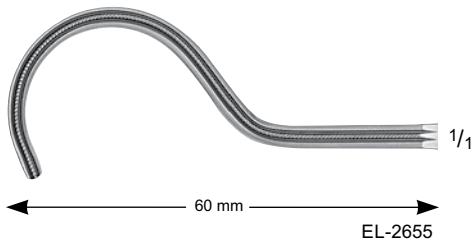
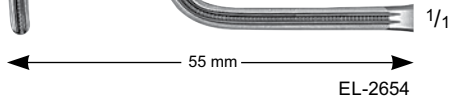

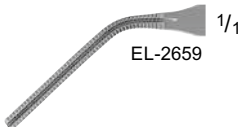
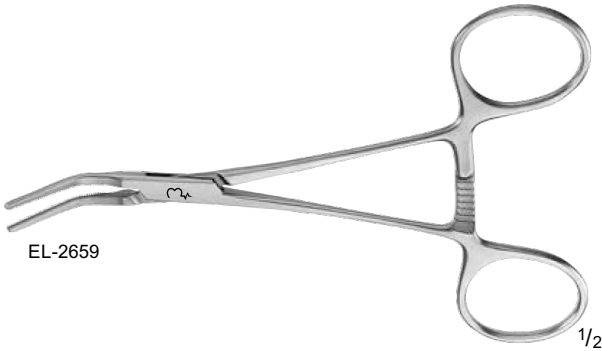
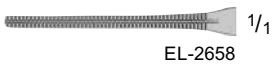

SELMAN Vessel Forceps

Catalog Number	Jaw	Jaw Length (mm)	Length (in.)
EL-2658	STR. COOLEY SERR	25	5 1/4
EL-2659	ANG. COOLEY SERR	25	5 1/4

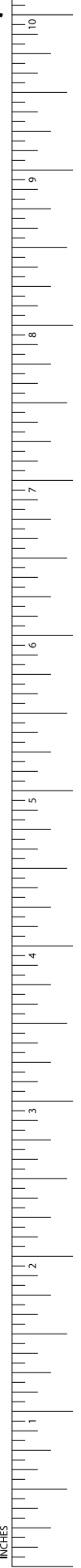

Cardiovascular
Vascular Clamps

CHERRY Clamp

Catalog Number	Jaw	Teeth	Shaft	Length (in.)
EL-2660	CVD	2 x 3	60° ANG	12 3/8

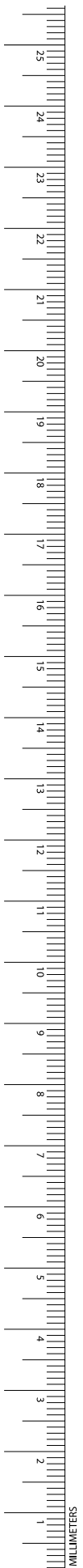

EL-2660

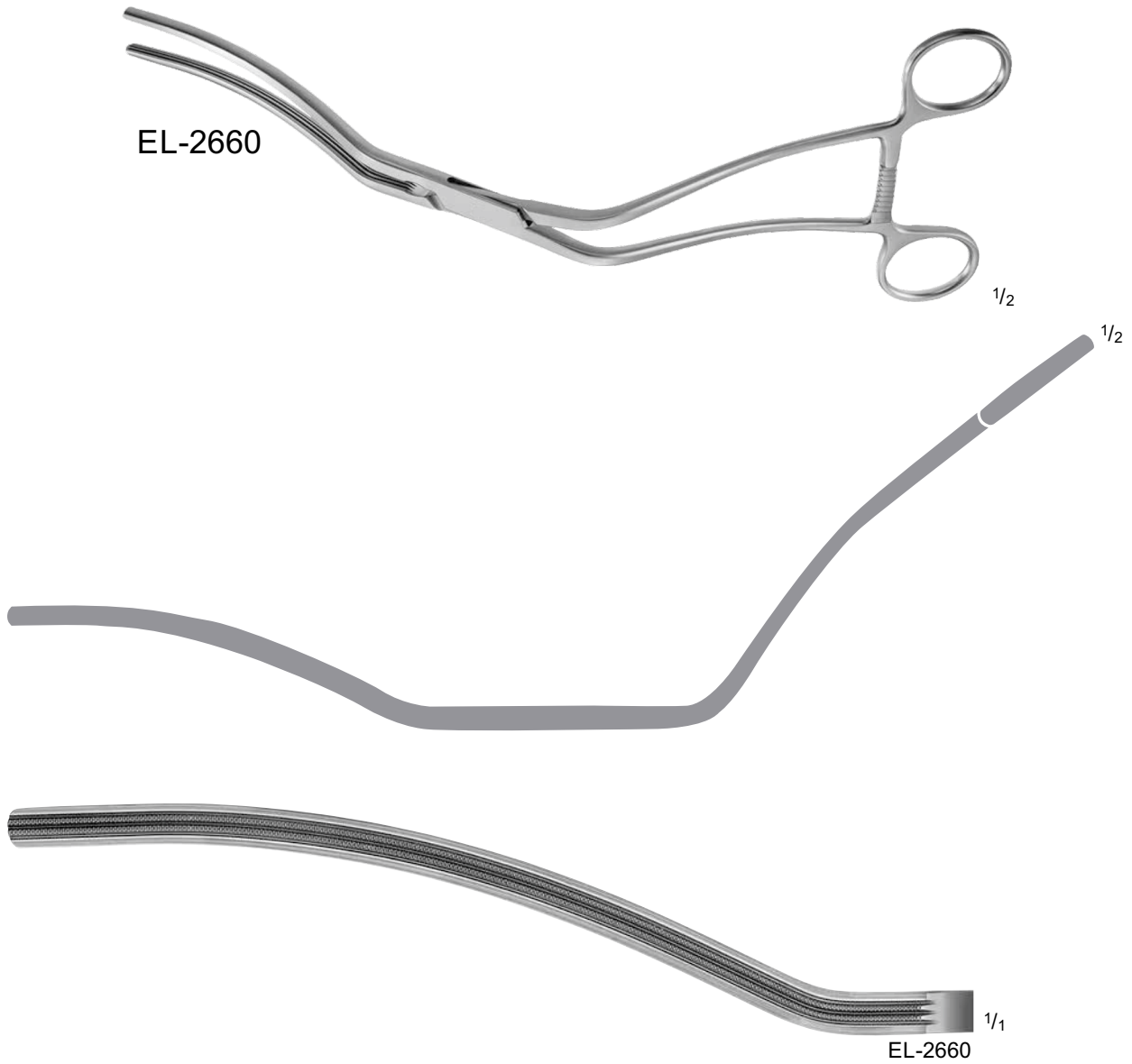

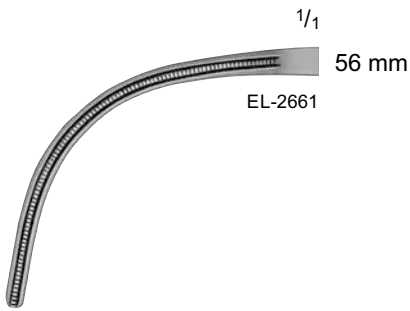

DEBAKEY Atraumatic Peripheral Clamp #1

Catalog Number	Jaw Length (mm)	Length (in.)
EL-2661	56	6 1/4

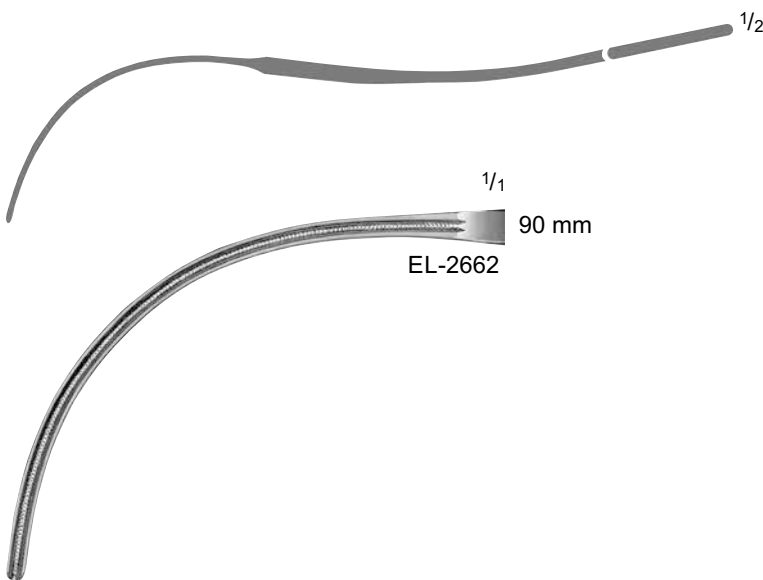

DEBAKEY Atraumatic Peripheral Clamp #2

Catalog Number	Jaw Length (mm)	Length (in.)
EL-2662	90	7 1/2

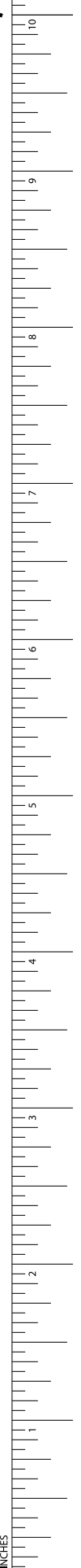

Cardiovascular
Vascular Clamps

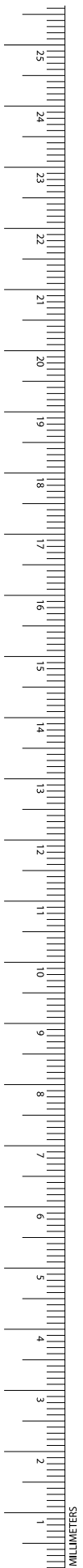

EL-2663

1/2

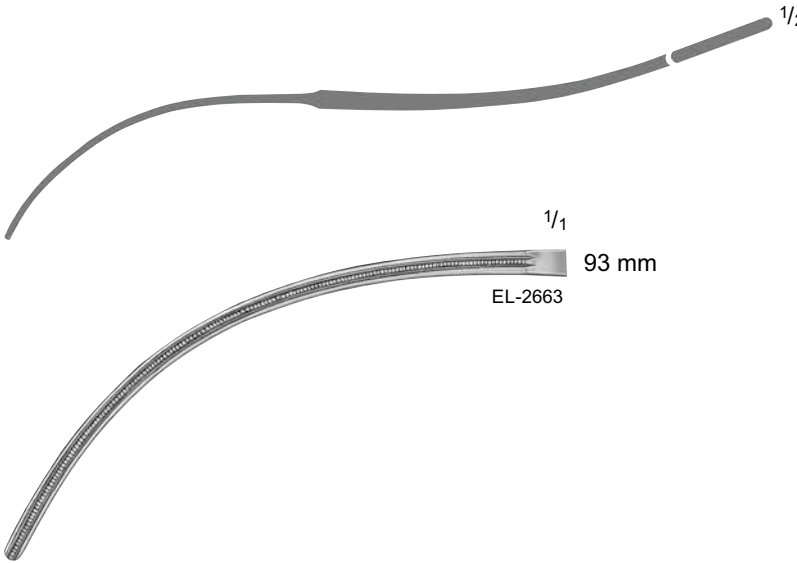

1/2

1/1

93 mm

EL-2663

DEBAKEY Atraumatic Peripheral Clamp #3

Catalog Number	Jaw Length (mm)	Length (in.)
EL-2663	93	7 7/8



EL-2664

1/2

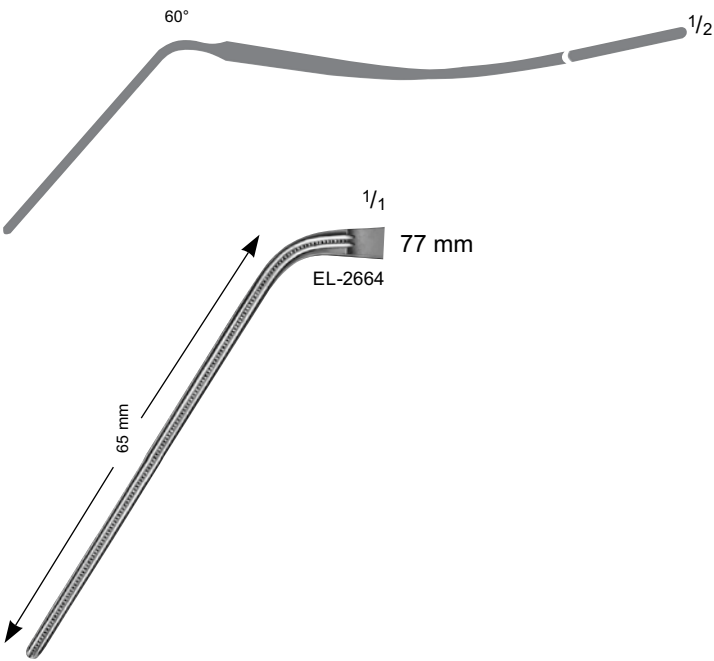

DEBAKEY Atraumatic Peripheral Clamp #4

Catalog Number	Jaw Angle	Jaw Length (mm)	Length (in.)
EL-2664	60°	77	7

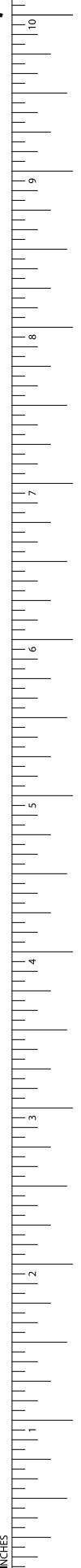

Cardiovascular
Vascular Clamps

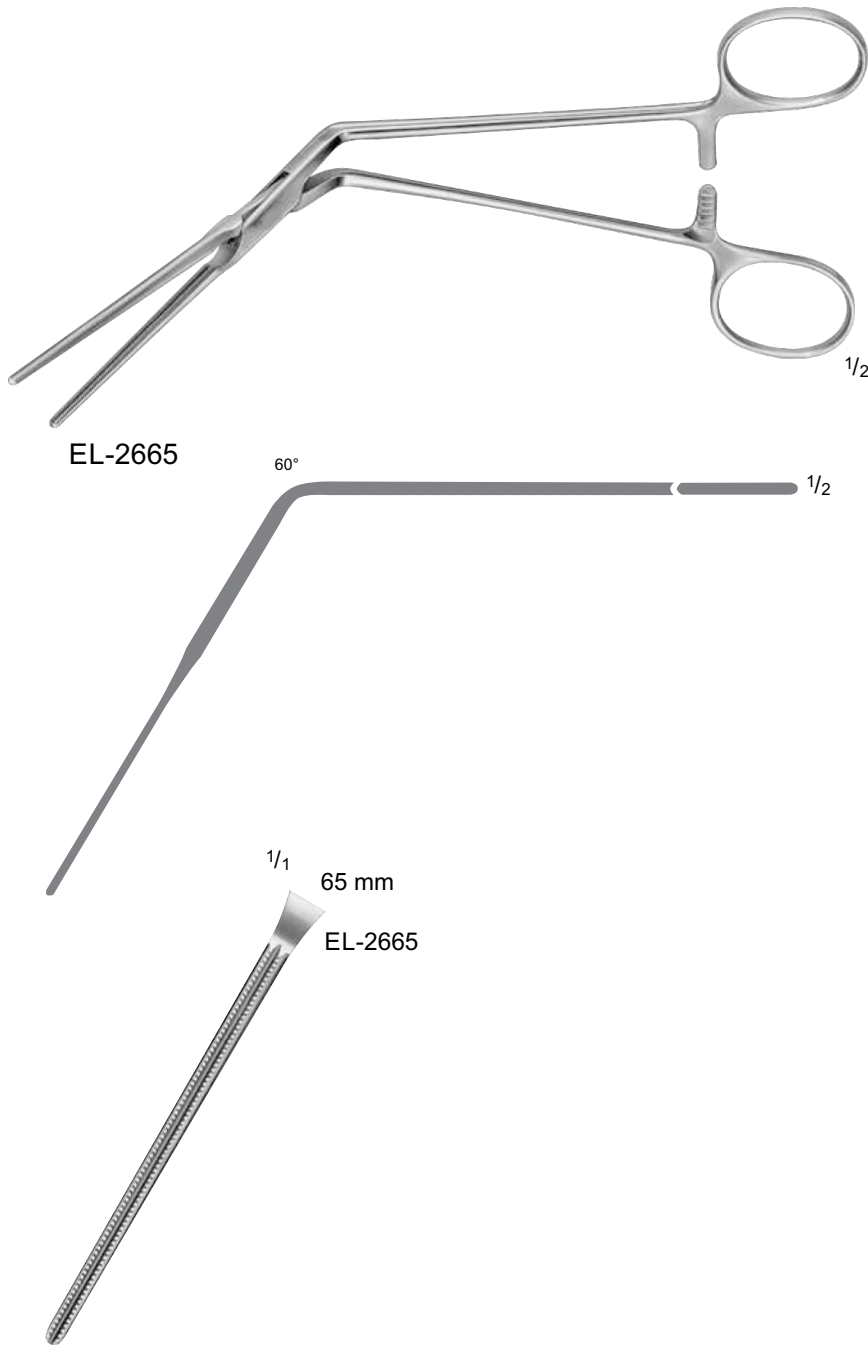
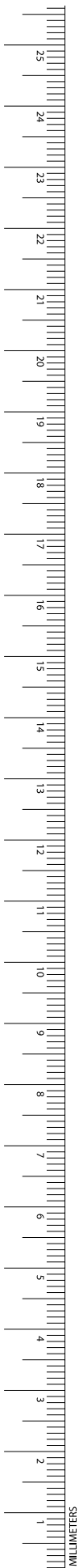

DEBAKEY Atraumatic Iliac Clamp

Catalog Number	Jaw Angle	Jaw Length (mm)	Length (in.)
EL-2665	60°	65	7 7/8

COOLEY Aortic Aneurysm Clamp

Catalog Number	Jaw	Jaw Length (mm)	Length (in.)
EL-2666	CVD	75	10

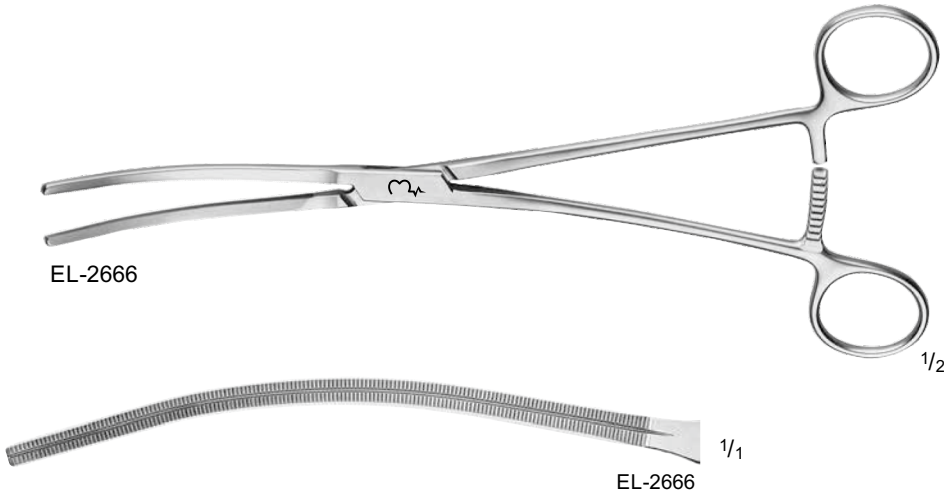

Cardiovascular
Vascular Clamps

**DEBAKEY Atraumatic Aortic Aneurysm
Clamp, Light Curved**

Catalog Number	Jaw	Jaw Length (mm)	Length (in.)
EL-2667	2 x 3 SERR	95	9 3/4
EL-2668	2 x 3 SERR	110	11 3/4
EL-2669	2 x 3 SERR	130	12 3/8
EL-2670	2 x 3 SERR	140	12 3/4



EL-2667-EL-2670



EL-2667 1/1



EL-2668 1/1



EL-2669 1/1

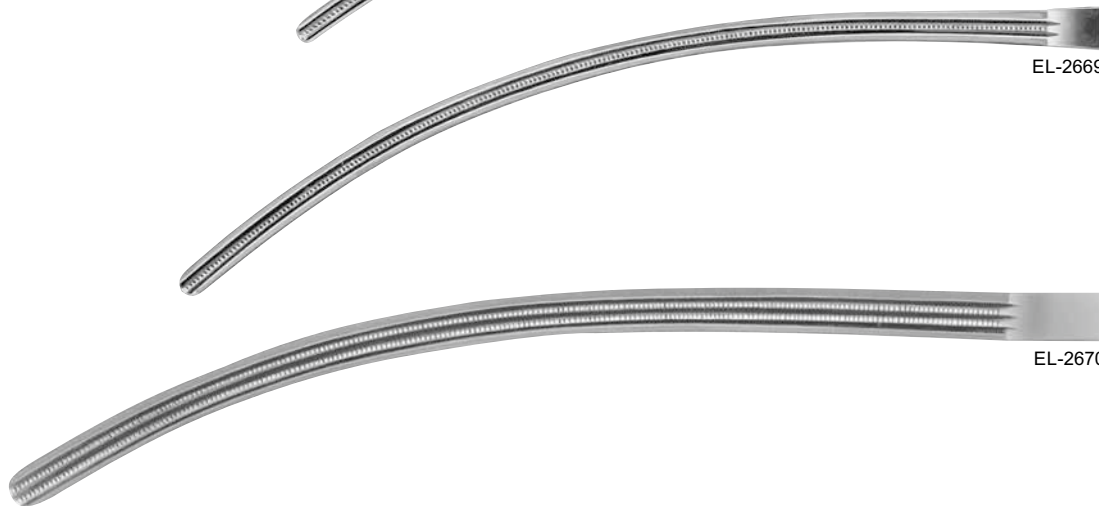

EL-2670 1/1

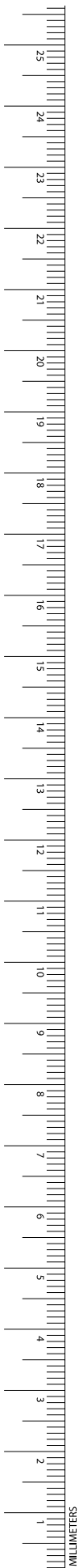

DEBAKEY Atraumatic Aortic Aneurysm Clamp

Catalog Number	Jaw	Jaw Length (mm)	Length (in.)
EL-2671	SLIGHT-CVD	70	10
EL-2672	CVD	75	10 1/2
EL-2673	HEAVY-CVD	85	11



EL-2671-EL-2673

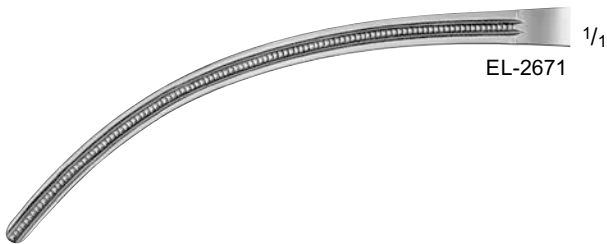

EL-2671

1/1

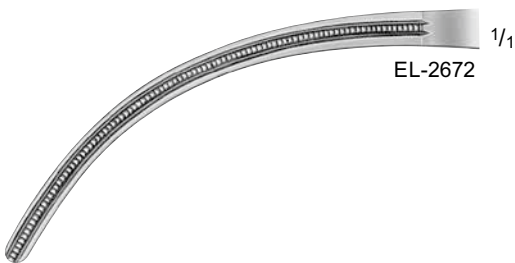

EL-2672

1/1

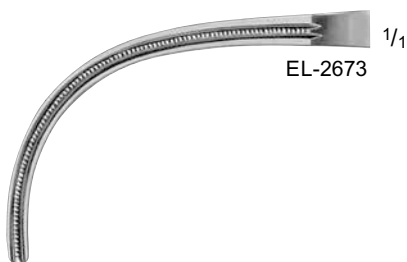

EL-2673

1/1

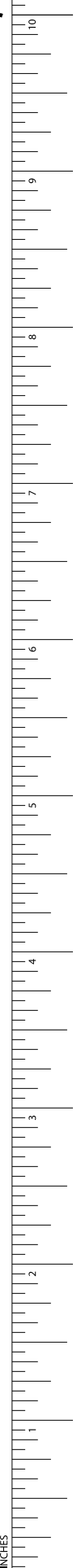

Cardiovascular
Vascular Clamps

DEBAKEY Atraumatic Aortic Aneurysm Clamp, S-Curved

Catalog Number	Jaw Length (mm)	Length (in.)
EL-2674	115	11 3/4

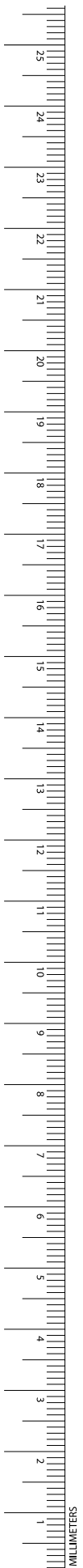

EL-2674

1/2



1/2



EL-2674

1/1

**DEBAKEY-SEMB Atraumatic Aortic
Aneurysm Clamp, Curved**

Catalog Number	Jaw Length (mm)	Length (in.)
EL-2675	100	10 1/2



EL-2675

1/2



EL-2675

1/1

1/2

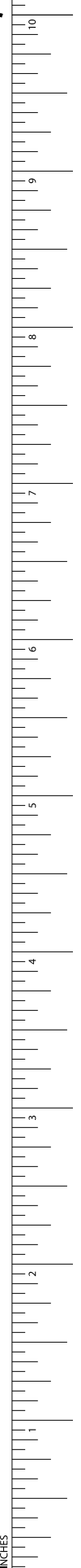

INCHES

Cardiovascular
Vascular Clamps

**DEBAKEY Atraumatic Aortic Aneurysm
Clamp, Full Curved**

Catalog Number	Jaw Length (mm)	Length (in.)
EL-2676	111	10 5/8



EL-2676

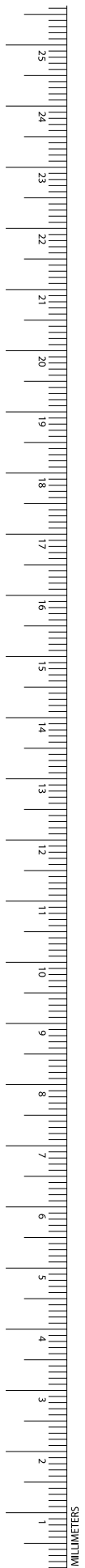
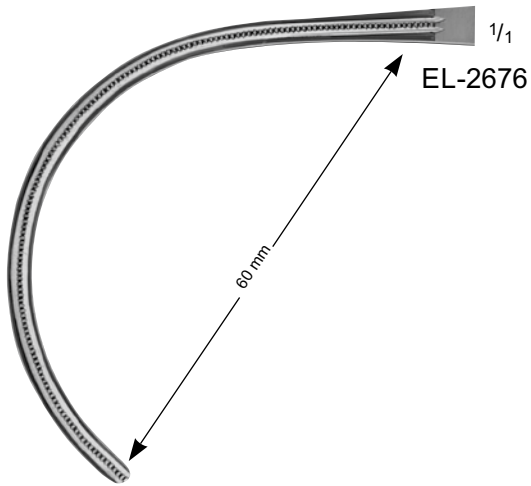
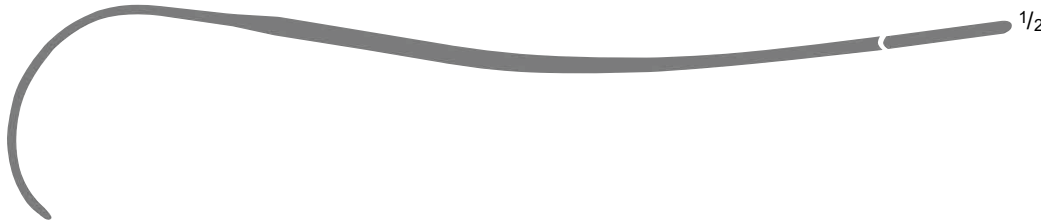

WEBER Atraumatic Aortic Clamp, Left

Catalog Number	Jaw Length (mm)	Length (in.)
EL-2677	113	10 1/4

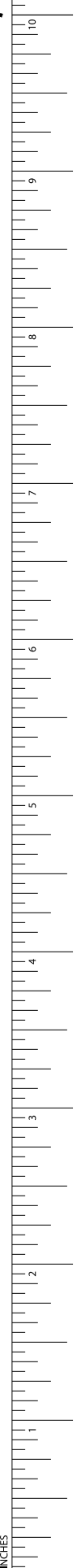
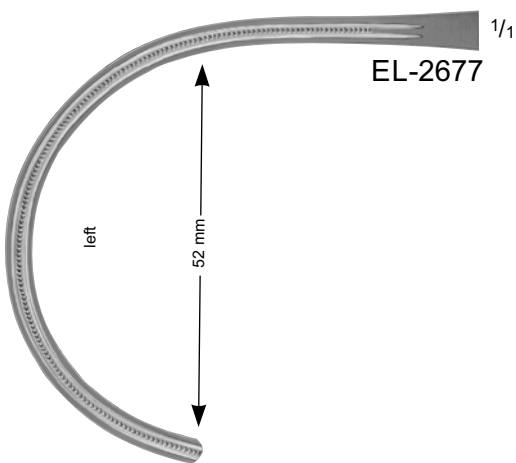
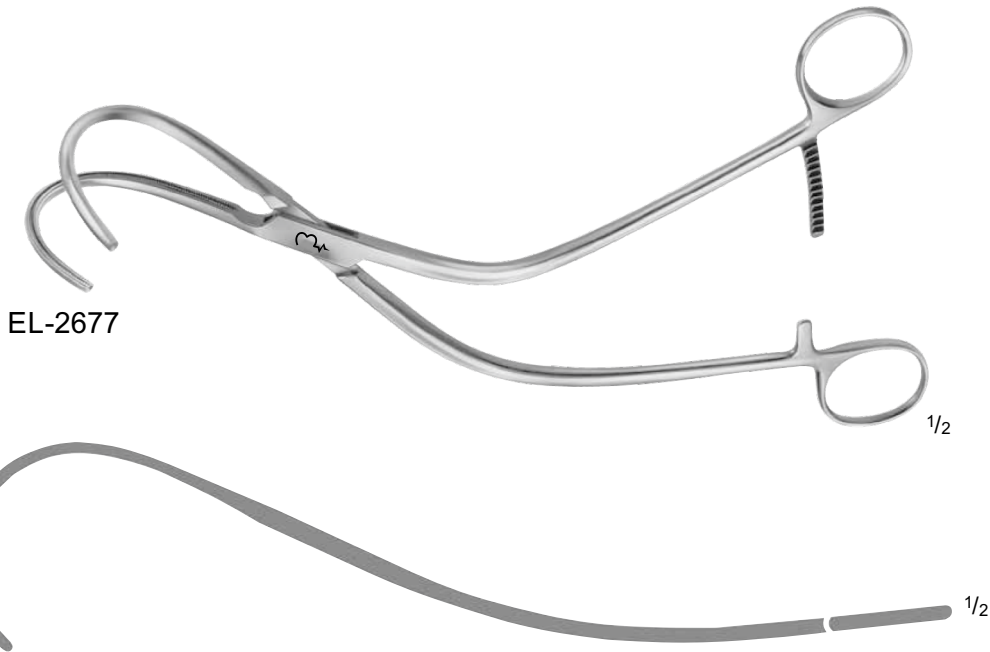

Cardiovascular
Vascular Clamps

WEBER Atraumatic Aortic Clamp, Right

Catalog Number	Jaw Length (mm)	Length (in.)
EL-2678	113	10 1/4



EL-2678

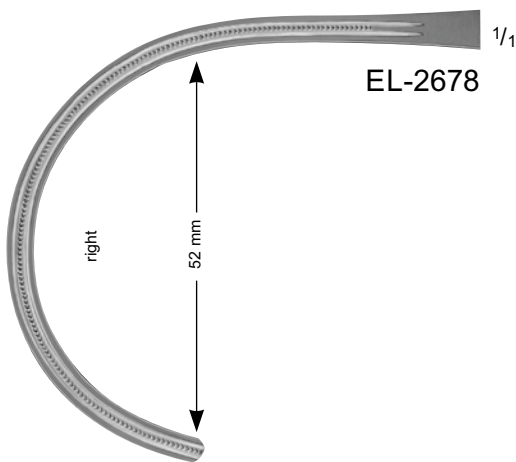

EL-2678

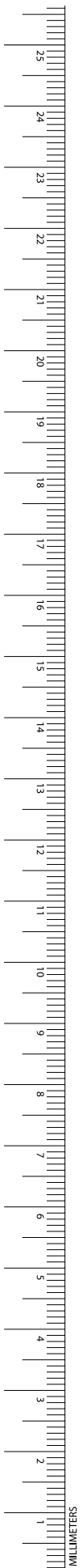

LAMBERT-KAY Atraumatic Aortic Clamp

Catalog Number	Weight	Jaw Length (mm)	Length (in.)
EL-2679	LIGHT	93	8 1/2
EL-2680	HEAVY	100	8 1/4

EL-2679-EL-2680

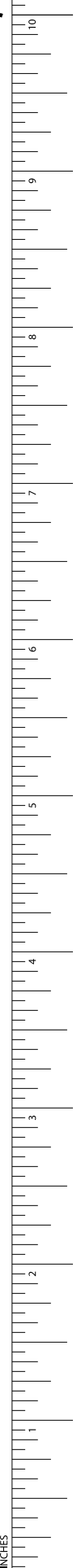
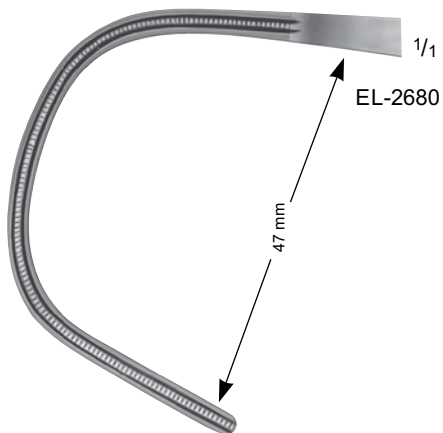
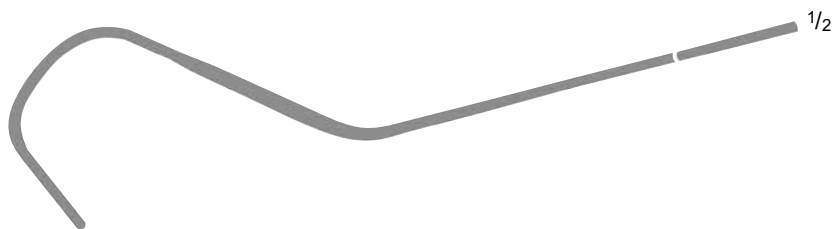
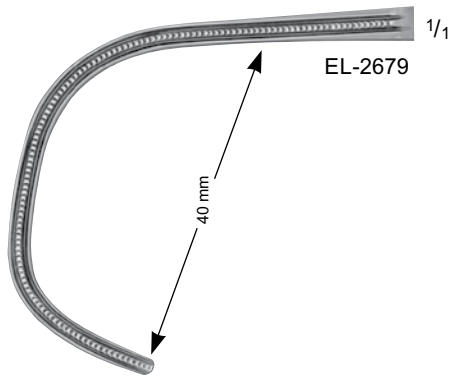

Cardiovascular
Vascular Clamps

DEBAKEY-LAMBERT Atraumatic Aortic Clamp

Catalog Number	Jaw Angle	Jaw Length (mm)	Length (in.)
EL-2681	MULTI	40	10

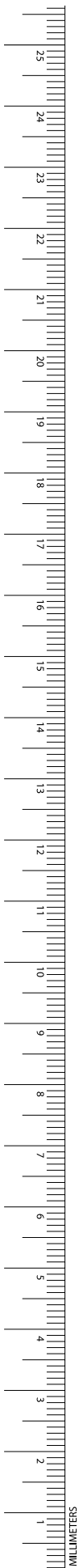
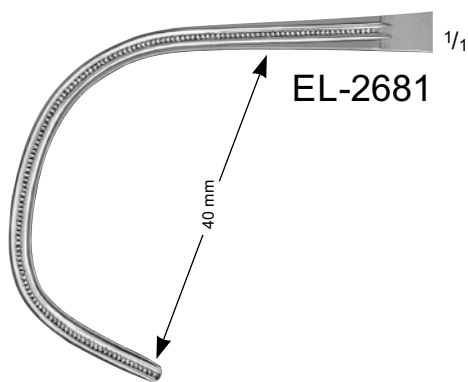

MORRIS Atraumatic Aortic Cross Clamp

Catalog Number	Jaw Angle	Jaw Length (mm)	Length (in.)
EL-2682	70°	67	6 7/8

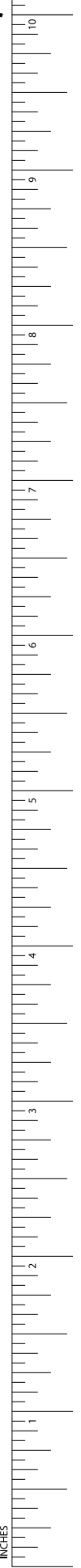
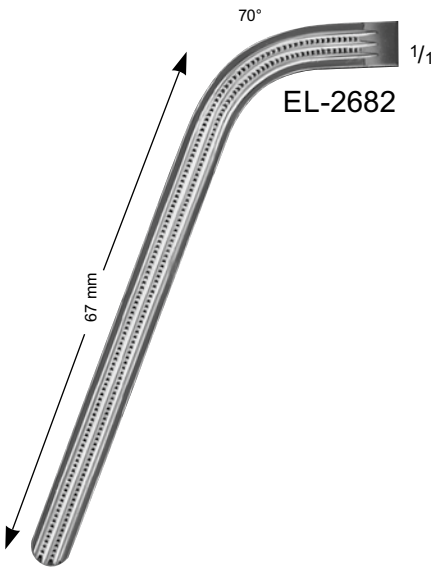
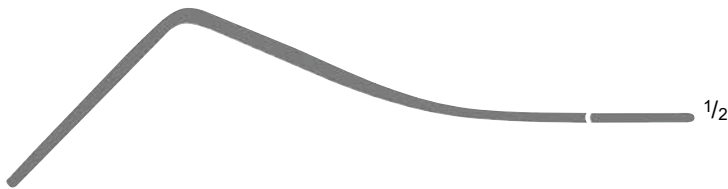

Cardiovascular
Vascular Clamps

DEBAKEY-MORRIS Atraumatic Cross-Clamp

Catalog Number	Jaw Angle	Jaw Length (mm)	Length (in.)
EL-2683	70°	70	9 1/2

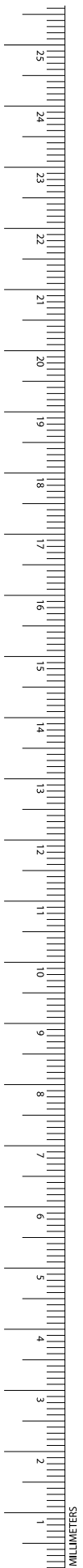
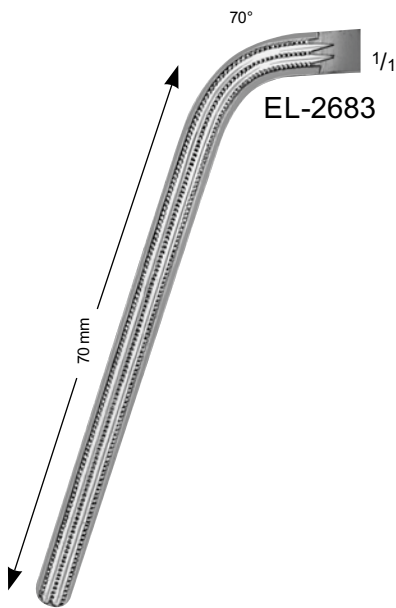
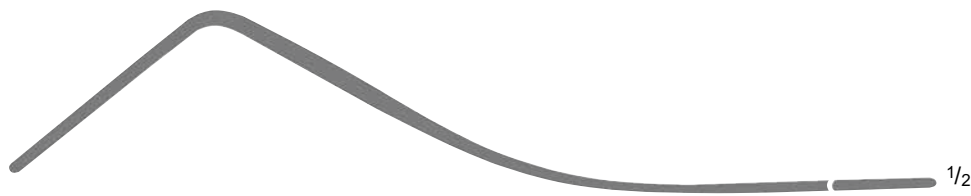

OCHSNER Atraumatic Aortic Clamp

Catalog Number	Jaw Angle	Jaw Length (mm)	Length (in.)
EL-2684	70°	50	10 1/4



EL-2684

1/2

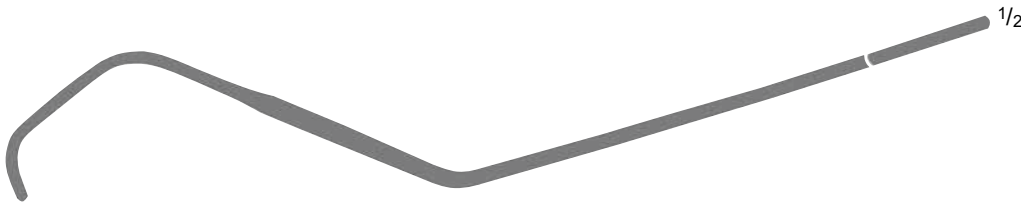

1/2

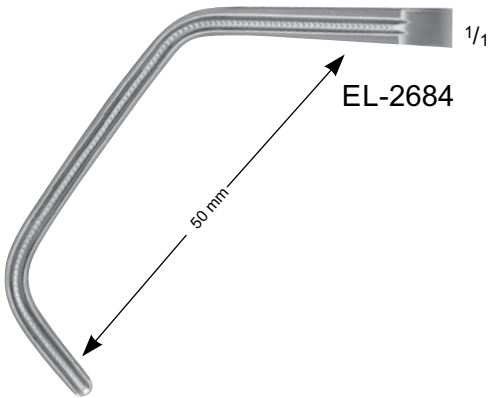

EL-2684

50 mm

1/1

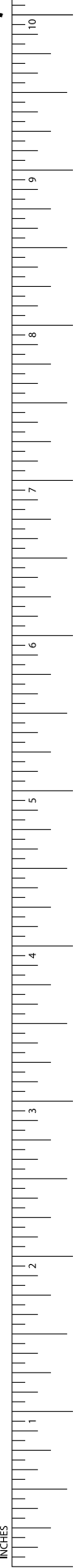

Cardiovascular
Vascular Clamps

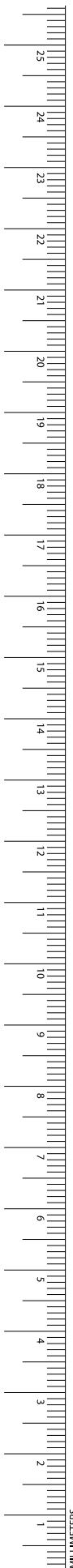

EL-2685-EL-2686

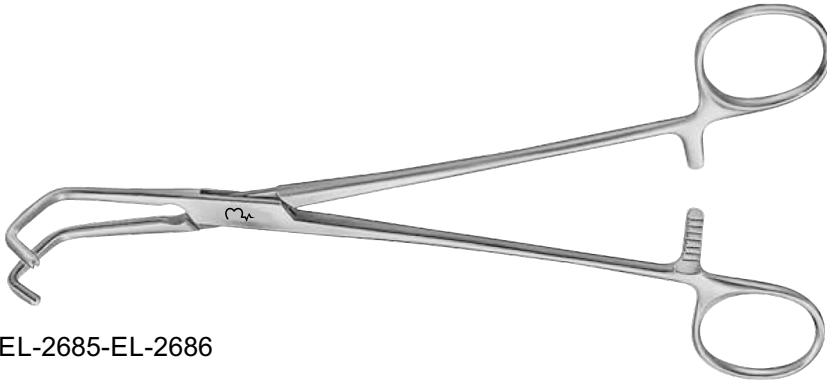

DEBAKEY-BECK Atraumatic Vena Cava Clamp

Catalog Number	Jaw Length (mm)	Length (in.)
EL-2685	30	8
EL-2686	45	8 1/4

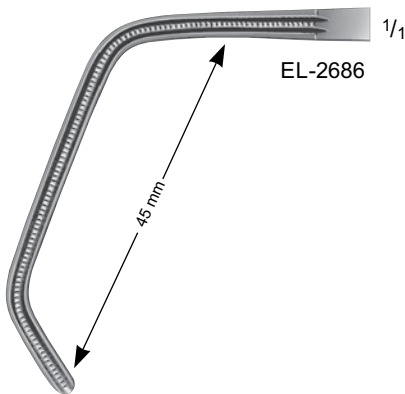
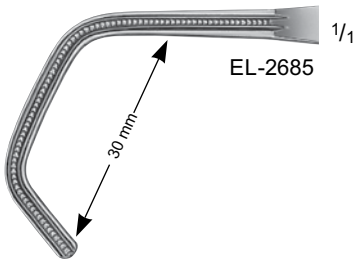



ER-2687-ER-2691

DEBAKEY Atraumatic Tangential Clamp

Catalog Number	Jaw Size (#)	Jaw Length (mm)	Length (in.)
EL-2687	1	38	8 3/4
EL-2688	2	48	10 1/2
EL-2689	3	54	10 5/8
EL-2690	4	58	10 5/8
EL-2691	5	75	11

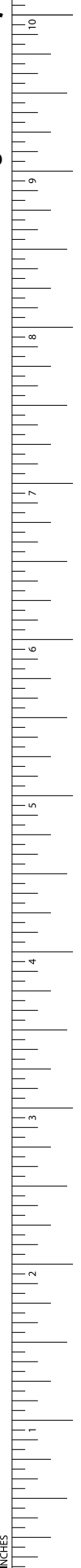
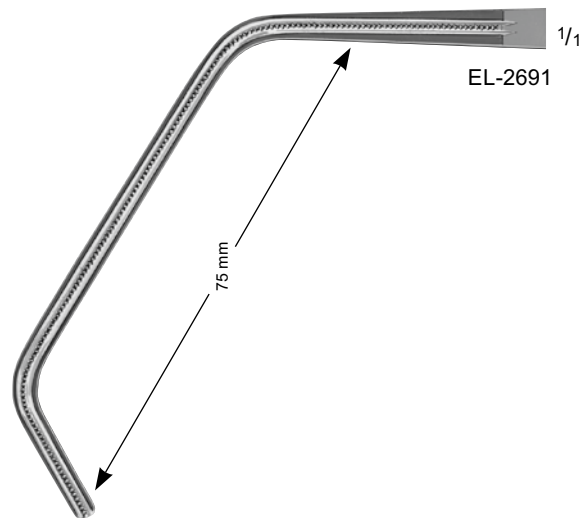
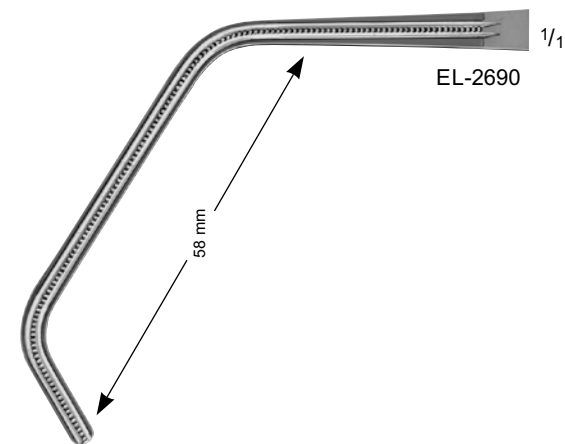
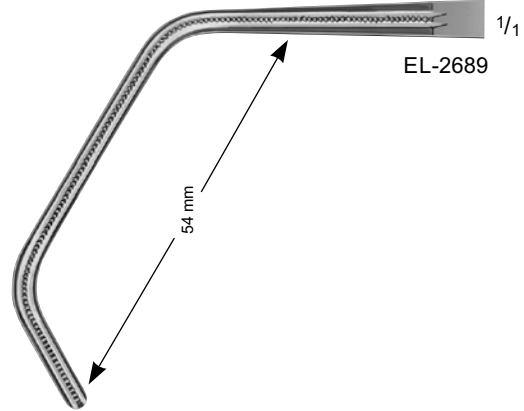
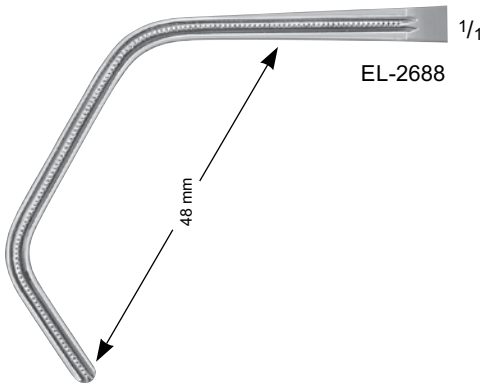
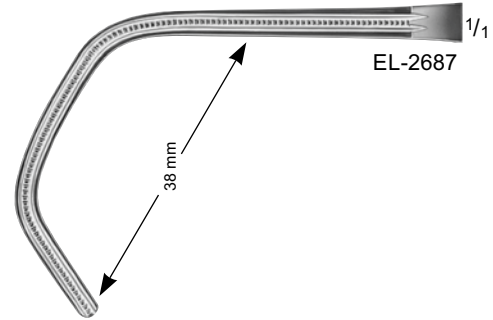

Cardiovascular
Vascular Clamps

DEBAKEY-SATINSKY Atraumatic Tangential Clamp

Catalog Number	Jaw Length (mm)	Length (in.)
EL-2692	32	9 1/4
EL-2693	40	9 1/2
EL-2694	47	9 5/8



EL-2692-EL-2694

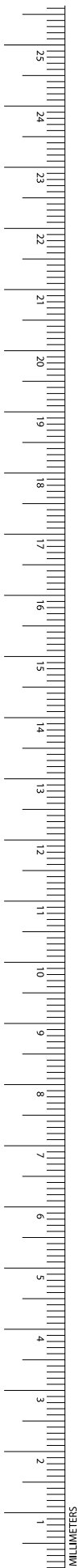
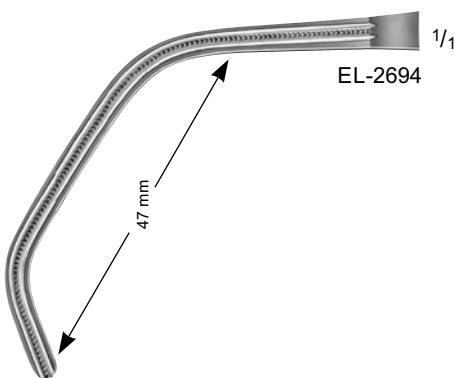
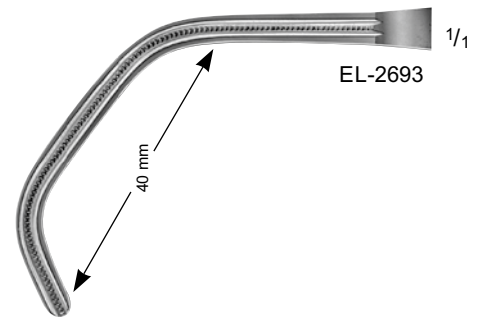
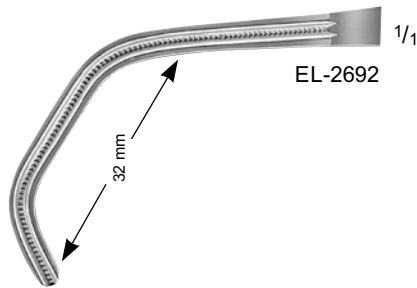

**DEBAKEY Atraumatic Sidewinder
Aortic Clamp**

Catalog Number	Jaw Angle	Jaw Length (mm)	Length (in.)
EL-2695	70°	60	10 1/2



EL-2695

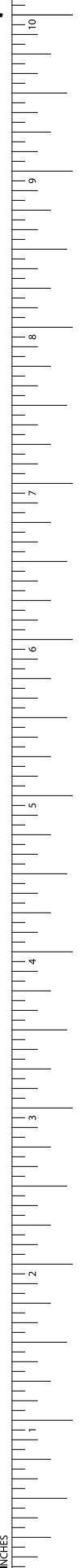
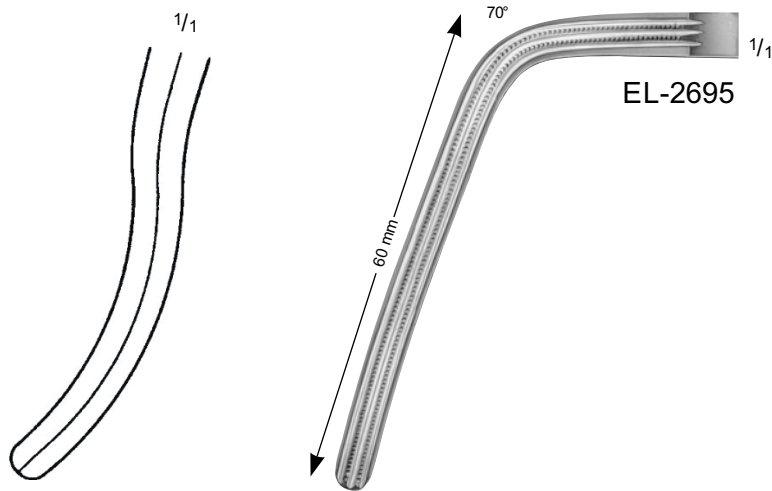

Cardiovascular
Vascular Clamps

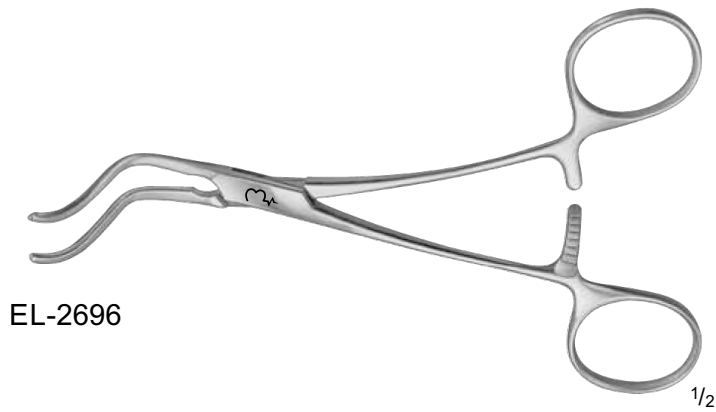
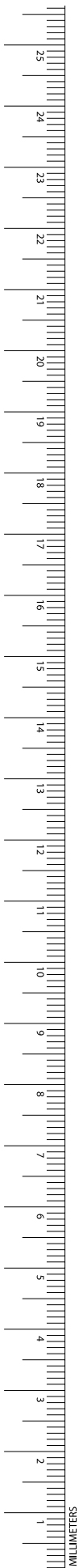

DEBAKEY-SUBRAMANIAN Atraumatic Aortic Clamp

Catalog Number	Jaw Angle	Jaw Length (mm)	Length (in.)
EL-2696	70°	30	6 1/8

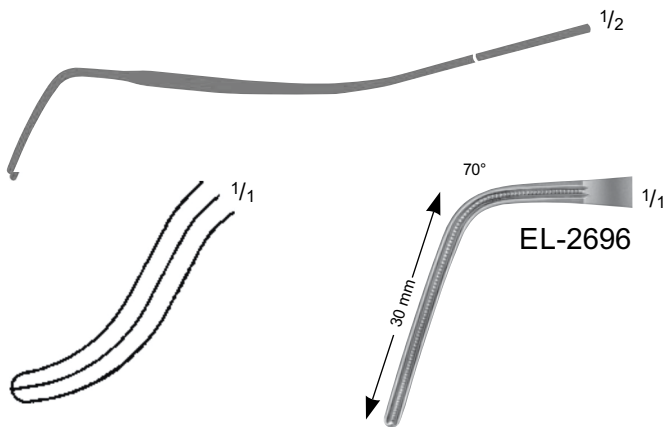

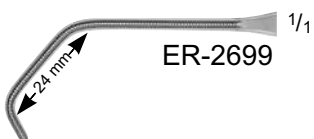
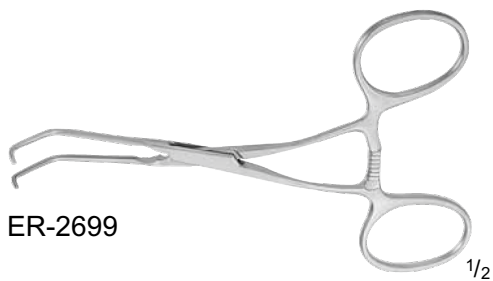
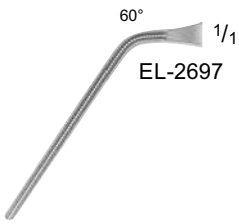
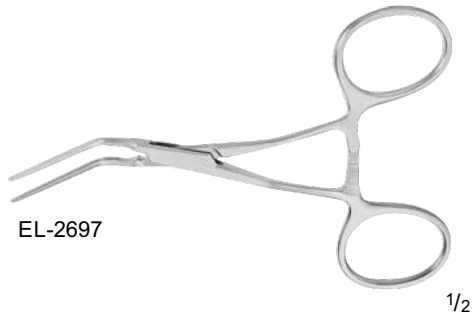

DEBAKEY Vascular Clamp

Catalog Number	Jaw Angle	Jaw Length (mm)	Length (in.)
EL-2697	60°	40	4 1/4
EL-2698	90°	40	3 3/4

DEBAKEY Partial Occlusion Clamp

Catalog Number	Jaw Angle	Jaw Length (mm)	Length (in.)
EL-2699	MULTI	24	4 1/2

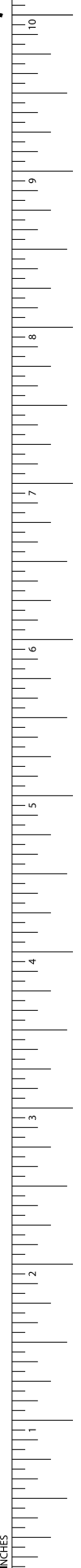

Cardiovascular

Vascular Clamps

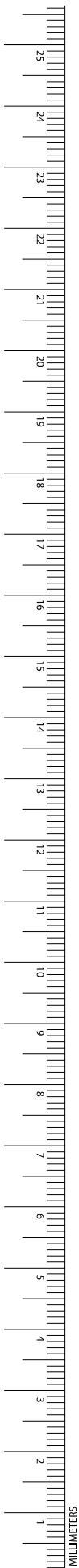

EL-2700-EL-2701

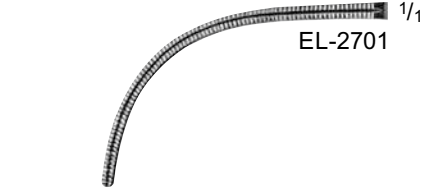

EL-2702

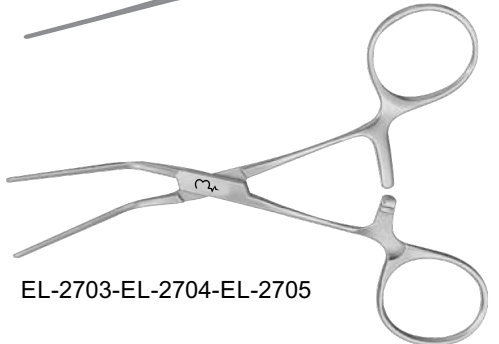
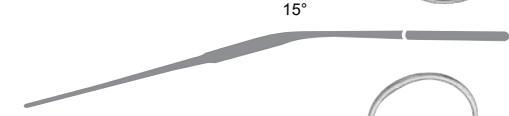

EL-2703-EL-2704-EL-2705

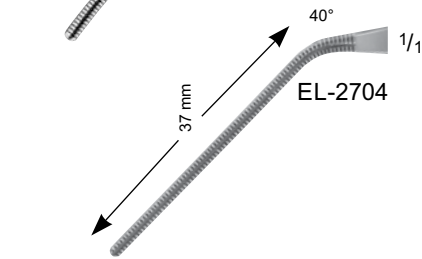

EL-2706-EL-2707



EL-2708

1/2

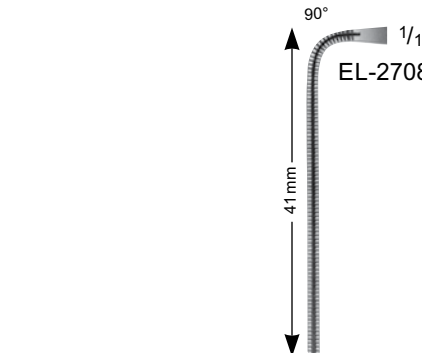

COOLEY Atraumatic Ring Handle Bulldog Clamp

Catalog Number	Shaft Angle	Jaw Angle	Jaw Length (mm)	Length (in.)
EL-2700	STR	STR	50	5
EL-2701	STR	CVD	50	4 1/2
EL-2702	15° ANG	STR	50	5
EL-2703	SLIGHT-CVD	CVD	50	5
EL-2704	SLIGHT-CVD	40°	37	4 3/4
EL-2705	SLIGHT-CVD	MULTI	52	5
EL-2706	CVD	MULTI	50	4 3/4
EL-2707	CVD	MULTI	12	4 1/4
EL-2708	ANG	90°	41	4

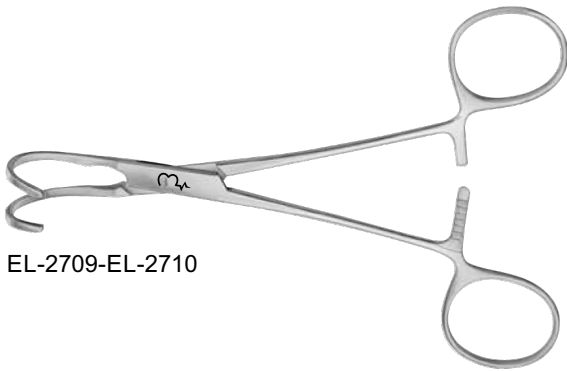

EL-2709-EL-2710

COOLEY-BECK Atraumatic Pediatric Clamp, Curved

Catalog Number	Jaw Length (mm)	Length (in.)
EL-2709	25	6
EL-2710	30	6 1/8

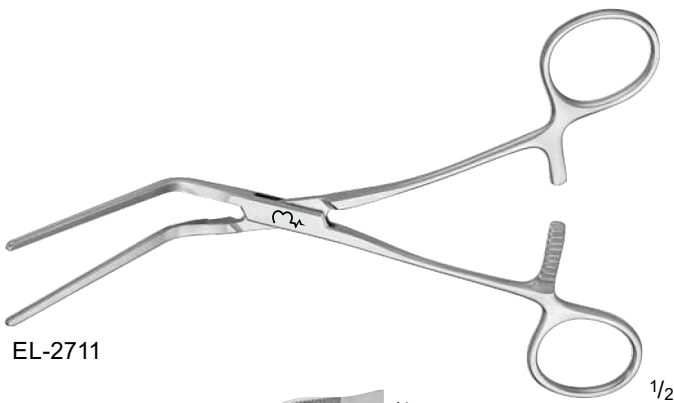
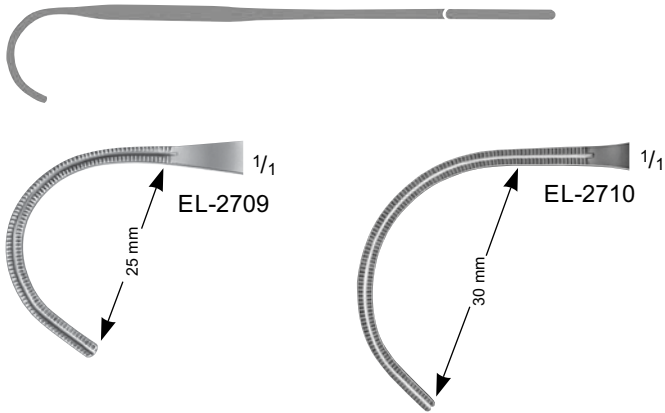

EL-2711



COOLEY Atraumatic Peripheral Vascular Clamp, Angled

Catalog Number	Jaw Length (mm)	Length (in.)
EL-2711	65	7

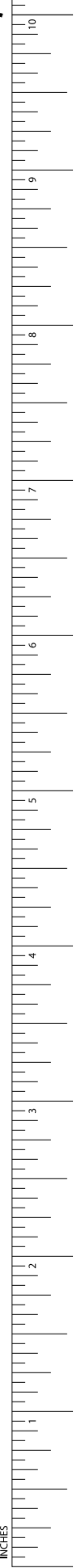

Cardiovascular
Vascular Clamps

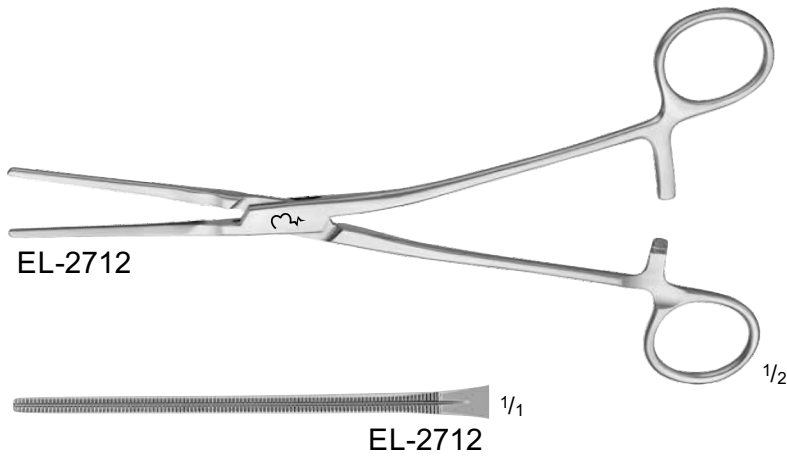
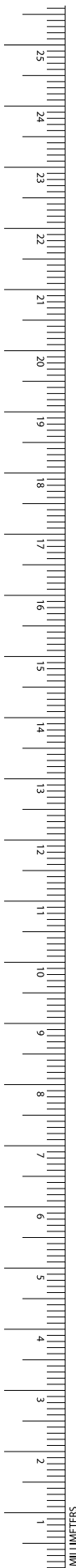

**COOLEY Atraumatic Coarctation Clamp,
Straight Jaw, Angled Shaft**

Catalog Number	Jaw Length (mm)	Length (in.)
EL-2712	60	8 3/4

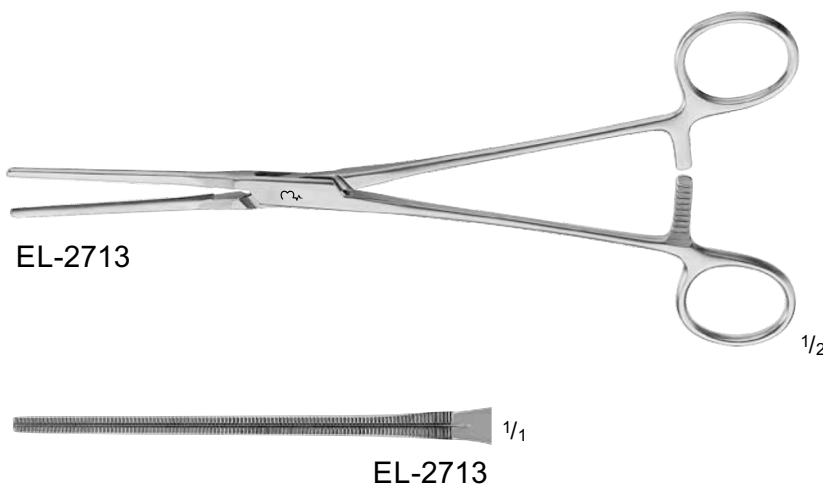

**COOLEY Atraumatic Coarctation Clamp,
Straight Jaw, Straight Shaft**

Catalog Number	Jaw Length (mm)	Length (in.)
EL-2713	50	8 3/4

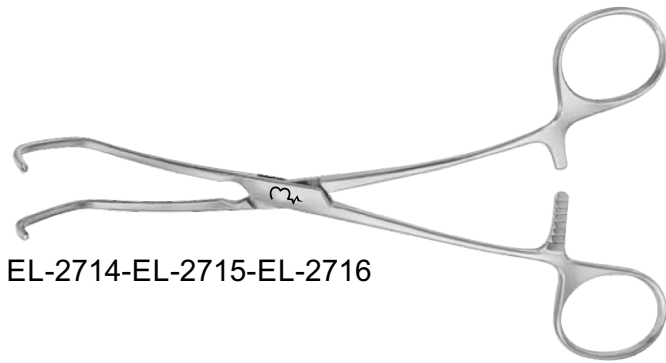
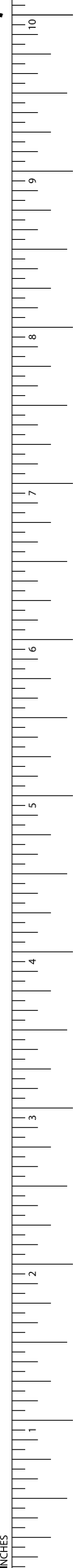

EL-2714-EL-2715-EL-2716

DERRA-COOLEY Atraumatic Clamp

Catalog Number	Jaw Length (mm)	Length (in.)
EL-2714	16	6 3/4
EL-2715	21	6 7/8
EL-2716	27	6 7/8

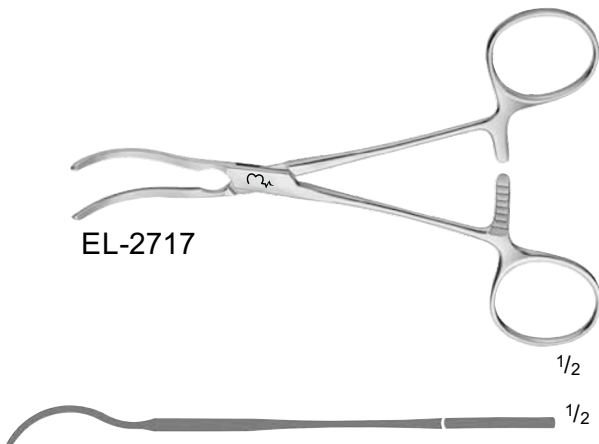
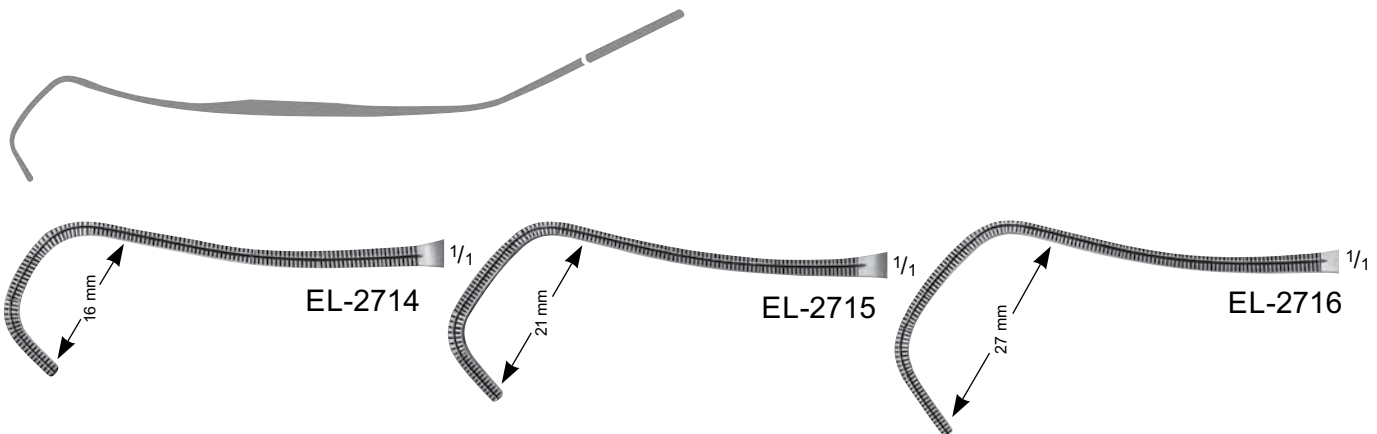

EL-2717

COOLEY Atraumatic Clamp, Spoon Shaped

Catalog Number	Jaw Length (mm)	Length (in.)
EL-2717	42	5 3/4

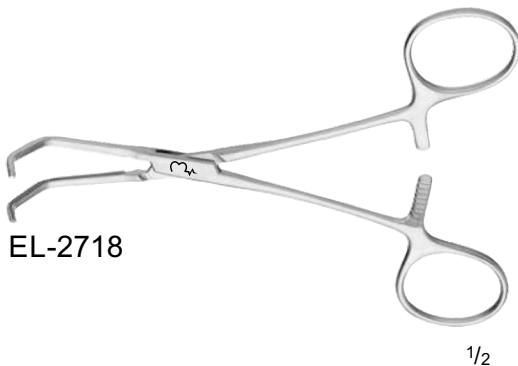

EL-2718

COOLEY-SATINSKY Atraumatic Pediatric Clamp

Catalog Number	Jaw Length (mm)	Length (in.)
EL-2718	21	5 1/2

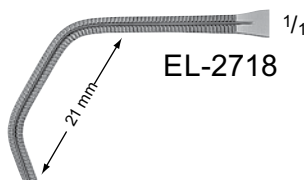

Cardiovascular Vascular Clamps

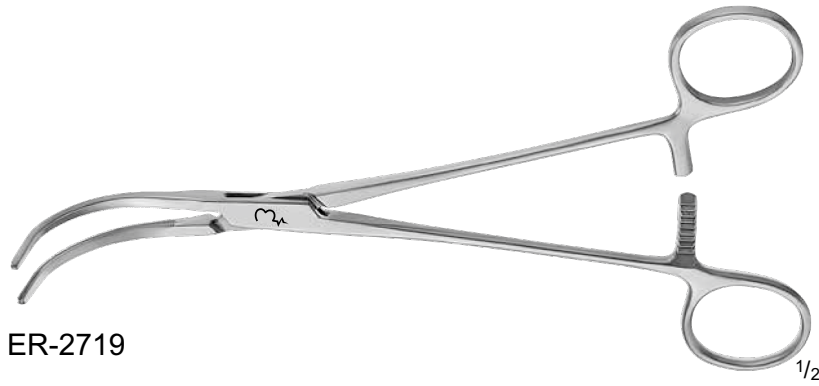
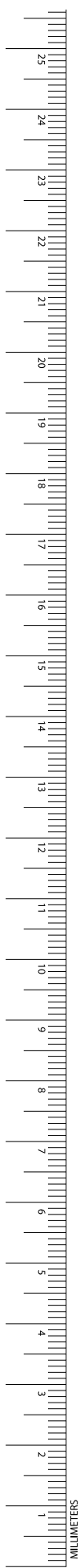

ER-2719

COOLEY Atraumatic Cardiovascular Clamp, Curved

Catalog Number	Jaw Length (mm)	Length (in.)
EL-2719	55	8 1/4

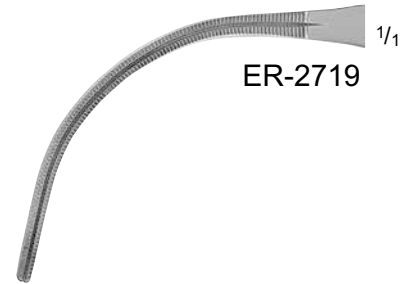

ER-2719

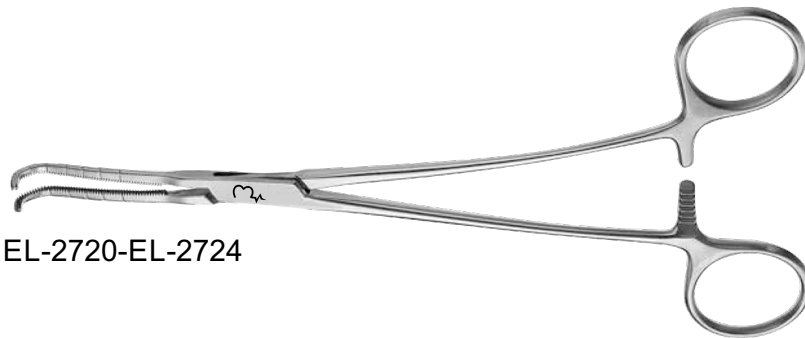

EL-2720-EL-2724

HENDREN Atraumatic Cardiovascular Clamp

Catalog Number	Jaw Length (mm)	Length (in.)
EL-2720	13	8 1/4
EL-2721	30	8 1/2
EL-2722	35	8 1/2
EL-2723	40	8 3/4
EL-2724	45	8 3/4

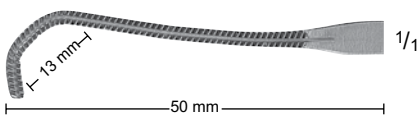

EL-2720

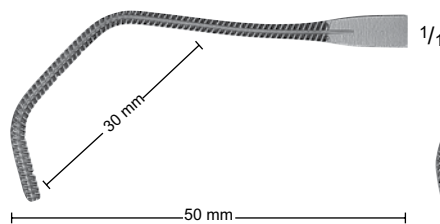

EL-2721

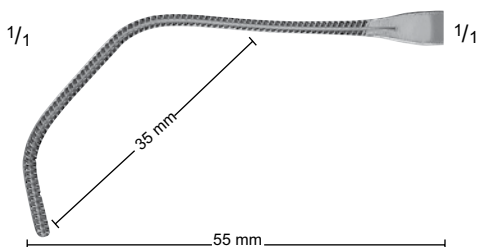

EL-2722

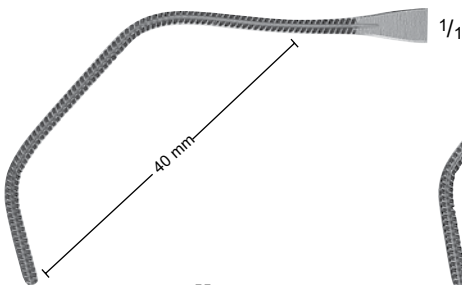

EL-2723

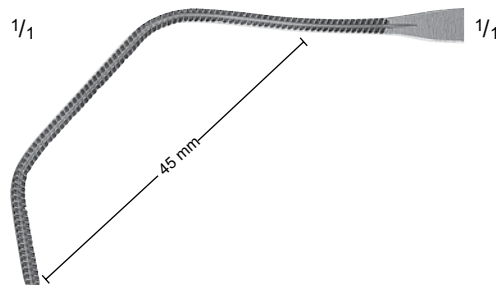

EL-2724

COOLEY Atraumatic Pediatric Anastomosis Clamp, Curved

Catalog Number	Jaw Length (mm)	Length (in.)
EL-2725	36	6 3/4
EL-2726	44	6 3/4

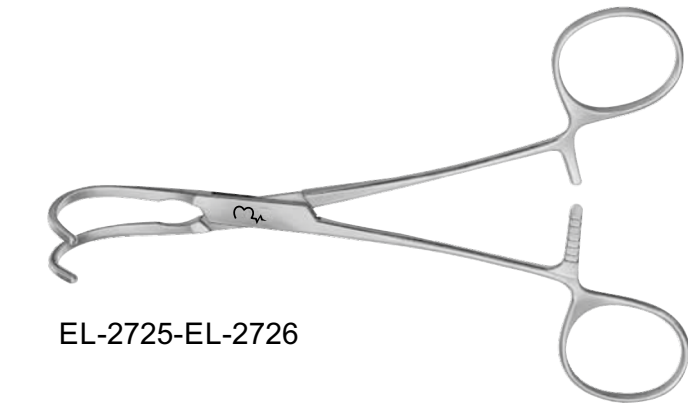

EL-2725-EL-2726

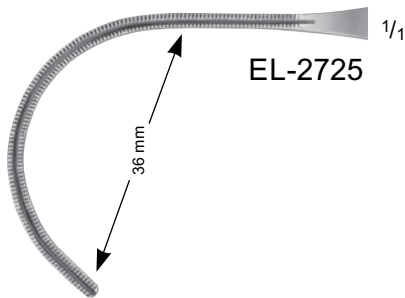
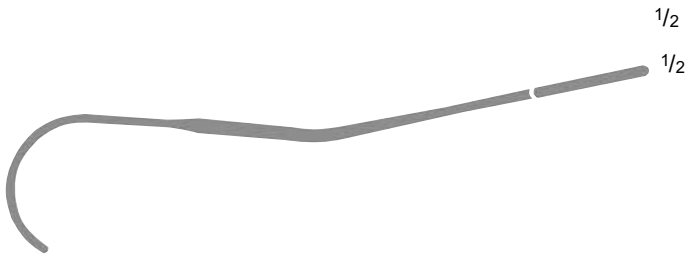

EL-2725

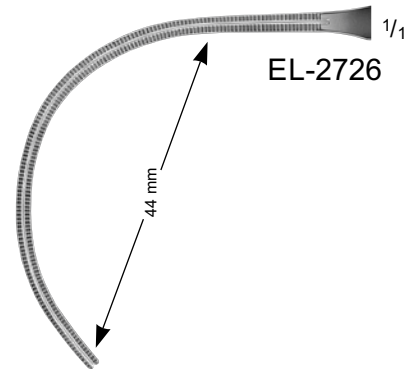

EL-2726

POTTS Anastomosis Clamp

Catalog Number	Jaw Angle	Jaw Length (mm)	Length (in.)
EL-2727	90°	40	7 1/4

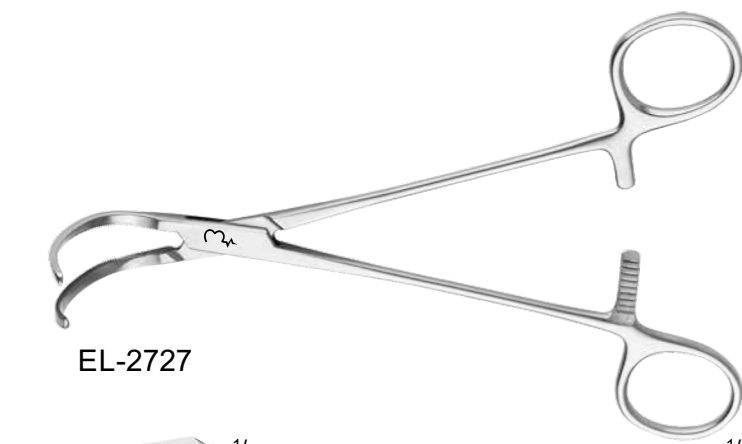

EL-2727



EL-2727

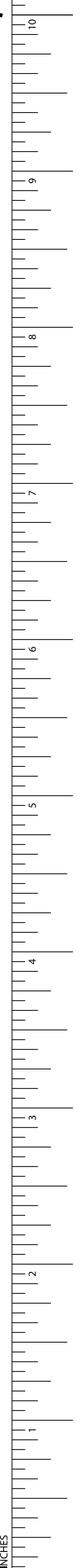

Cardiovascular
Vascular Clamps

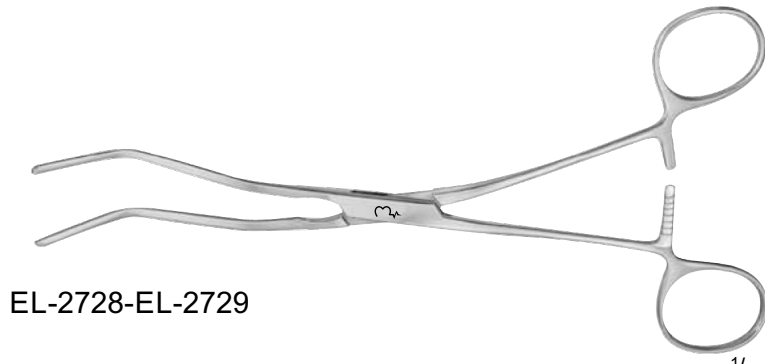
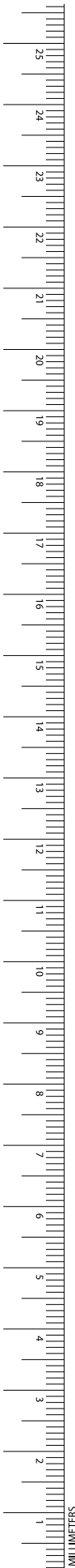

EL-2728-EL-2729



EL-2728



EL-2729

COOLEY Atraumatic Carotid and Subclavian Clamp

Catalog Number	Jaw Length (mm)	Length (in.)
EL-2728	74	7 1/4
EL-2729	86	7 3/4

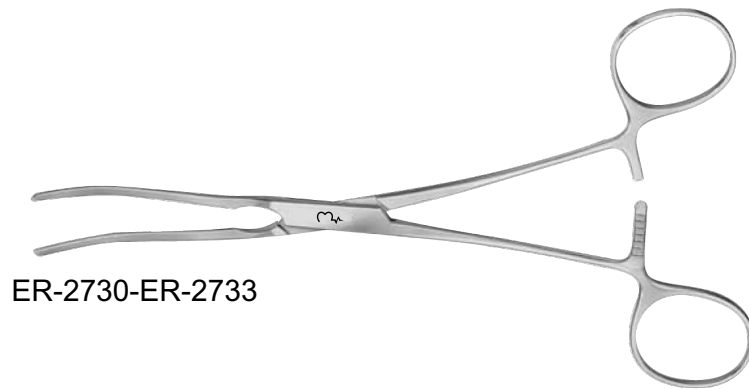

ER-2730-ER-2733



EL-2730



EL-2731

COOLEY Atraumatic Patent Ductus Clamp, Straight Shaft

Catalog Number	Jaw Length (mm)	Jaw	Length (in.)
EL-2730	41	STR	6 1/4
EL-2731	52	STR	6 3/4
EL-2732	52	LIGHT-CVD	7
EL-2733	63	S-CVD	7



EL-2732



EL-2733

COOLEY Atraumatic Patent Ductus Clamp, Angled Shaft

Catalog Number	Jaw Angle	Jaw Length (mm)	Length (in.)
EL-2734	STR	41	6 1/4
EL-2735	STR	52	6 3/4
EL-2736	60°	57	6 1/2
EL-2737	60°	67	6 3/4
EL-2738	60°	82	7 1/4

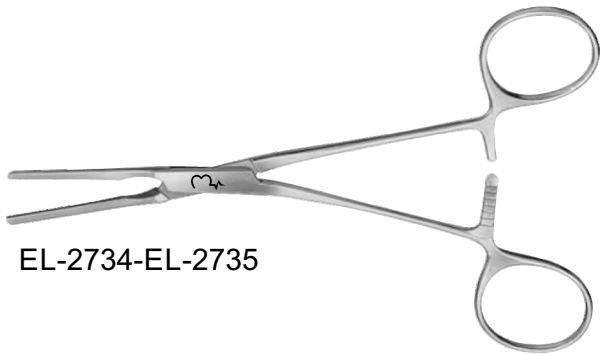

EL-2734-EL-2735



EL-2734



EL-2735



EL-2736-EL-2738

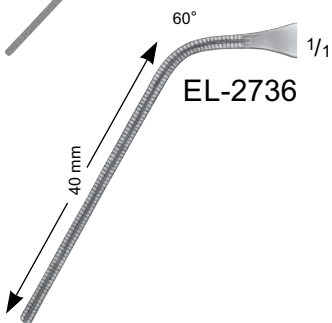
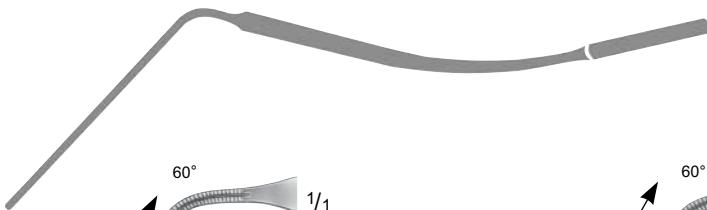

EL-2736

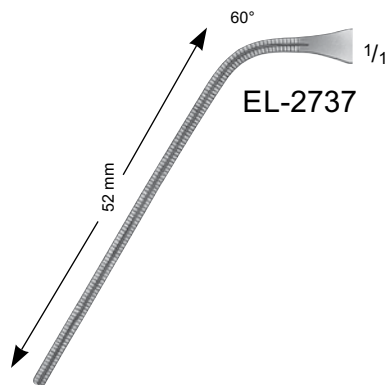

EL-2737

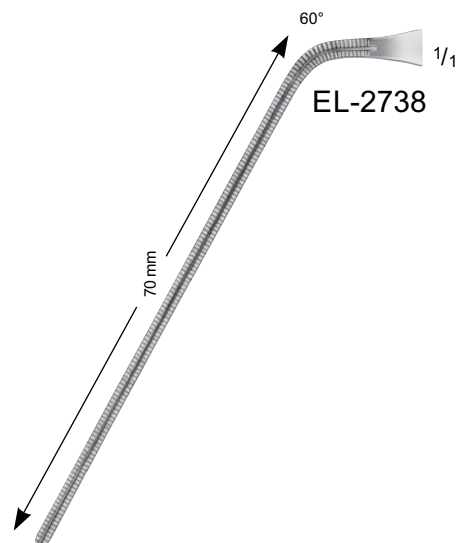

EL-2738

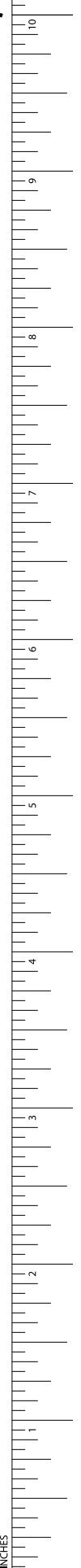

Cardiovascular
Vascular Clamps

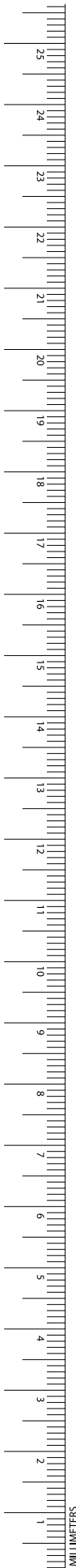

ER-27-39-ER-2747

COOLEY Cava Occlusion Clamp

Catalog Number	Jaw Size (FR)	Length (in.)
EL-2739	20	6 1/4
EL-2740	24	6 1/4
EL-2741	26	7 1/2
EL-2742	28	7 1/2
EL-2743	30	7 1/2
EL-2744	32	7 1/2
EL-2745	34	7 1/2
EL-2746	36	7 1/2
EL-2747	40	7 1/2



EL-2739



EL-2741



EL-2743



EL-2745



EL-2747



EL-2740



EL-2742



EL-2744



EL-2746

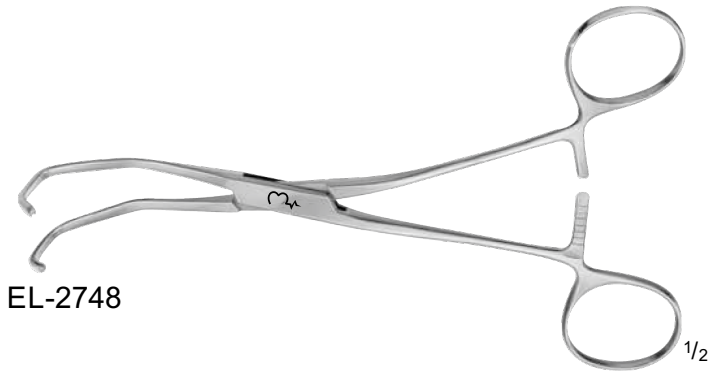

EL-2748

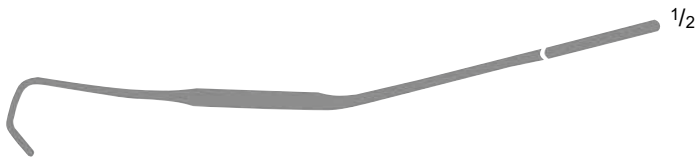

1/2

COOLEY Atraumatic Pediatric Anastomosis Clamp, Angled Shaft

Catalog Number	Jaw Length (mm)	Length (in.)
EL-2748	17	6 3/4
EL-2749	25	6 1/2
EL-2750	28	6 1/2
EL-2751	33	6 7/8
EL-2752	36	7

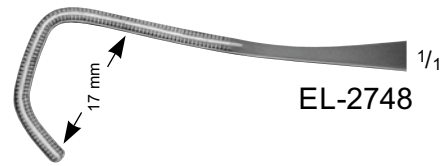

EL-2748

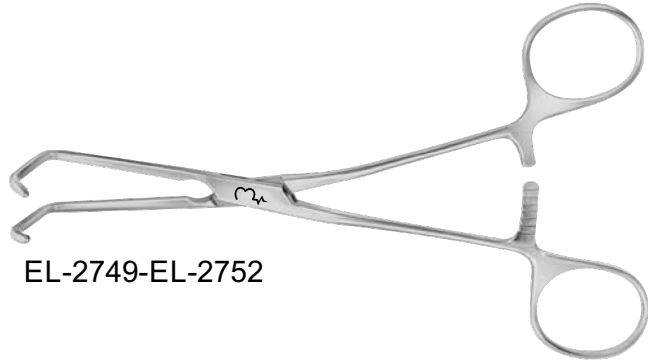

EL-2749-EL-2752

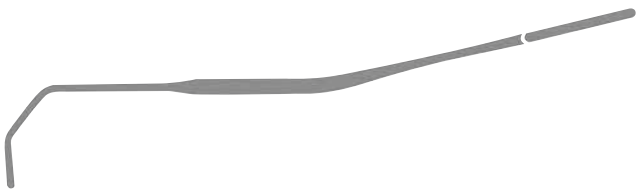

1/2

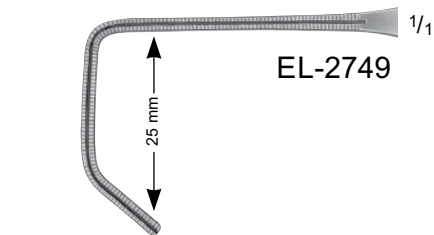

EL-2749

1/16

25 mm

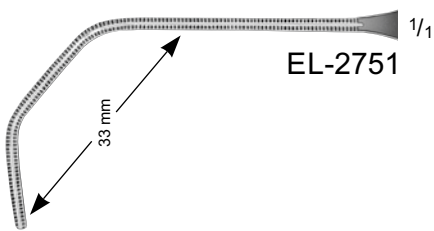

EL-2751

1/16

33 mm

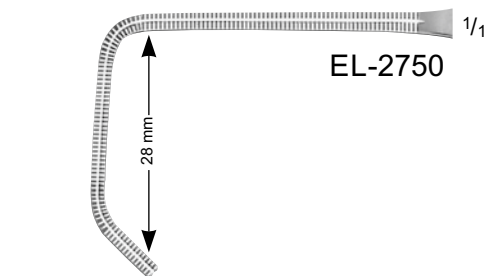

EL-2750

1/16

28 mm

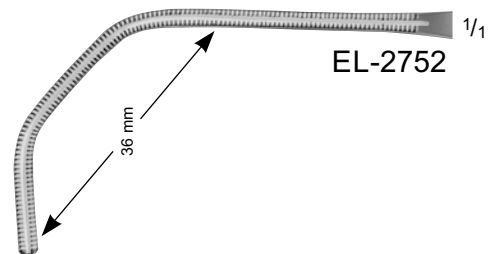

EL-2752

1/16

36 mm



Cardiovascular

Vascular Clamps

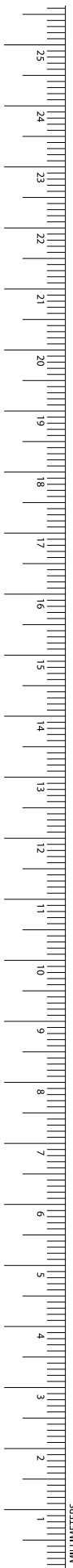

EL-2753-EL-2755

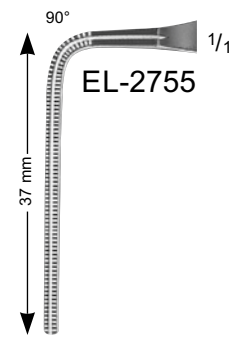
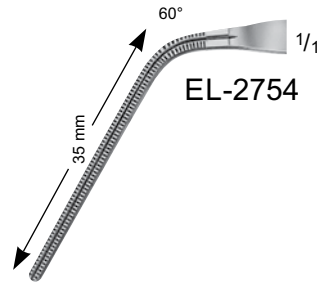
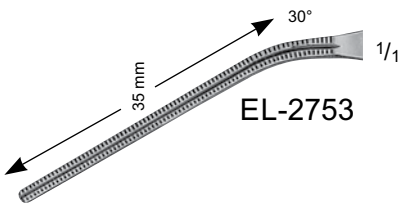

COOLEY Atraumatic Pediatric Multi-Purpose Clamp, Angled Shaft

Catalog Number	Jaw Angle	Jaw Length (mm)	Length (in.)
EL-2753	30°	35	6 1/2
EL-2754	60°	35	6 1/4
EL-2755	90°	37	6



EL-2756

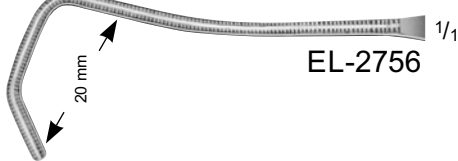
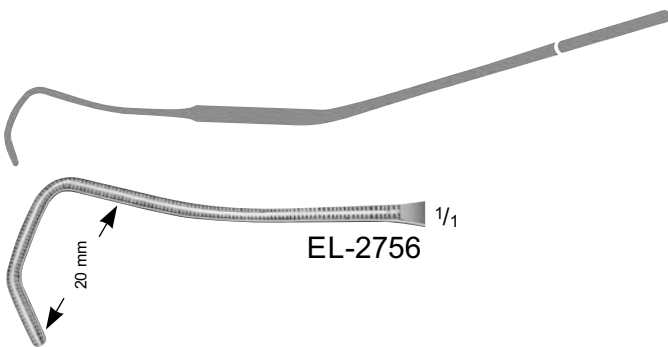

COOLEY Atraumatic Pediatric Anastomosis Clamp, Angled Shaft

Catalog Number	Jaw Length (mm)	Length (in.)
EL-2756	20	6 7/8

**COOLEY Atraumatic Renal Artery
Clamp, Angled Shaft**

Catalog Number	Jaw Length (mm)	Length (in.)
EL-2757	108	10 1/4

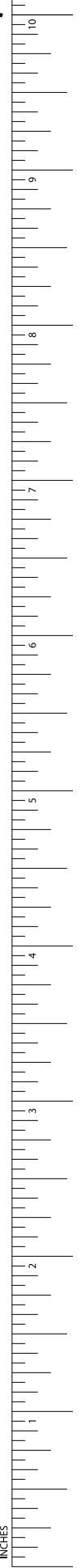
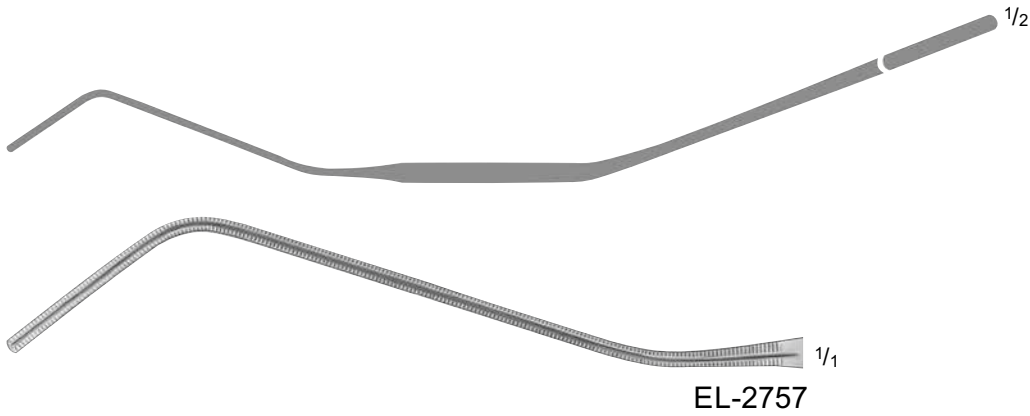
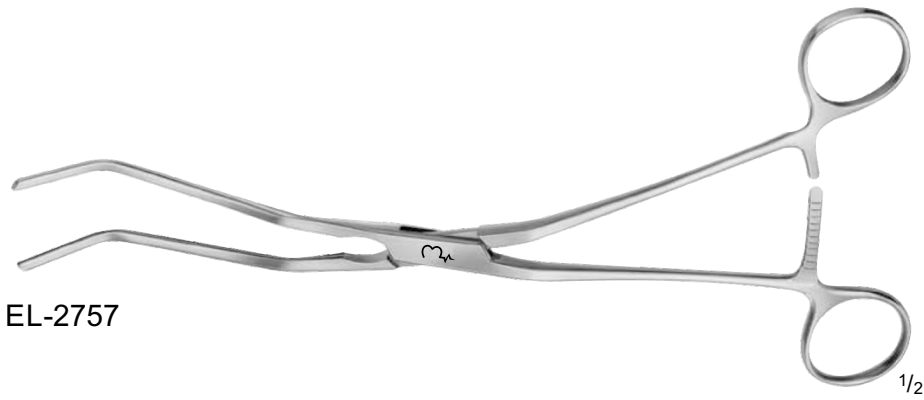

Cardiovascular
Vascular Clamps

**COOLEY Atraumatic Aorta Clamp,
Angled Shaft**

Catalog Number	Jaw Length (mm)	Length (in.)
EL-2758	73	10



EL-2758

1/2

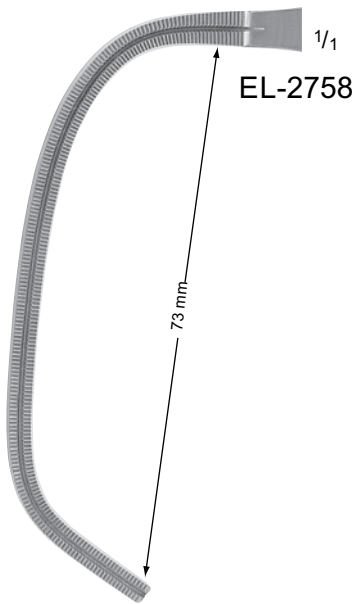

EL-2758

73 mm

1/1

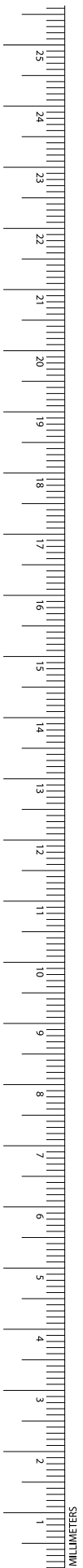

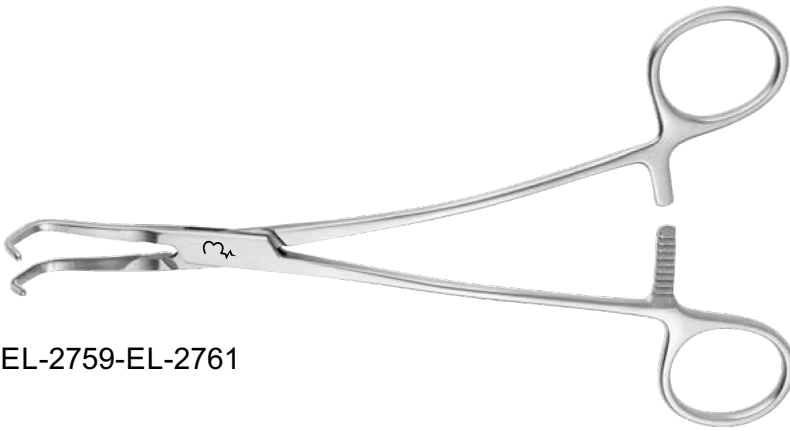

EL-2759-EL-2761



EL-2759



EL-2760



EL-2761

COOLEY Tangential Clamp, Calibrated

Catalog Number	Jaw (mm)	Length (in.)
EL-2759	20 x 7	7 3/4
EL-2760	25 x 8	7 7/8
EL-2761	38x 10	7 7/8

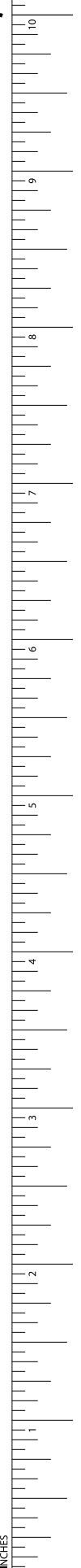

Cardiovascular
Vascular Clamps

COOLEY Atraumatic Forceps, S-Shaped

Catalog Number	Jaw Length (mm)	Length (in.)
EL-2762	115	12 1/2

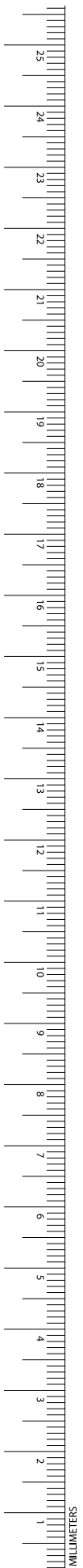
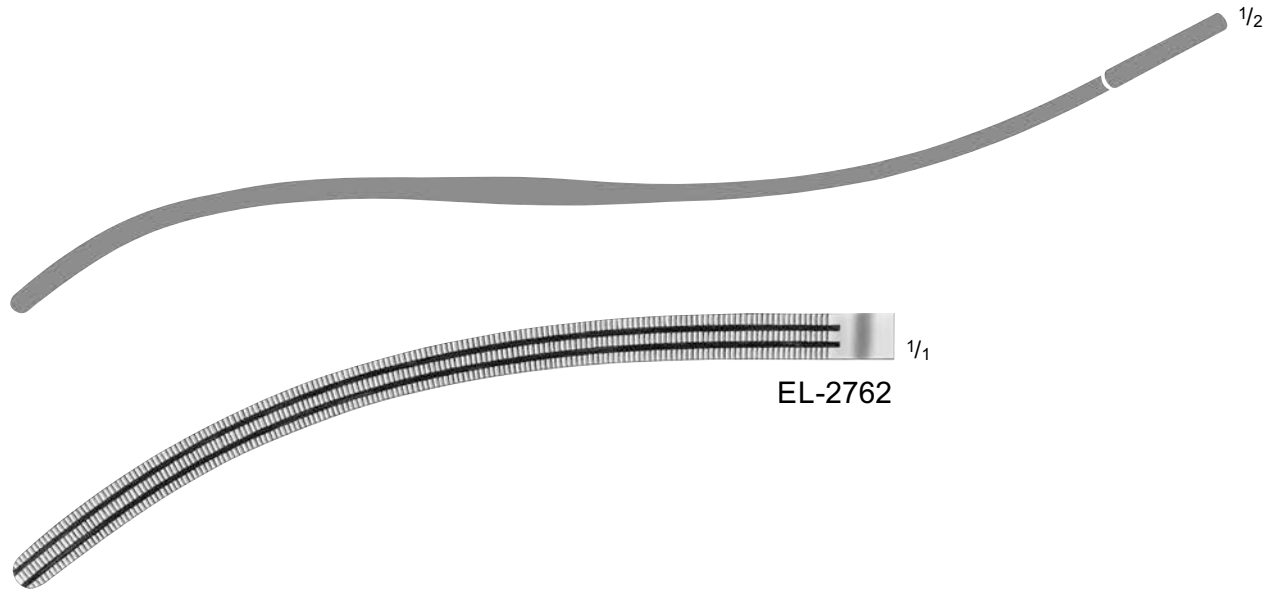

COOLEY Atraumatic Multi-Purpose Clamp, Curved, Angled Shaft, Calibrated

Catalog Number	Jaw Length (mm)	Length (in.)
EL-2763	32	8

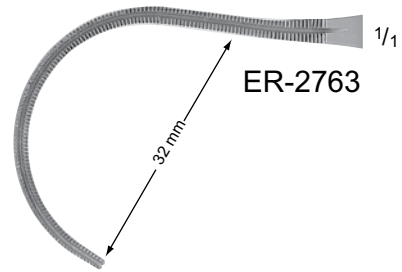

COOLEY Atraumatic Forceps, Curved, Angled Shaft

Catalog Number	Jaw Length (mm)	Length (in.)
EL-2764	82	11 1/4

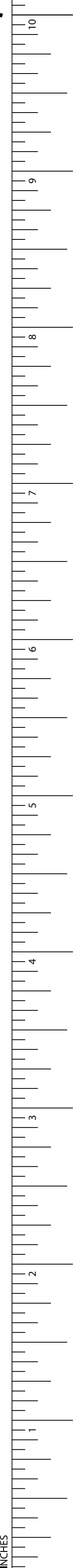
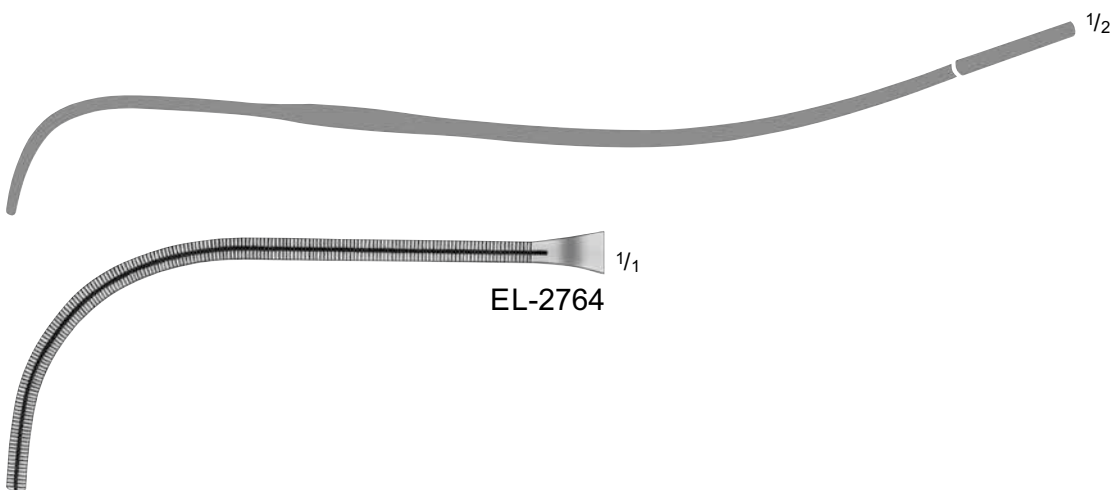

**Cardiovascular
Vascular Clamps**

PARRY-COOLEY Atraumatic Forceps

Catalog Number	Jaw Length (mm)	Length (in.)
EL-2765	70	11 5/8

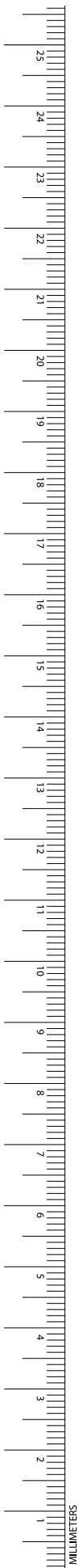
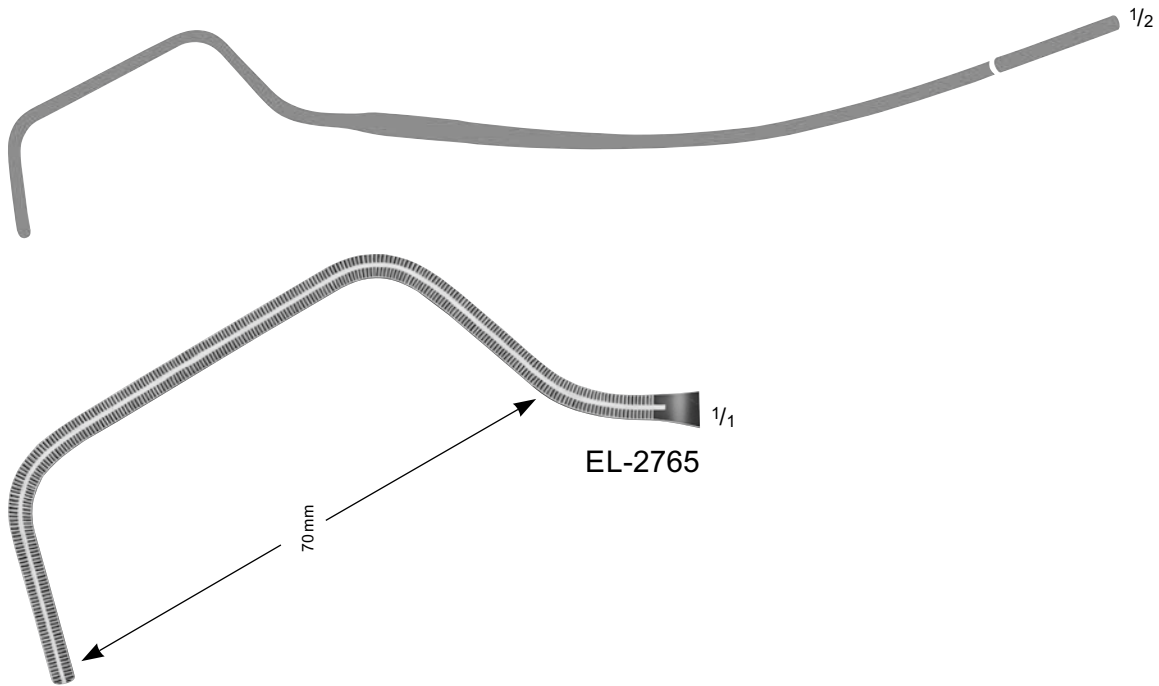

COOLEY Auricular Appendage Clamp

Catalog Number	Jaw	Length (in.)
EL-2766	40 x 10	10

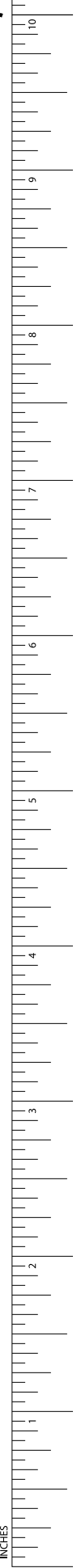
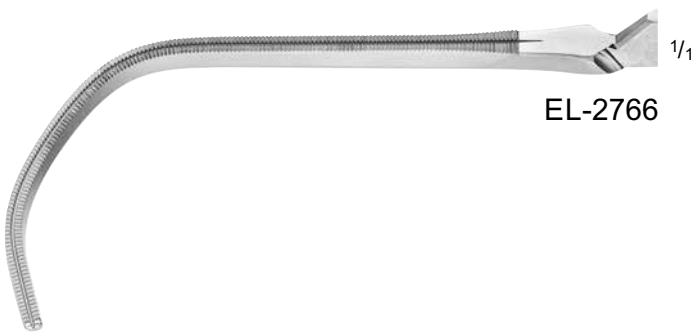

Cardiovascular Vascular Clamps

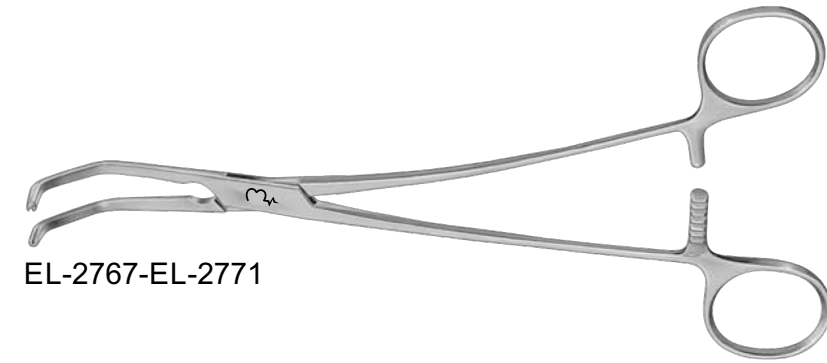
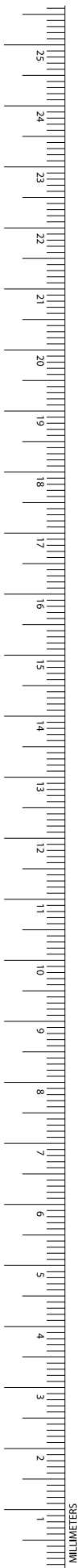

EL-2767-EL-2771

COOLEY Partial Occlusion Clamp

Catalog Number	Jaw Length (mm)	Length (in.)
EL-2767	31	8
EL-2768	44	10 1/4
EL-2769	50	10 1/2
EL-2770	63	10 1/2
EL-2771	78	10 3/4

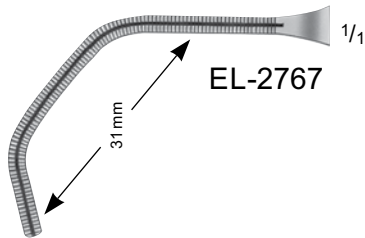

EL-2767

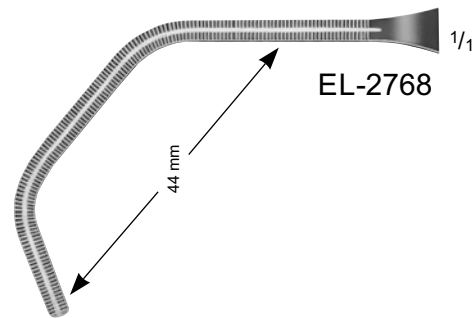

EL-2768

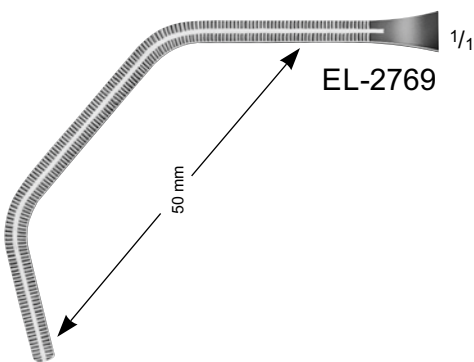

EL-2769

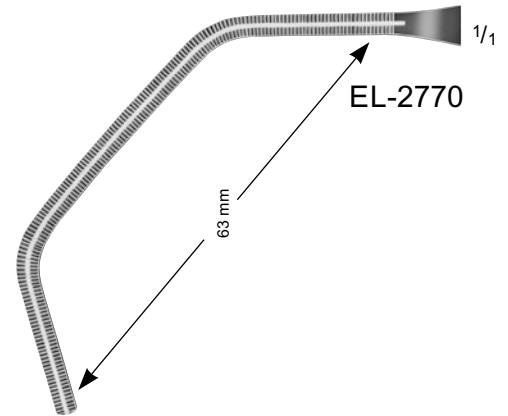

EL-2770

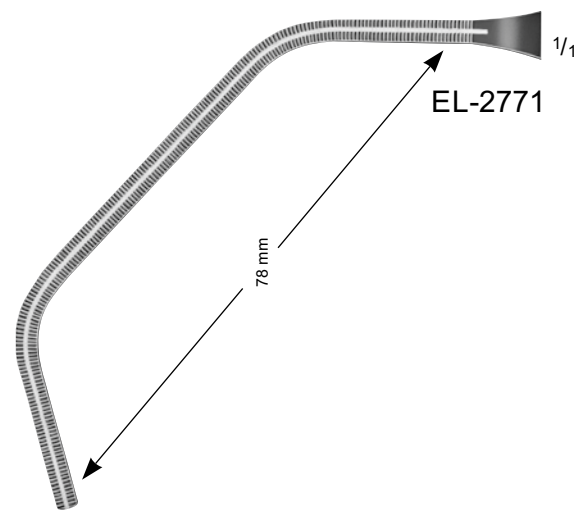

EL-2771

Atraumatic Multi-Purpose Clamp

Catalog Number	Jaw Length (mm)	Jaw	Length (in.)
EL-2772	50	STR	6 3/4
EL-2773	50	ANG 15°	6 3/4
EL-2774	50	ANG 30°	6 3/4
EL-2775	50	ANG 45°	6 1/4

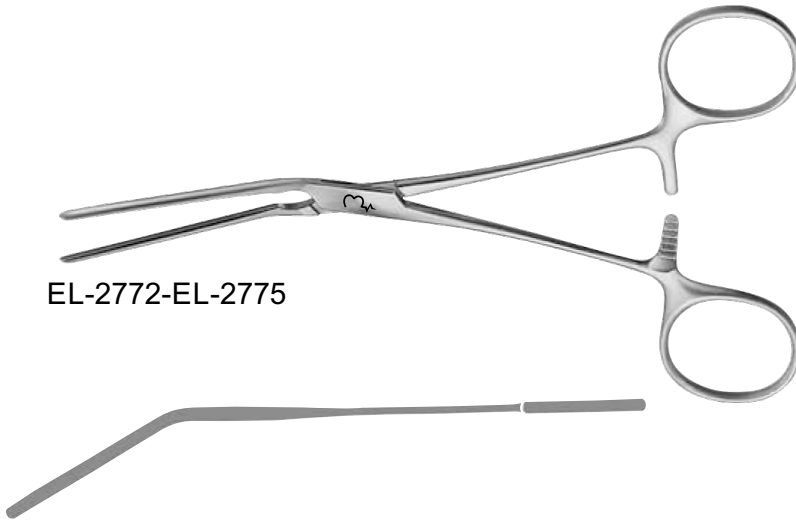

EL-2772-EL-2775

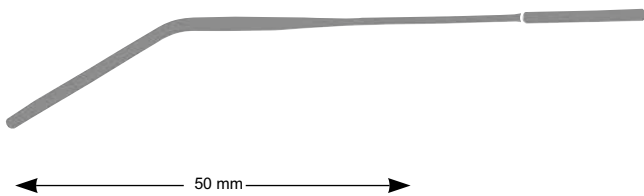

50 mm

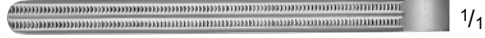

ER-2772

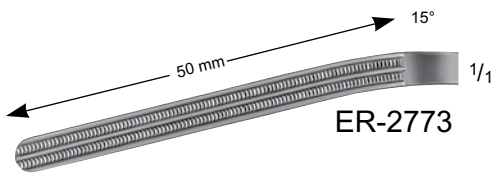

15°

50 mm

1/1

ER-2773

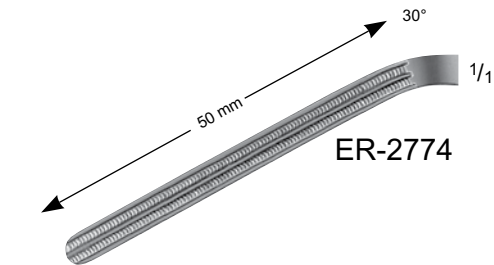

30°

50 mm

1/1

ER-2774

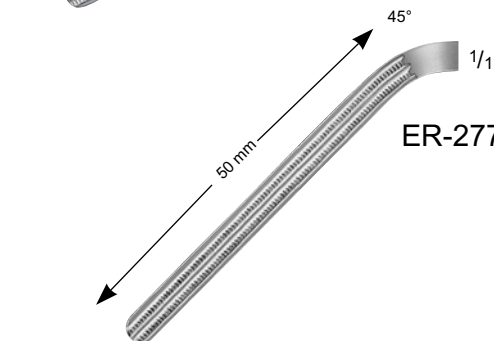

45°

50 mm

1/1

ER-2775

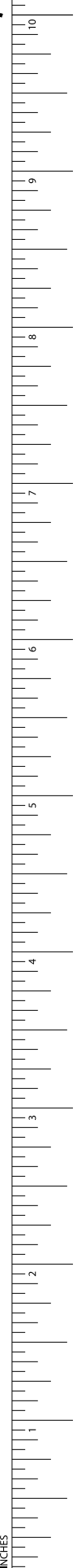

Cardiovascular
Vascular Clamps

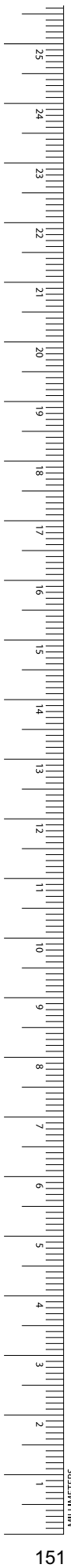

KLINTMALM Liver Transplant Clamp

Catalog Number	Jaw Length (mm)	Length (in.)
EL-2776	95	9 3/4

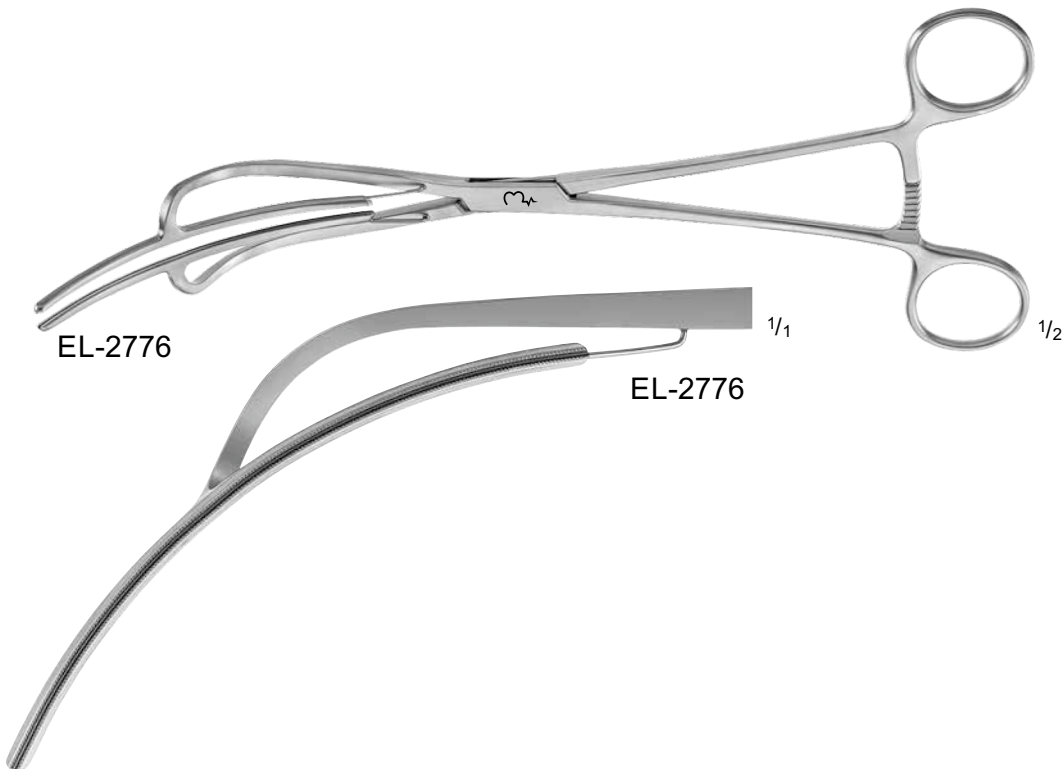

KITZMILLER Clamp

Catalog Number	Jaw	Jaw Length (mm)	Length (in.)
EL-2777	ANG LEFT	10	5 1/4
EL-2778	ANG RIGHT	10	5 1/4

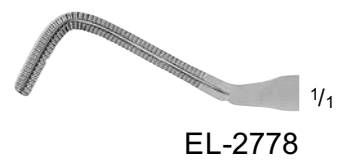
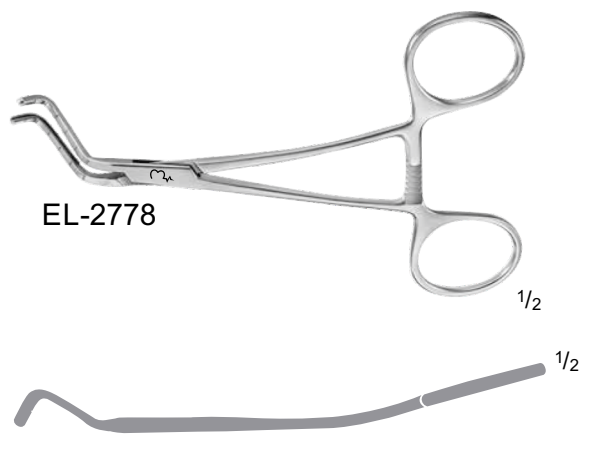
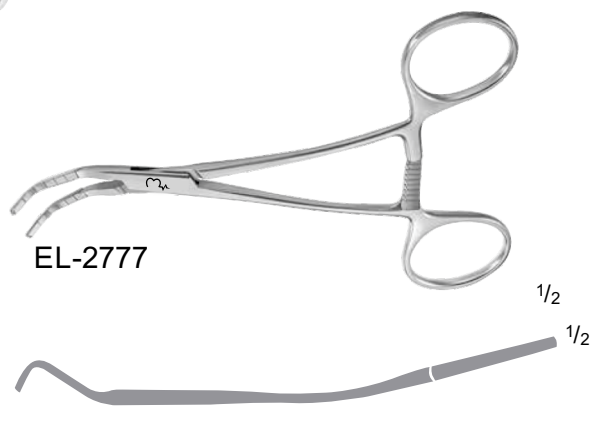

POTTS Liver Clamp W/ Teeth

Catalog Number	Size	Length (in.)
EL-2778	SMALL	10
EL-2779	MEDIUM	10 1/4
EL-2780	LARGE	10 5/8

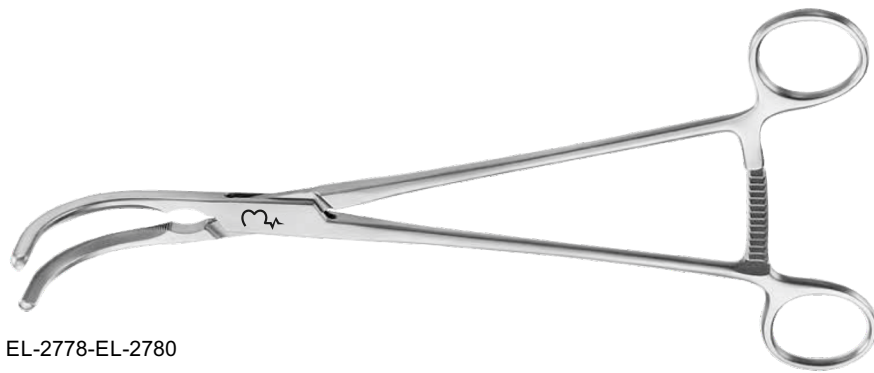

EL-2778-EL-2780

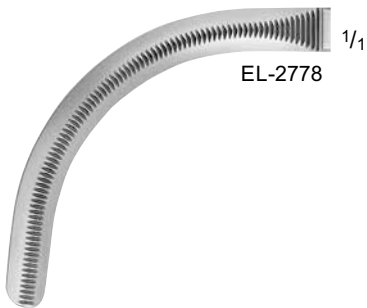

EL-2778

1/1

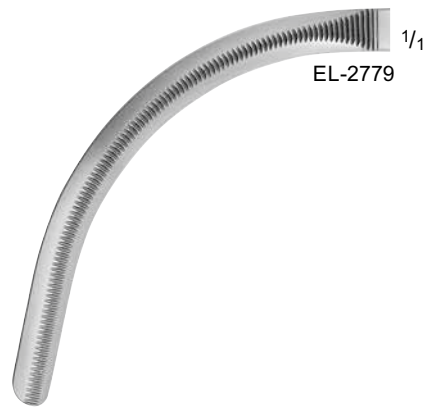

EL-2779

1/1

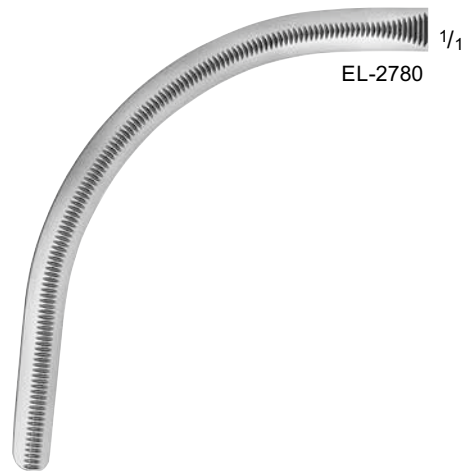

EL-2780

1/1

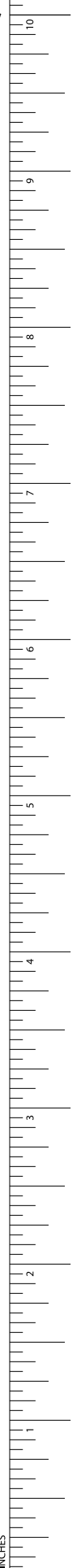

Cardiovascular
Vascular Clamps

PARSONNET Aorta Clamp

Catalog Number	Jaw Length (mm)	Length (in.)
EL-2781	28	9 3/8
EL-2782	32	9 5/8
EL-2783	38	9 5/8
EL-2784	45	10

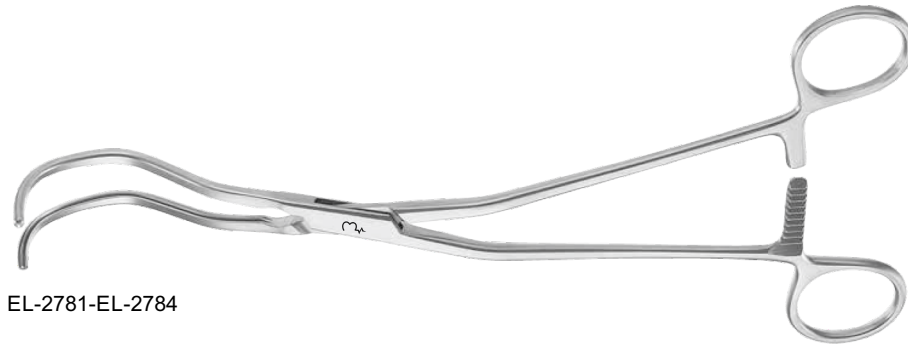

EL-2781-EL-2784



EL-2781

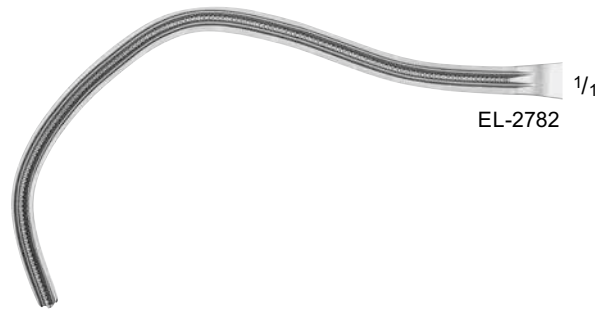

EL-2782

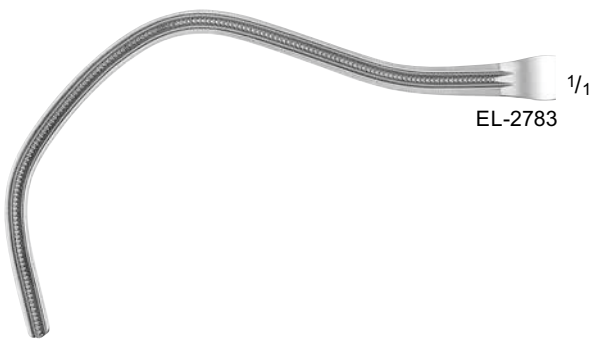

EL-2783

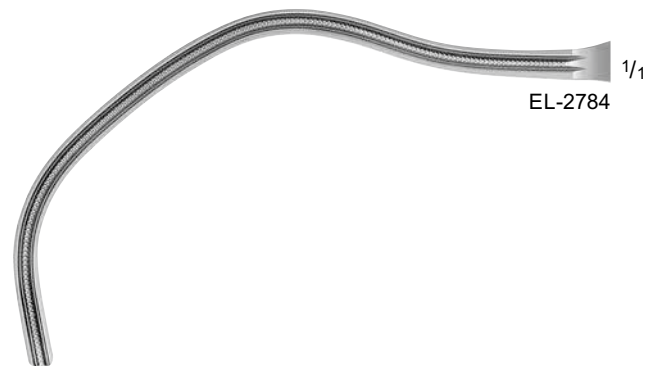

EL-2784

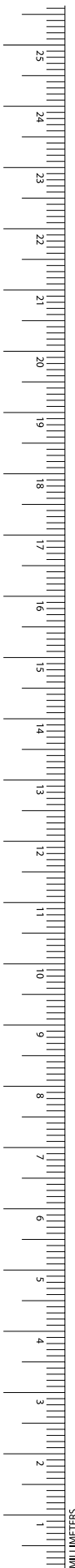



EL-2785-EL-2786



**JAVID Carotid Artery Bypass
Shunt Clamp**

Catalog Number	Jaw	Length (in.)
EL-2785	4 MM RING	6 5/8
EL-2786	6 MM RING	7

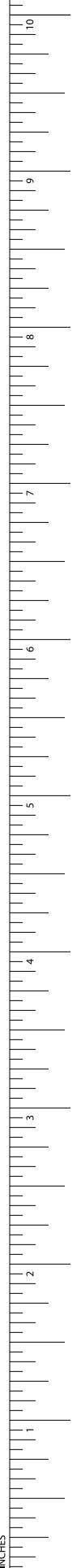

Cardiovascular

Bulldog and Micro Vessel Clamps

JOHNS-HOPKINS Apply/Remove Forceps

Catalog Number	Length (in.)
EL-2787	9 1/2

Forceps for applying and removing bulldog clamps



JOHNS-HOPKINS Bulldog Clamp

Catalog Number	Jaw	Jaw Length (mm)	Length (in.)
EL-2788	CVD	12	1 1/2
EL-2789	CVD	17	1 7/8
EL-2790	CVD	25	2 1/8
EL-2791	CVD	30	2 1/2
EL-2792	CVD	33	2 3/4
EL-2793	CVD	42	3 1/8
EL-2794	CVD	52	3 1/2



DIEFFENBACH Bulldog Clamp

Catalog Number	Jaw	Jaw Length (mm)	Length (in.)
EL-2795	STR	12	1 1/2
EL-2796	STR	16	1 7/8
EL-2797	STR	16	2 1/8
EL-2798	CVD	12	1 1/2
EL-2799	CVD	16	1 7/8
EL-2800	CVD	16	2 1/8

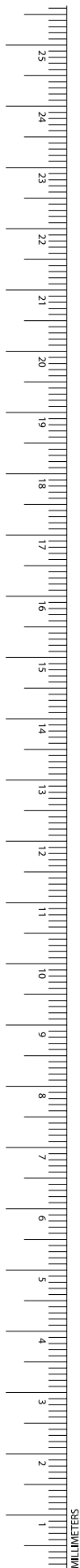



EL-2801



EL-2802



EL-2803



EL-2804



EL-2805



EL-2806



EL-2807



EL-2808

Bulldog Clamp, Lightweight

Catalog Number	Jaw	Jaw Length (mm)	Length (in.)
EL-2801	STR	18	1 1/2
EL-2802	ANG	18	1 3/8
EL-2803	ANG	21	1 1/2

DEBAKEY-HESS Bulldog Clamp

Catalog Number	Jaw	Jaw Length (mm)	Length (in.)
EL-2804	ANG	20	1 3/8
EL-2805	ANG	30	1 1/2

GREGORY-DEBAKEY Bulldog Clamp

Catalog Number	Jaw	Jaw Length (mm)	Length (in.)
EL-2806	ANG	70	4 3/4

GREGORY Mini-Bulldog Clamp

Catalog Number	Jaw Length (mm)	Jaw	Length (in.)
EL-2807	50	ANG	4 1/8
EL-2808	65	ANG	4 3/4

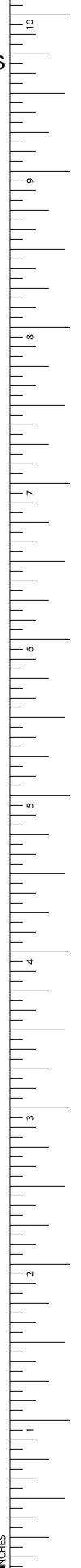

Cardiovascular

Bulldog and Micro Vessel Clamps

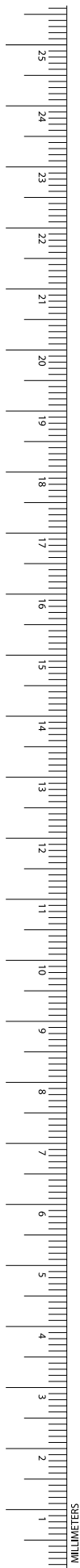

GREGORY Mini-Bulldog Clamp

Catalog Number	Jaw	Jaw Length (mm)	Length (in.)
EL-2809	CVD-LEFT	70	4 3/4
EL-2810	CVD-RIGHT	70	4 3/4

1/1

EL-2809-EL-2810

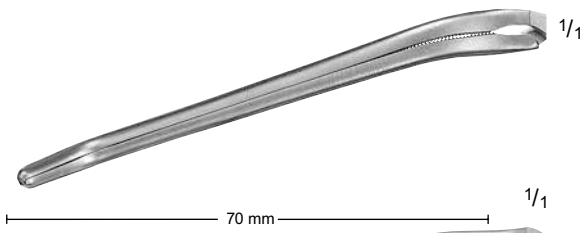

EL-2809



EL-2810



EL-2811-EL-2814



EL-2815-EL-2818



EL-2819

1/1



EL-2820

1/1



EL-2821

1/1



EL-2822

1/1



10 mm
EL-2823

1/1



13 mm
EL-2824

1/1



10 mm
EL-2825

1/1



13 mm
EL-2826

1/1

DEBAKEY Atraumatic Mini-Bulldog Clamp

Catalog Number	Jaw	Jaw Length (mm)	Length (in.)
EL-2811	STR	20	3 1/8
EL-2812	STR	30	3 1/2
EL-2813	STR	45	4 1/8
EL-2814	STR	65	5
EL-2815	CVD	20	3 1/8
EL-2816	CVD	30	3 1/4
EL-2817	CVD	45	3 3/4
EL-2818	CVD	65	4 1/2

Atraumatic Mini-Bulldog Clamp

Catalog Number	Jaw	Jaw Length (mm)	Length (in.)
EL-2819	STR	14	1 3/8
EL-2820	STR	19	1 3/4
EL-2821	CVD	14	1 3/8
EL-2822	CVD	19	1 3/4

DIETHRICH Micro Bulldog Clamp

Catalog Number	Jaw	Jaw Length (mm)	Length (in.)
EL-2823	STR	16	2
EL-2824	STR	20	2 1/4
EL-2825	ANG	10	1 7/8
EL-2826	ANG	13	1 7/8

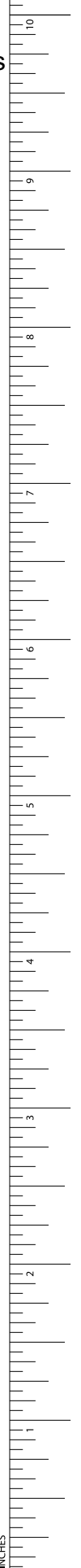

Cardiovascular

Bulldog and Micro Vessel Clamps

DEBAKEY Atraumatic Mini-Bulldog Clamp

Catalog Number	Jaw Angle	Jaw Length (mm)	Length (in.)
EL-2827	STR	20	2
EL-2828	CVD	20	1 7/8
EL-2829	MULTI	21	3
EL-2830	MULTI	42	4
EL-2831	S-SHAPED	38	3 3/4

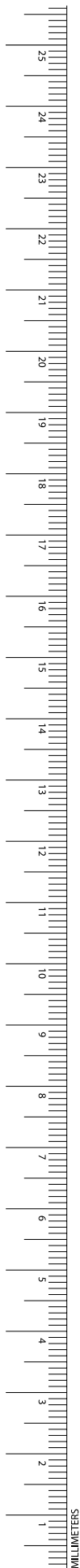
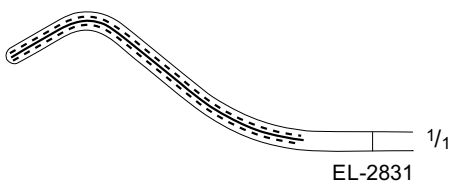
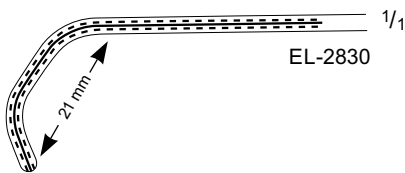
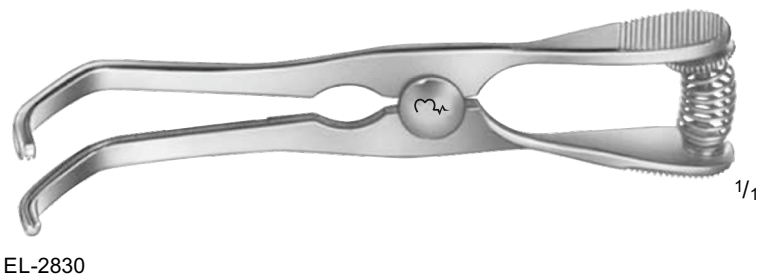
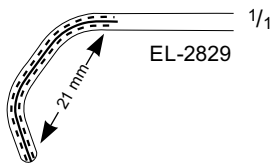
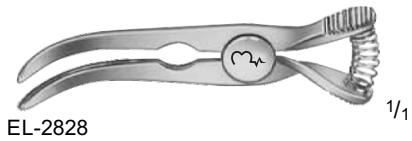



EL-2832



EL-2833-EL-2834-EL-2835



EL-2836-EL-2837-EL-2838



EL-2839-EL-2842



EL-2843-EL-2846

GLOVER Atraumatic Mini-Bulldog Clamp

Catalog Number	Jaw Angle	Jaw Length (mm)	Length (in.)
EL-2832	75°	20	2
EL-2833	STR	25	2 3/4
EL-2834	STR	40	3 3/4
EL-2835	STR	60	4 1/2
EL-2836	CVD	25	2 1/2
EL-2837	CVD	40	3 1/2
EL-2838	CVD	60	4 1/4

COOLEY Atraumatic Bulldog Clamp

Catalog Number	Jaw	Jaw Length (mm)	Length (in.)
EL-2839	STR	20	2
EL-2840	STR	30	2 1/2
EL-2841	STR	45	3 1/4
EL-2842	STR	60	5
EL-2843	CVD	44	1 3/4
EL-2844	CVD	64	2 1/2
EL-2845	CVD	75	3 1/8
EL-2846	CVD	60	4 3/4



Cardiovascular

Bulldog and Micro Vessel Clamps



GLOVER Atraumatic Bulldog Clamp

Catalog Number	Jaw	Jaw Length (mm)	Length (in.)
EL-2847	STR	25	2
EL-2848	CVD	20	1 1/2
EL-2849	CVD	30	2 3/8
EL-2850	CVD	45	3
EL-2851	CVD	55	4 3/4



SCHWARTZ Apply/Remove Forceps

Catalog Number	Length (in.)
EL-2852	7 1/2



SCHWARTZ Micro-Vessel Clamp, Cross-Serrated

Catalog Number	Jaw	Jaw Length (mm)	Closing Force	Length (in.)
EL-2853	STR	8	400G	1
EL-2854	25°	8	400G	1
EL-2855	45°	8	400G	1

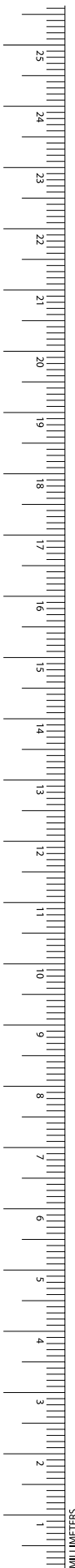



EL-2856-EL-2857



EL-2856-EL-2857



EL-2858-EL-2859

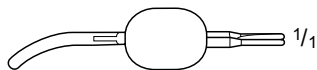

EL-2858-EL-2859



EL-2860-EL-2861

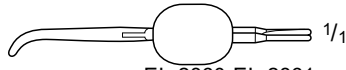

EL-2860-EL-2861



EL-2862-EL-2863

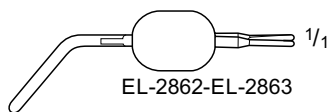

EL-2862-EL-2863



EL-2864-EL-2865

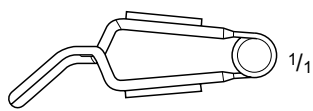

EL-2864-EL-2865



EL-2866

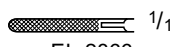

EL-2866

MUELLER Atraumatic Micro-Vessel Clamp

Catalog Number	Jaw	Closing Force
EL-2856	STR	50G
EL-2857	STR	80G
EL-2858	FULL-CVD	50G
EL-2859	FULL-CVD	80G
EL-2860	CVD-TIP	50G
EL-2861	CVD-TIP	80G
EL-2862	ANG	50G
EL-2863	ANG	80G
EL-2864	LAT-ANG	50G
EL-2865	LAT-ANG	80G

MUELLER Ligature Forceps

Catalog Number	Jaw
EL-2866	STR

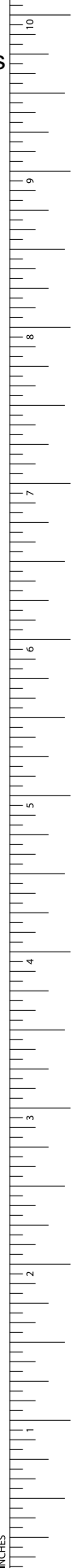

Cardiovascular

Bulldog and Micro Vessel Clamps

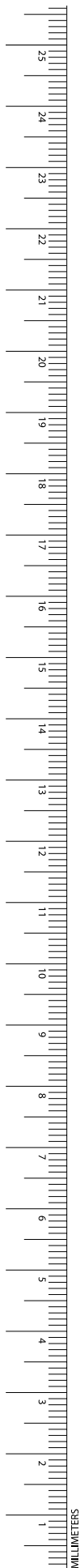

MUELLER Alpha Vessel Clamp

Catalog Number	Jaw	Closing Force
EL-2867	SLIGHT-CVD	250G
EL-2868	SLIGHT-CVD	350G
EL-2869	CVD	250G
EL-2870	CVD	350G
EL-2871	ANG	250G
EL-2872	ANG	350G
EL-2873	KNEE-BENT	250G
EL-2874	KNEE-BENT	350G



NABATOFF Vein Stripper Set

Catalog Number	Description
EL-2875	METAL CASE
EL-2876	HANDLE
EL-2877	PLASTIC PROBE TIP
EL-2878	METAL PROBE TIP, 3 MM
EL-2879	METAL OLIVE, 6 MM
EL-2880	METAL OLIVE, 9 MM
EL-2881	METAL OLIVE, 12 MM
EL-2882	METAL OLIVE, 15 MM



NABATOFF Mini Vein Stripper Set

Catalog Number	Description
EL-2883	METAL CASE
EL-2884	METAL OLIVE, 3 MM
EL-2885	METAL OLIVE, 4 MM
EL-2886	METAL OLIVE, 5 MM

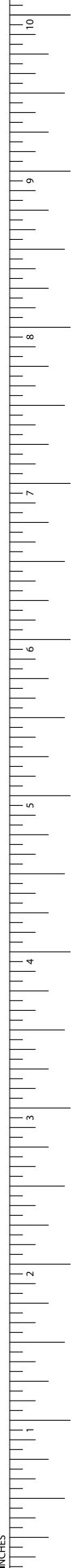
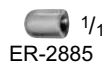

Cardiovascular
Vessel Instruments

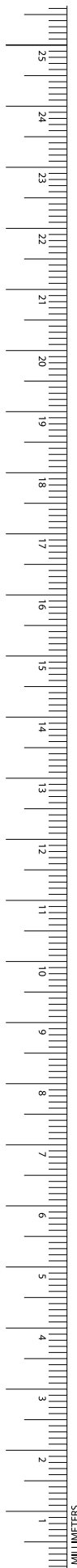

VARADY Varix Dissector, Double Ended

Catalog Number	Tip Size (mm)	Length (in.)
EL-2887	0.30 / 0.30	7



VARADY Varix Extractor, Double Ended W/ Hook

Catalog Number	Tip Size (mm)	Length (in.)
EL-2888	0.25 / 0.40	6 3/4
EL-2889	0.75 / 0.60	7
EL-2890	0.75 / 1.2	7



VARADY Mini-Varix Extractor, Double Ended W/ Hook

Catalog Number	Tip Size (mm)	Length (in.)
EL-2891	0.35 / 0.50	6 3/4



VARADY Micro Spatula, Double Ended

Catalog Number	Tip Size (mm)	Length (in.)
EL-2892	0.35 / 0.25	6 7/8



EL-2893-EL-2902

Endarterectomy Stripper

Catalog Number	Tip Size (mm)	Length (in.)
EL-2893	2	21 3/4
EL-2894	3	21 3/4
EL-2895	4	21 3/4
EL-2896	6	21 3/4
EL-2897	7	21 3/4
EL-2898	8.5	21 3/4
EL-2899	10	21 3/4
EL-2900	12	21 3/4
EL-2901	14	21 3/4
EL-2902	-	4 1/4

○ 1/1
EL-2893

○ 1/1
EL-2894

○ 1/1
EL-2895

○ 1/1
EL-2896

○ 1/1
EL-2897

○ 1/1
EL-2898

○ 1/1
EL-2899

○ 1/1
EL-2900

○ 1/1
EL-2901

EL-2902 1/2

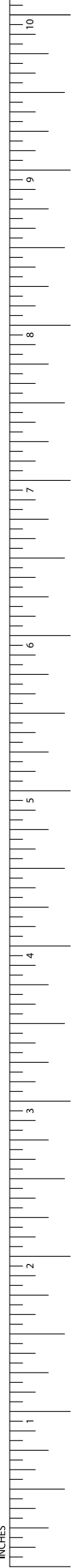

Cardiovascular

Specialty CV/Thoracic Instruments

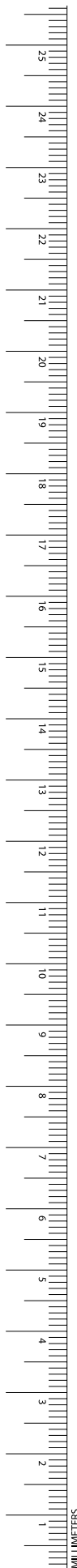

EL-2903-EL-2904



EL-2903-EL-2904



EL-2905

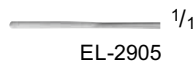

EL-2905



EL-2908-EL-2922

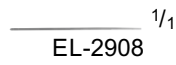

EL-2908

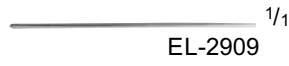

EL-2909



EL-2910



EL-2911



EL-2912



EL-2913



EL-2914



EL-2915



EL-2916



EL-2917



EL-2918



EL-2919



EL-2919



EL-2920



EL-2921



EL-2921



EL-2922



EL-2922

Vascular Spatula, Blunt, 3 mm

Catalog Number	Length (in.)
EL-2903	7 1/4
EL-2904	8 1/2

JACOBSON Endarterectomy Spatula

Catalog Number	Length (in.)
EL-2905	7

DEBAKEY Vascular Dilator, Malleable

Catalog Number	Tip Size (mm)	Length (in.)
EL-2906	SET OF 12	-
EL-2907	SET OF 5	-
EL-2908	0.5	7 1/2
EL-2909	1.0	7 1/2
EL-2910	1.5	7 1/2
EL-2911	2.0	7 1/2
EL-2912	2.5	7 1/2
EL-2913	3.0	7 1/2
EL-2914	3.5	7 1/2
EL-2915	4.0	7 1/2
EL-2916	4.5	7 1/2
EL-2917	5.0	7 1/2
EL-2918	6.0	7 1/2
EL-2919	7.0	7 1/2
EL-2920	8.0	7 1/2
EL-2921	9.0	7 1/2
EL-2922	10.0	7 1/2

EL-2924-EL-2932 1/2

EL-2924 1/1

EL-2925 1/1

EL-2926 1/1

EL-2927 1/1

EL-2928 1/1

EL-2929 1/1

EL-2930 1/1

EL-2931 1/1

EL-2932 1/1

EL-2933 1/2

GARRETT Vascular Dilator

Catalog Number	Tip Size (mm)	Length (in.)
EL-2923	COMPLETE SET	5 1/2
EL-2924	1.0	5 1/2
EL-2925	1.5	5 1/2
EL-2926	2.0	5 1/2
EL-2927	2.5	5 1/2
EL-2928	3.0	5 1/2
EL-2929	3.5	5 1/2
EL-2930	4.0	5 1/2
EL-2931	4.5	5 1/2
EL-2932	5.0	5 1/2
EL-2933	TUBE	5 1/2

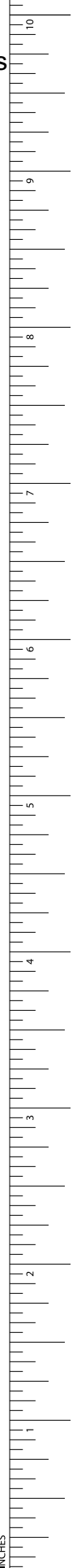

Cardiovascular

Specialty CV/Thoracic Instruments

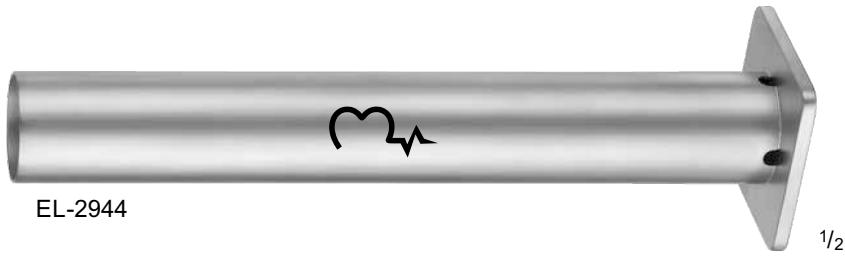
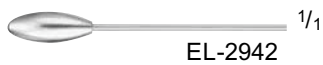
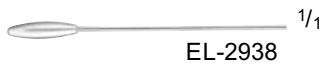
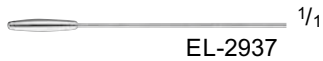
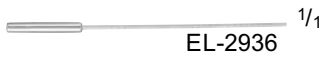
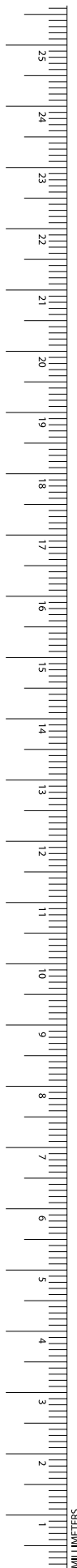

GARRETT Vascular Dilator

Catalog Number	Tip Size (mm)	Length (in.)
EL-2934	COMPLETE SET	8 1/2
EL-2935	1.0	8 1/2
EL-2936	1.5	8 1/2
EL-2937	2.0	8 1/2
EL-2938	2.5	8 1/2
EL-2939	3.0	8 1/2
EL-2940	3.5	8 1/2
EL-2941	4.0	8 1/2
EL-2942	4.5	8 1/2
EL-2943	5.0	8 1/2
EL-2944	TUBE	8 1/2

Aortic Arch Dilator

Catalog Number	Tip Size (mm)	Length (in.)
EL-2945	5	8
EL-2946	6	8
EL-2947	8	8
EL-2948	9.5	8



EL-2949-EL-2952



EL-2949



EL-2950



EL-2951



EL-2952



ER-2953-ER-2954



EL-2955



EL-2956



EL-2957

SCHMID Vessel Irrigation Cannula, Silver Plated

Catalog Number	Tip Size (mm)	Length (in.)
EL-2949	3	6
EL-2950	4	6
EL-2951	5	6
EL-2952	6	6

Heparin Needle

Catalog Number	Gauge	Length (in.)
EL-2953	13	3 1/2
EL-2954	18	3 3/4

ZANGER Heparin Cannula, Malleable

Catalog Number	Tip Size (mm)	Length (in.)
EL-2955	3.5	2 3/4

IMA Heparin Cannula, Malleable

Catalog Number	Tip Size (mm)	Length (in.)
EL-2956	1.5	2 1/8

Luer Lock Adapter

Catalog Number	Length (in.)
EL-2957	1 1/2

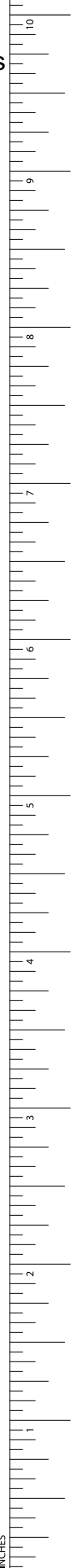

Cardiovascular

Specialty CV/Thoracic Instruments

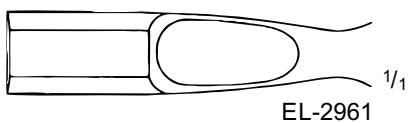
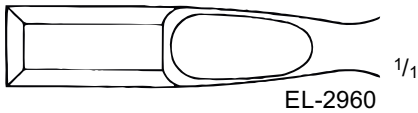
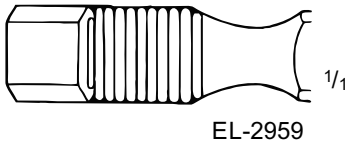
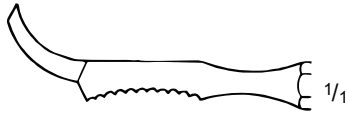
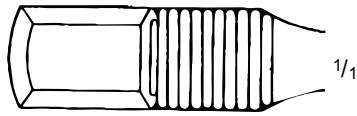
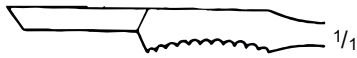
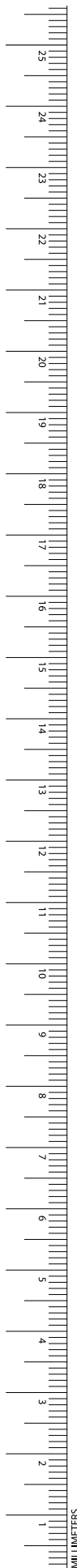

FARABEUF Elevator

Catalog Number	Tip Size (mm)	Blade Shape	Length (in.)
EL-2958	12.5	STR	5 3/4
EL-2959	12.5	CVD	5 1/4

FARABEUF-COLLIN Elevator

Catalog Number	Tip Size (mm)	Blade Shape	Length (in.)
EL-2960	11	STR	6 1/4
EL-2961	11	CVD	6 1/4



EL-2962

MATSON Rib Stripper/Elevator

Catalog Number	Length (in.)
EL-2962	8 3/4



EL-2963-EL-2967

LAMBOTTE Rib Elevator

Catalog Number	Tip Size (mm)	Length (in.)
EL-2963	5	8 1/2
EL-2964	10	8 1/2
EL-2965	15	8 1/2
EL-2966	20	8 1/2
EL-2967	25	8 1/2



1/1



1/1

EL-2963-EL-2967

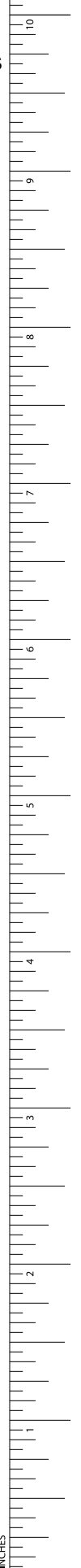

Cardiovascular

Specialty CV/Thoracic Instruments

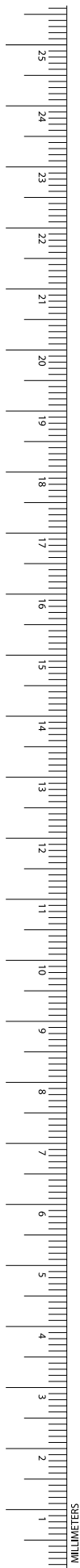

EL-2968-EL-2972

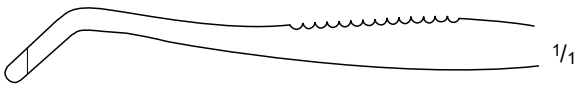

EL-2968

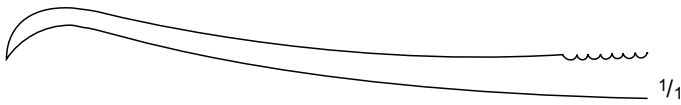

EL-2969



EL-2970



EL-2971



EL-2972

SEMB Elevator

Catalog Number	Tip Size (mm)	Length (in.)
EL-2968	12	7 1/2
EL-2969	12	9
EL-2970	13	9
EL-2971	13	9
EL-2972	15	9

DOYEN Elevator

Catalog Number	Blade End	Blade Shape	Length (in.)
EL-2973	PEDIATRIC	LEFT-CVD	6 7/8
EL-2974	ADULT	LEFT-CVD	6 7/8
EL-2975	PEDIATRIC	RIGHT-CVD	6 7/8
EL-2976	ADULT	RIGHT-CVD	6 7/8
EL-2977	-	LEFT-CVD	9 1/2
EL-2978	-	RIGHT-CVD	9 1/2



EL-2973-EL-2974

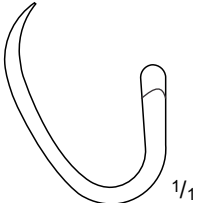

EL-2973

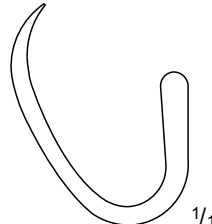

EL-2974



EL-2975-EL-2976

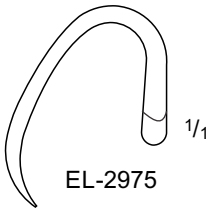

EL-2975

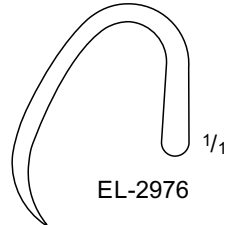

EL-2976



EL-2977

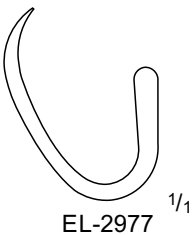

EL-2977



EL-2978

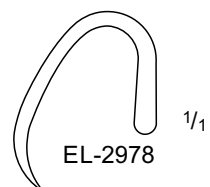

EL-2978



Cardiovascular

Specialty CV/Thoracic Instruments

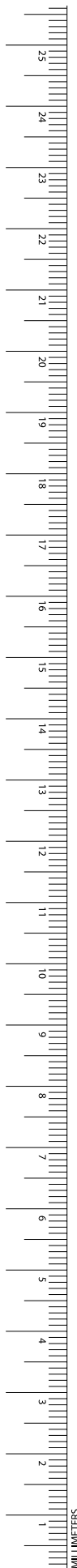

EL-2979

1/2



1/1

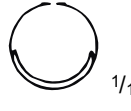

1/1

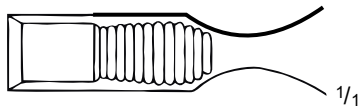

1/1

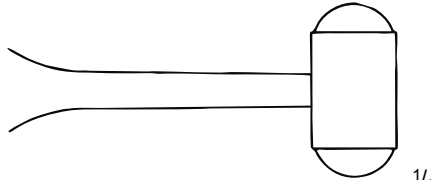

1/1

EL-2979

ALEXANDER Elevator

Catalog Number	Tip Size (mm)	Length (in.)
EL-2979	12	8 1/4



EL-2980

1/2

Rib Shears

Catalog Number	Blade	Length (in.)
EL-2980	S/B	9



EL-2981

1/2

GLUCK Rib Shears

Catalog Number	Length (in.)
EL-2981	7 1/2



EL-2982

1/3

BETHUNE Rib Shears

Catalog Number	Length (in.)
EL-2982	13 3/8



ER-2983-ER-2984

SAUERBRUCH Rib Shears

Catalog Number	Size	Length (in.)
EL-2983	PEDIATRIC	9 1/2
EL-2984	ADULT	10 5/8



EL-2985

GIERTZ-STILLE Rib Shears

Catalog Number	Length (in.)
EL-2985	9 3/4



EL-2986

SWEET Sternum Punch

Catalog Number	Length (in.)
EL-2986	10

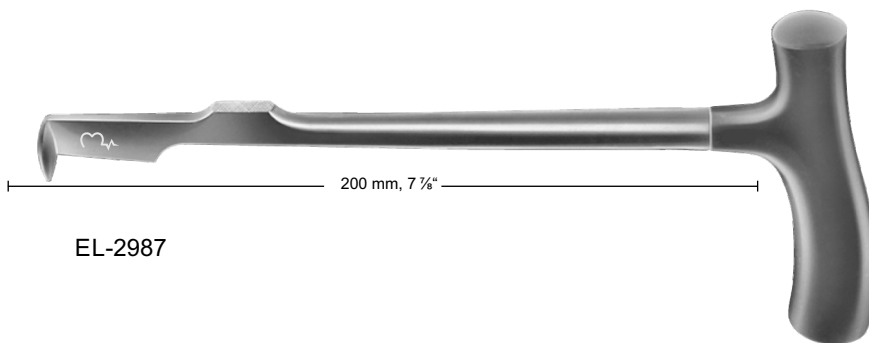

EL-2987

200 mm, 7 7/8"

LEBSCHE Sternum Chisel

Catalog Number	Length (in.)
EL-2987	9 3/4

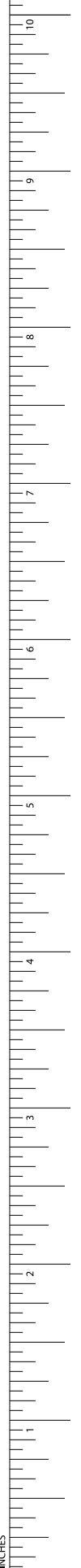

Cardiovascular

Specialty CV/Thoracic Instruments

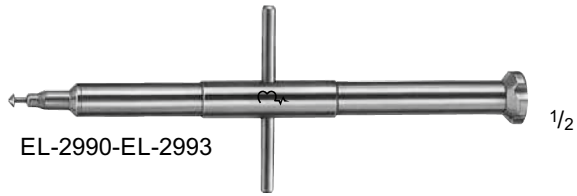
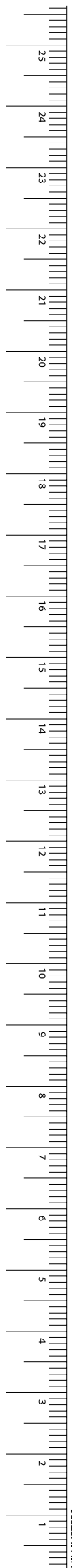

Aorta Punch

Catalog Number	Tip Size (mm)	Length (in.)
EL-2988	3.0	5 1/2
EL-2989	3.5	5 1/2
EL-2990	4.0	5 1/2
EL-2991	4.5	5 1/2
EL-2992	5.0	5 1/2
EL-2993	5.5	5 1/2
EL-2994	6.0	5 1/2

Valvulotome

Catalog Number	Tip	Length (in.)
EL-2995	ANTEGRADE	6 3/8
EL-2996	RETROGRADE	9 1/2
EL-2997		12 1/4



JENKNER Tunnelling Instruments

Catalog Number	Diameter (mm)	Description	Length (in.)
EL-2998	12	TUNNELLING TUBE W/ CONICAL TIP	16
EL-2999	12	TUNNELLING TUBE W/ CONICAL TIP	20
EL-3000	14	TUNNELLING TUBE W/ CONICAL TIP	16
EL-3001	14	TUNNELLING TUBE W/ CONICAL TIP	20
EL-3002	5	TUNNELLING FORCEPS F/ FC004R/ FC014R	16
EL-3003	5	TUNNELLING FORCEPS F/ FC005R/ FC015R	20
EL-3004	-	HANDLE F/ TUNNELLING TUBES	-

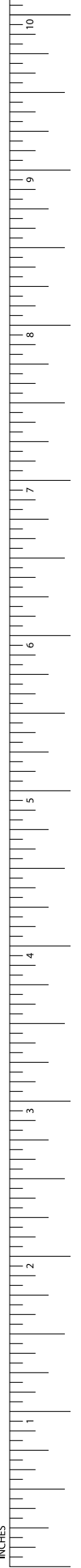
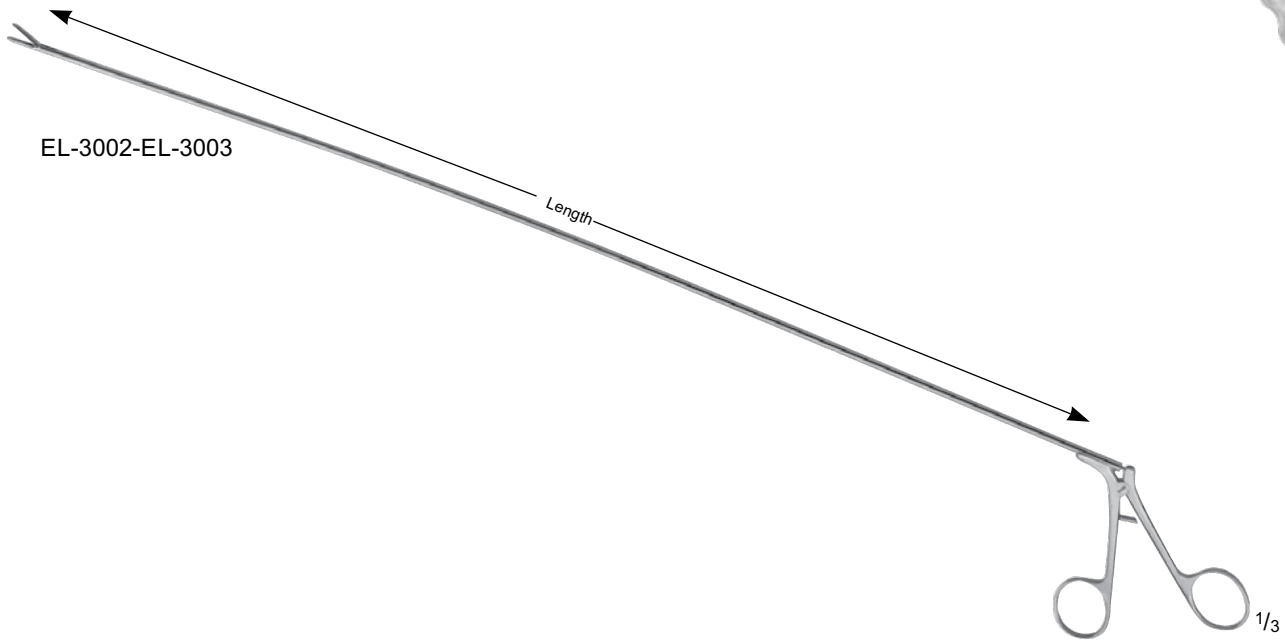
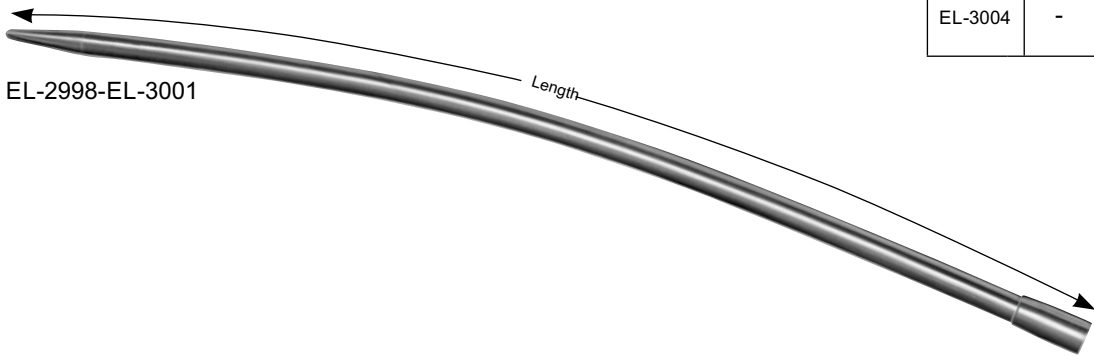

Cardiovascular

Specialty CV/Thoracic Instruments

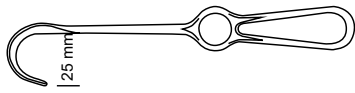
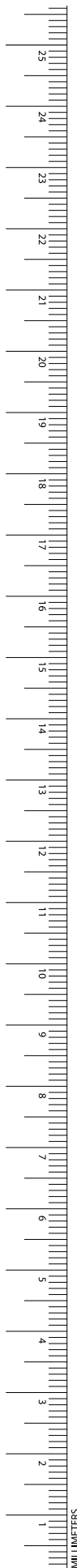

Dimensions for blade size of retractors
 1st number = depth Example: 25 x 38 mm
 2nd number = width



EL-3005-EL-3006

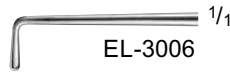

CUSHING Vessel Hook

Catalog Number	Tip Size (mm)	Tip	Length (in.)
EL-3005	1 x 4	BLUNT	7 1/2
EL-3006	1 x 7	BLUNT	7 1/2
EL-3007	1 x 6	BLUNT	11



EL-3007



EL-3008



CRILE Vessel Hook

Catalog Number	Tip Size (mm)	Tip	Length (in.)
EL-3008	1.5 x 9	BLUNT	7 7/8



EL-3009



DANDY Nerve Hook

Catalog Number	Tip Size (mm)	Tip	Length (in.)
EL-3009	1 x 8	BLUNT	8 3/4

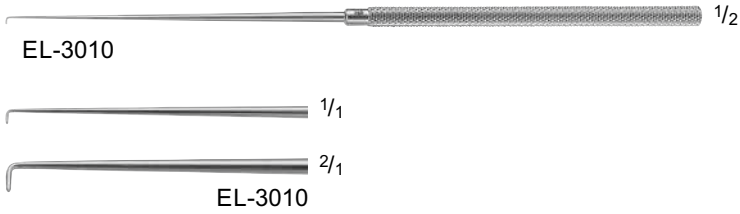

Blunt Hook

Catalog Number	Tip Size (mm)	Tip	Length (in.)
EL-3010	2	RND	7

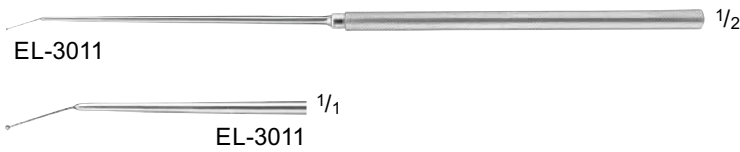

JACOBSON Probe

Catalog Number	Tip	Length (in.)
EL-3011	ANG, SINGLEPROBE	7 1/4
EL-3012	STR, DOUBLEPROBE	7 1/4

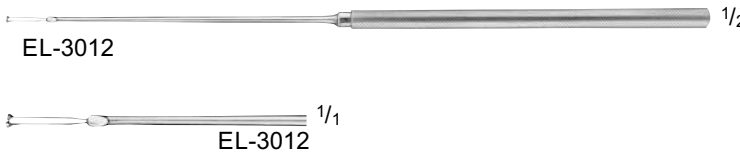

BREWSTER Retractor

Catalog Number	Blade Size (mm)	Blade	Length (in.)
EL-3013	25 x 45	CVD CONVEX	9

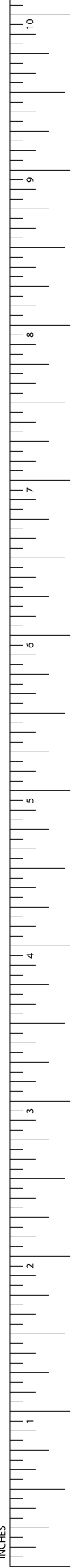

Cardiovascular Retractors

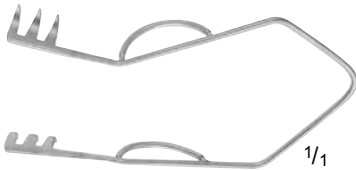

EL-3014

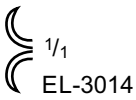

EL-3014



ER-3015-ER-3018



EL-3019-EL-3024



EL-3019



EL-3020



EL-3021

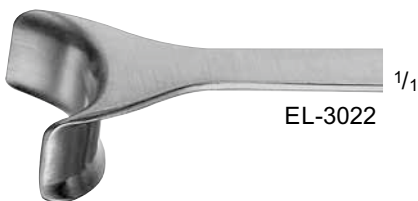

EL-3022



EL-3023



EL-3024

PARSONNET Epicardial Retractors

Catalog Number	Blade End	Tip	Length (in.)
EL-3014	3 x 3 PRONGS	SHARP	2

IMA Epicardial Retractor

Catalog Number	Blade End	Tip	Length (in.)
EL-3015	3 x 3 PRONGS	SHARP	1
EL-3016	3 x 3 PRONGS	SHARP	1 1/4
EL-3017	3 x 3 PRONGS	SHARP	1 1/2
EL-3018	3 x 3 PRONGS	SHARP	2

ROSS Aortic Valve Retractor

Catalog Number	Blade Size (mm)	Length (in.)
EL-3019	15 x 15	10
EL-3020	13 x 22	10
EL-3021	17 x 24	10
EL-3022	13 x 27	10
EL-3023	30 x 28	10
EL-3024	40 x 25	10

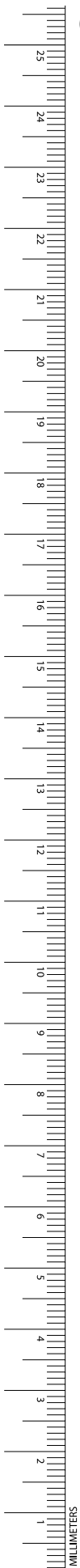



ER-3025-ER-3029

1/2

COOLEY Atrium Retractor, Left

Catalog Number	Blade Size (mm)	Length (in.)
EL-3025	25 x 20	9 5/8
EL-3026	25 x 25	9 5/8
EL-3027	25 x 30	9 5/8
EL-3028	25 x 35	9 5/8
EL-3029	25 x 45	9 5/8

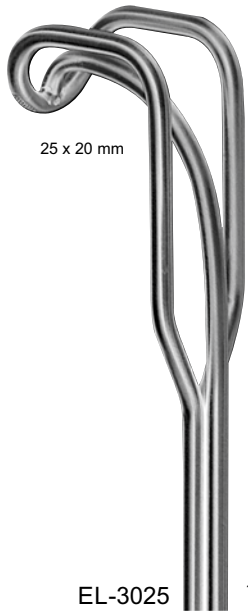

25 x 20 mm

EL-3025 1/1



25 x 25 mm

EL-3026 1/1

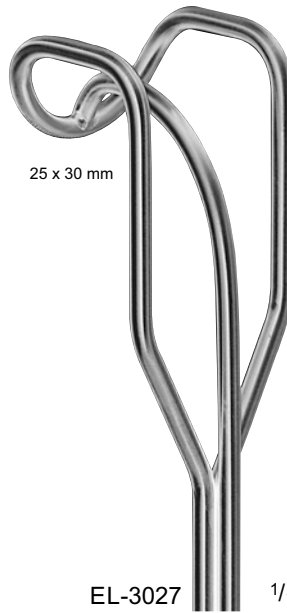

25 x 30 mm

EL-3027 1/1

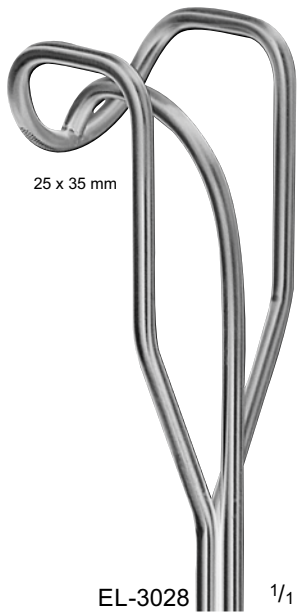

25 x 35 mm

EL-3028 1/1

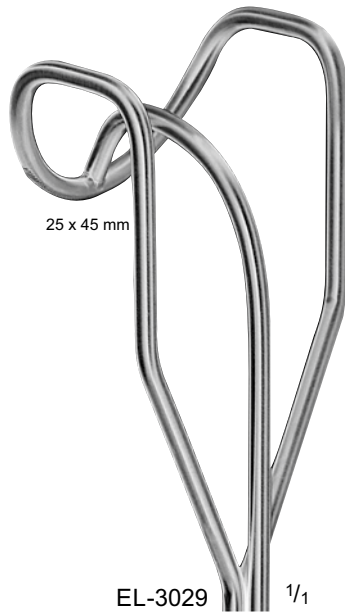

25 x 45 mm

EL-3029 1/1

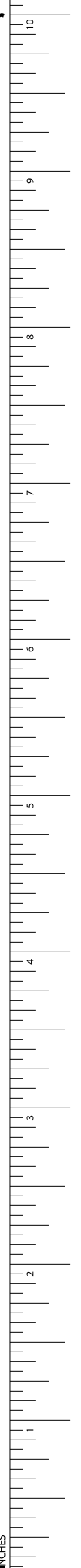

Cardiovascular Retractors

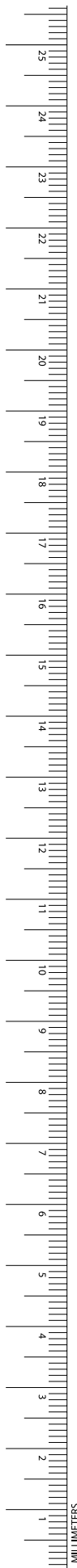

1/2

COOLEY Atrium Retractor, Right

Catalog Number	Blade Size (mm)	Length (in.)
EL-3030	25 x 20	9 1/4
EL-3031	40 x 25	9 1/4
EL-3032	40 x 30	9 1/4
EL-3033	40 x 35	9 1/4
EL-3034	40 x 45	9 1/4
EL-3035	50 x 35	9 1/4

ER-3030-ER-3035

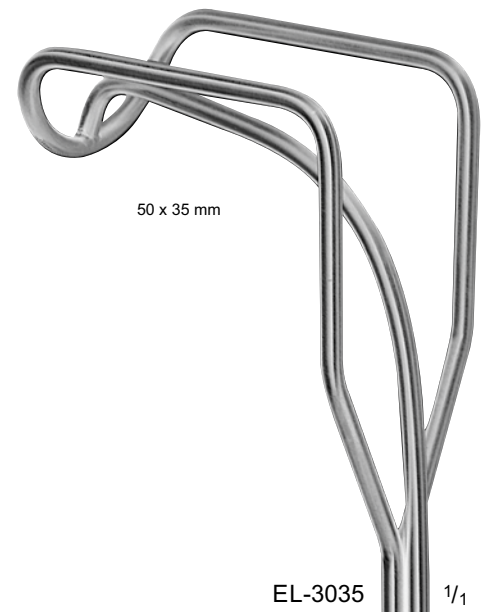
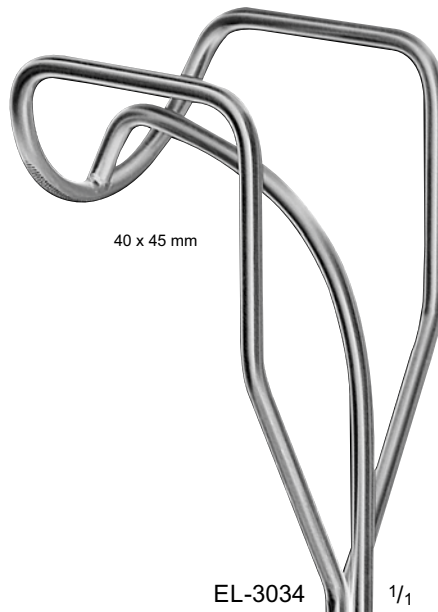
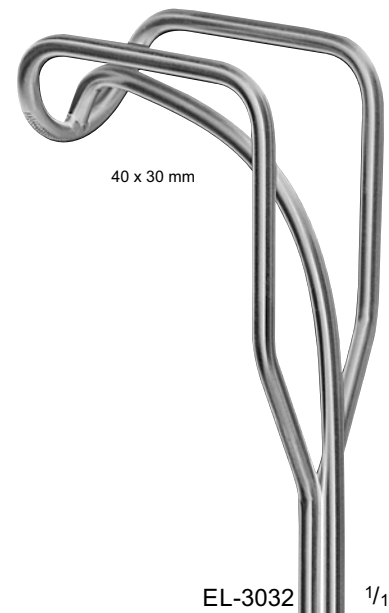
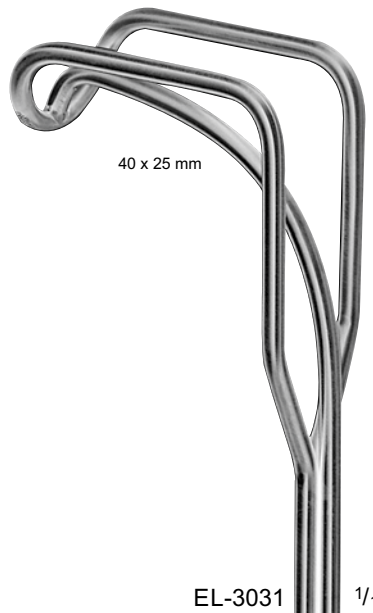
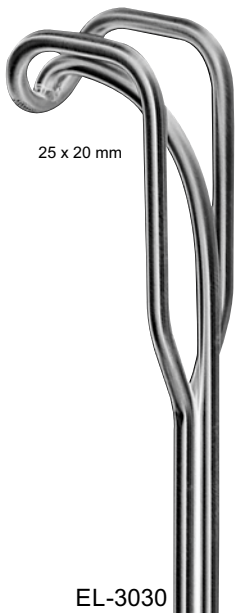

COOLEY Atrial Retractor, Right

Catalog Number	Blade Size (mm)	Length (in.)
EL-3036	22 x 19	9 1/4
EL-3037	29 x 19	9 1/4
EL-3038	38 x 38	9 1/4
EL-3039	48 x 44	9 1/4

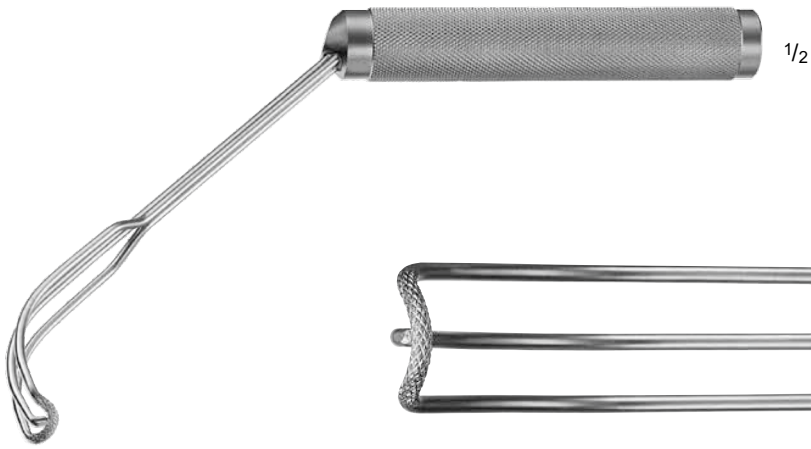

EL-3036-EL-3039

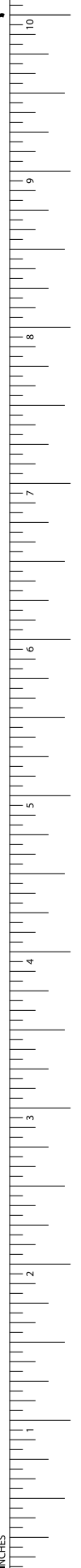
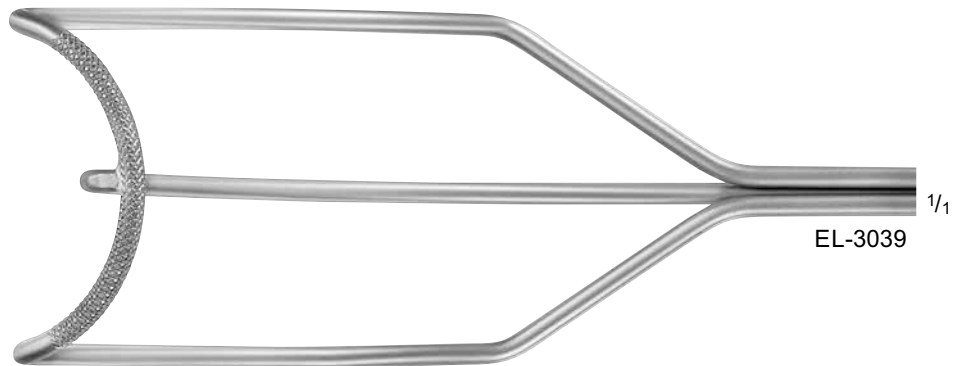
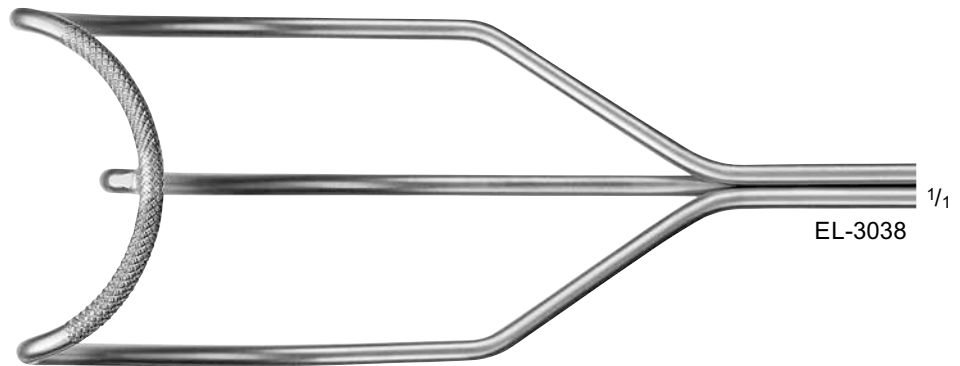
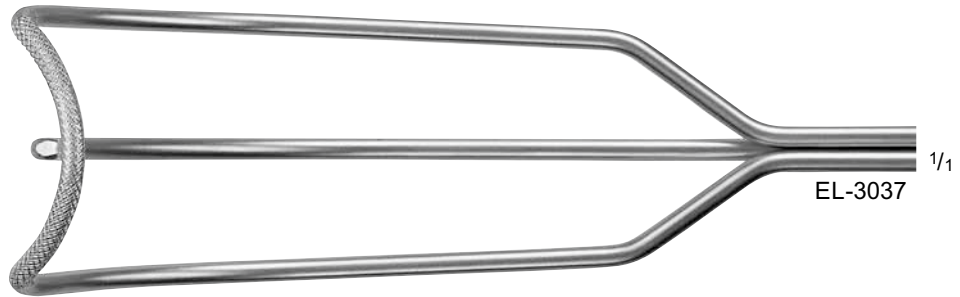
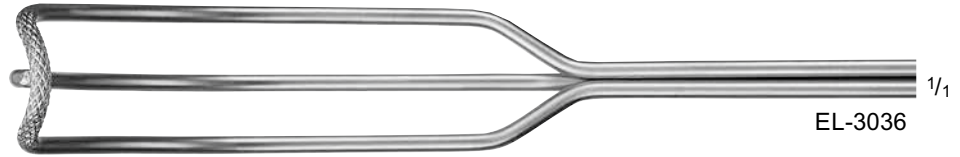

Cardiovascular Retractors

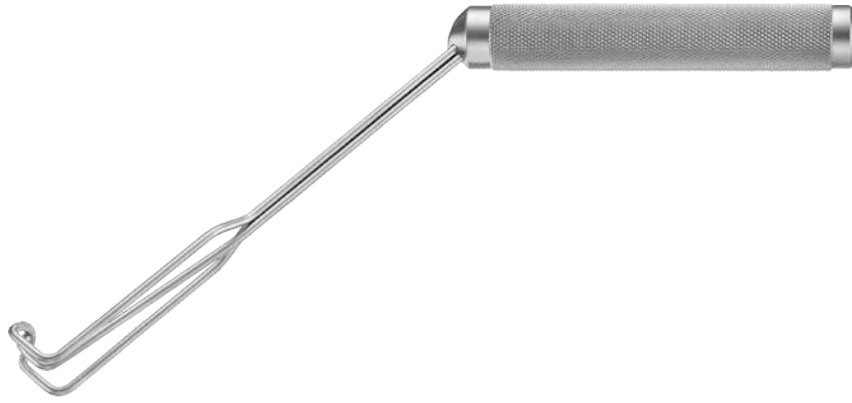
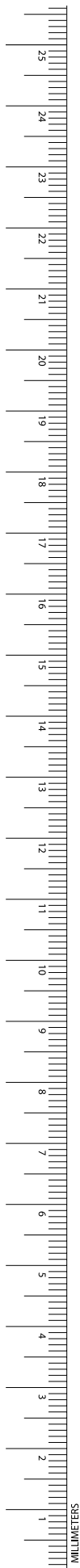

1/2

COOLEY Atrial Retractor, Left

Catalog Number	Blade Size (mm)	Length (in.)
EL-3040	19 x 38	9 1/4
EL-3041	19 x 44	9 1/4

EL-3040-EL-3041



1/1

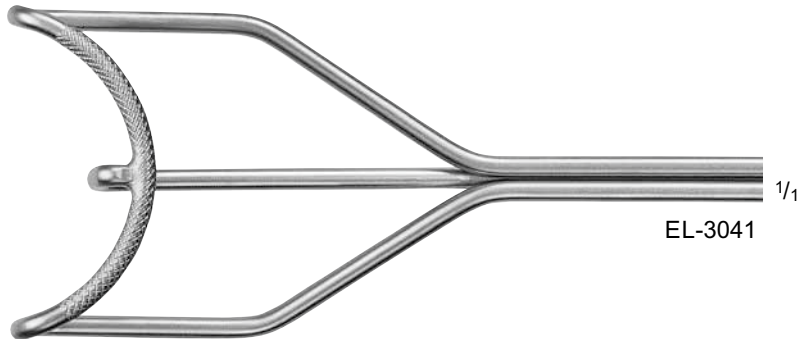

1/1

KRASKY Retractor

Catalog Number	Blade End	Tip	Blade Size (mm)	Length (in.)
EL-3042	6 PRONGS	SHARP	51 x 25	11



EL-3042



EL-3042

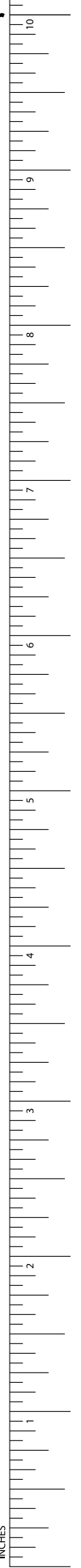

Cardiovascular Retractors

CORYLLOS Retractor

Catalog Number	Blade Size (mm)	Length (in.)
EL-3043	80 x 20	10
EL-3044	115 x 38	10
EL-3045	115 x 65	10

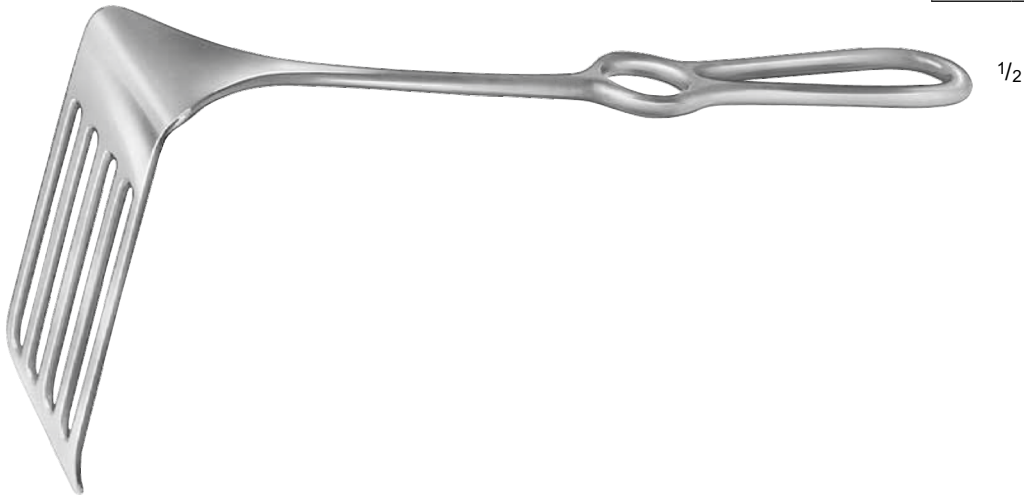

EL-3043-EL-3045

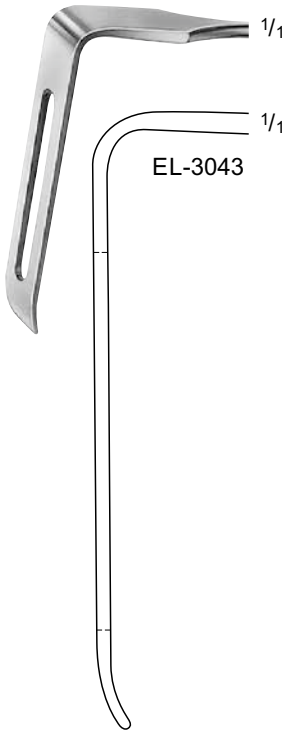

EL-3043

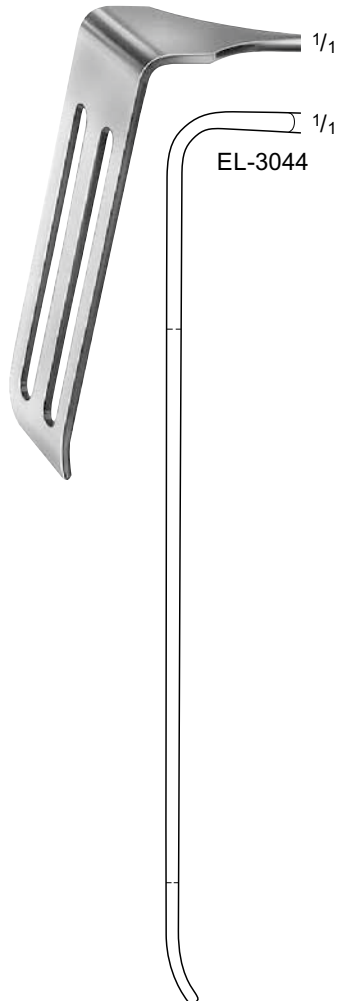

EL-3044

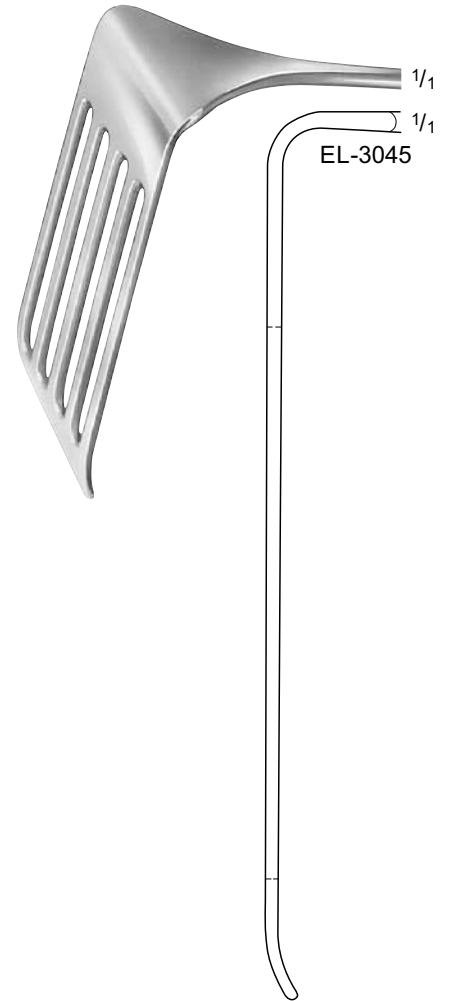

EL-3045

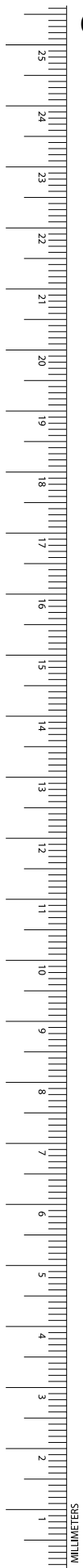

DAVIDSON Scapula Retractor

Catalog Number	Blade Size (mm)	Length (in.)
EL-3046	80 x 50	7 3/4
EL-3047	90 x 80	7 3/4

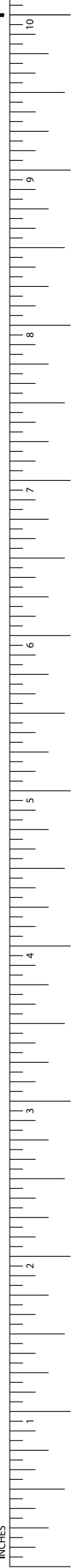
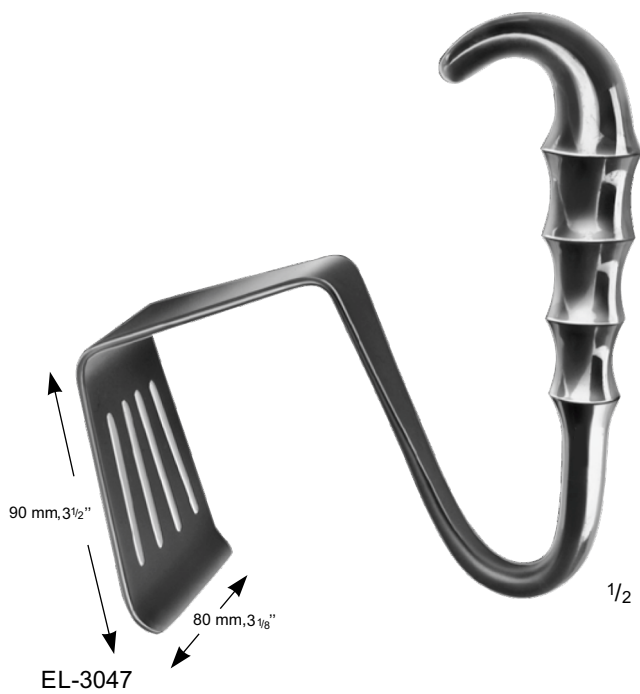
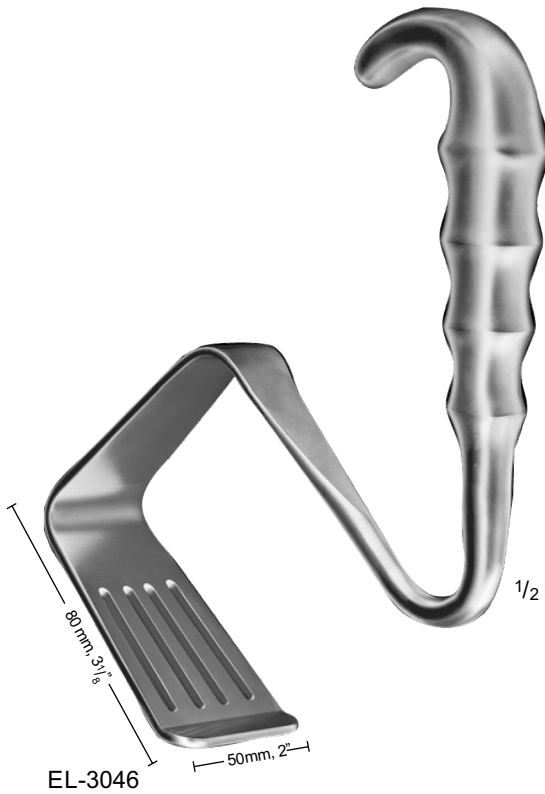

Cardiovascular Retractors

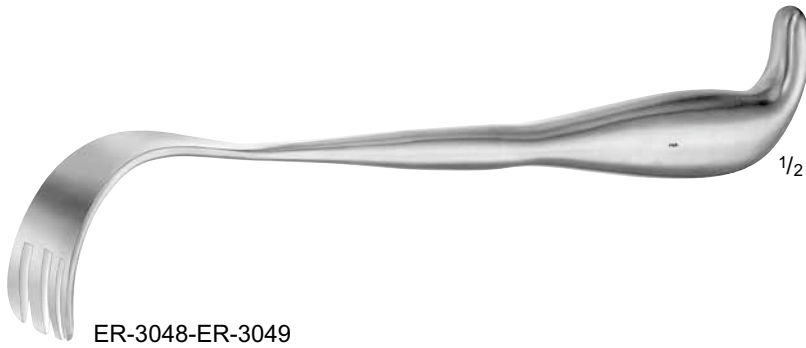

SEMB Lung Retractor

Catalog Number	Blade Size (mm)	Length (in.)
EL-3048	29 x 19	9 1/4
EL-3049	41 x 25	9 1/4



ALLISON Lung Spatula

Catalog Number	Blade Size (mm)	Length (in.)
EL-3050	40	10
EL-3051	54	12 1/2

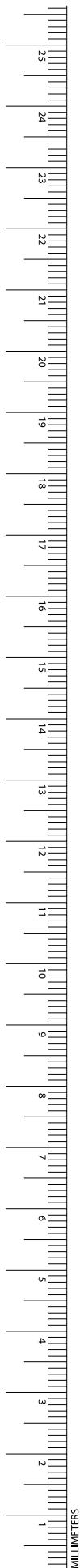

ALLISON "Sweetheart" Lung Spatula

Catalog Number	Blade Size (mm)	Length (in.)
EL-3052	137	11 3/4

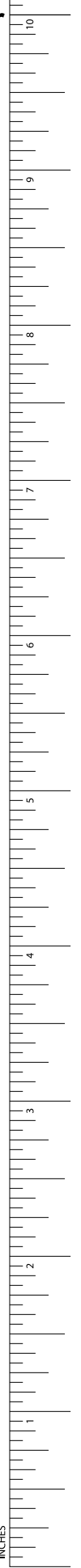
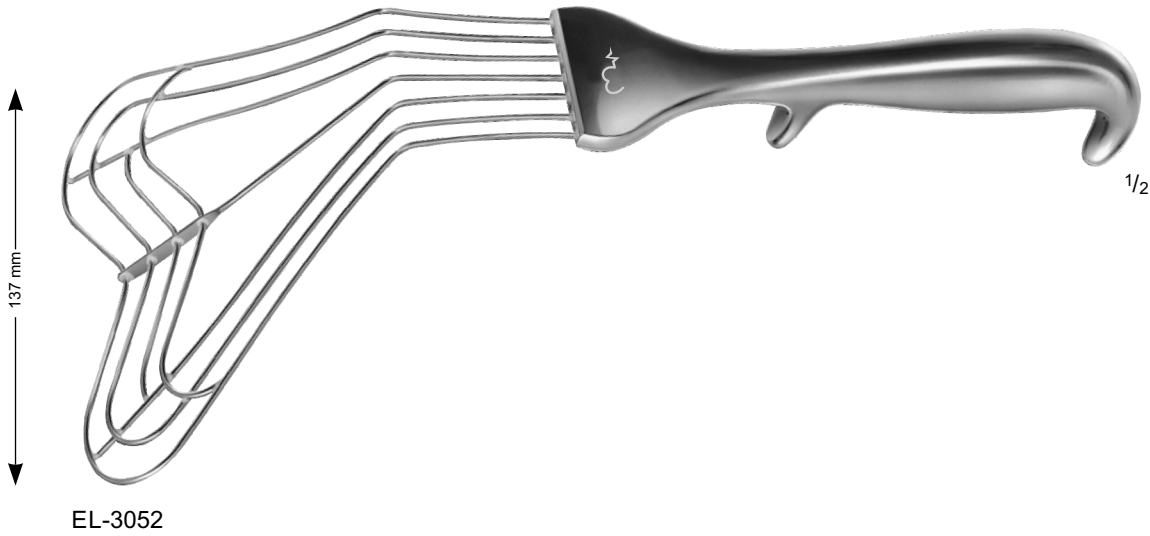

Cardiovascular Rib Spreaders

Dimensions for blade size of rib spreaders:
1st number = Depth
2nd number = Width
Example: 38 x 45 mm

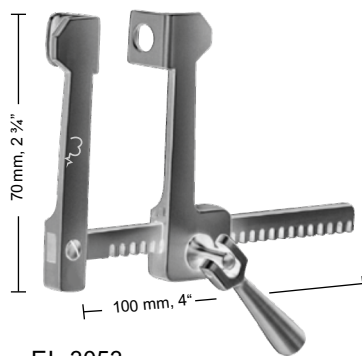
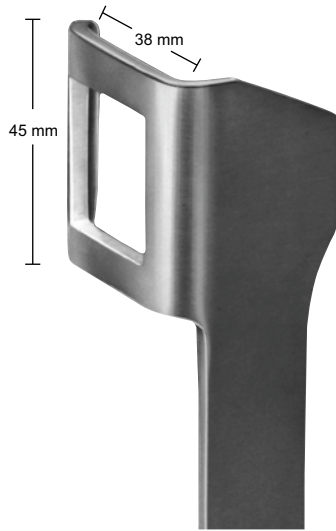

EL-3053

FINOCHIETTO Rib Spreader, Aluminum

Catalog Number	Blade Size (mm)
EL-3053	12 x 15

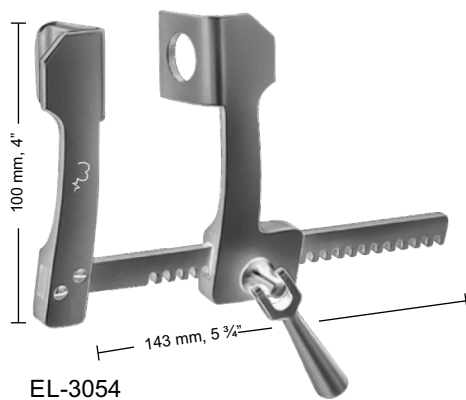

EL-3054

FINOCHIETTO-HAIGHT Rib Spreader, Aluminum

Catalog Number	Blade Size (mm)
EL-3054	28 x 30

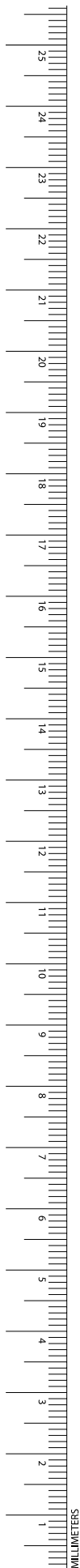



FINOCHIETTO Rib Spreader, Aluminum

Catalog Number	Blade Size (mm)
EL-3055	31 x 45

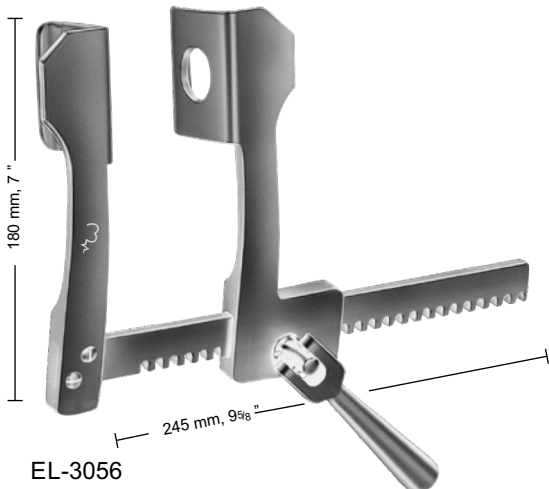

FINOCHIETTO Rib Spreader, Aluminum

Catalog Number	Blade Size (mm)
EL-3056	42 x 61

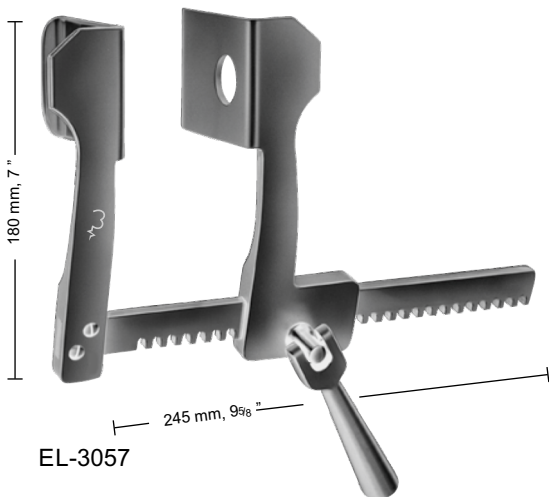

FINOCHIETTO Rib Spreader, Aluminum

Catalog Number	Blade Size (mm)
EL-3057	74 x 64

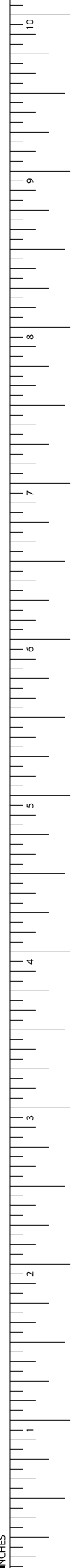

Cardiovascular Rib Spreaders

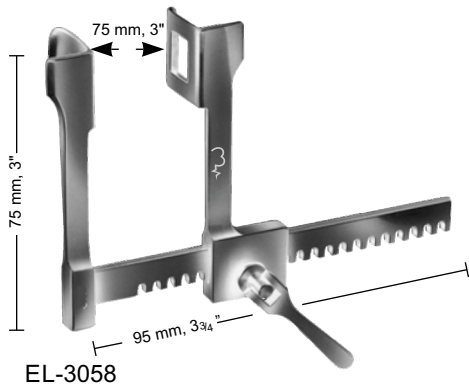
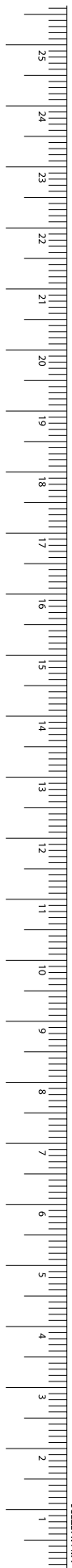

FINOCHIETTO Rib Spreader, Infant

Catalog Number	Blade Size (mm)
EL-3058	18 x 21

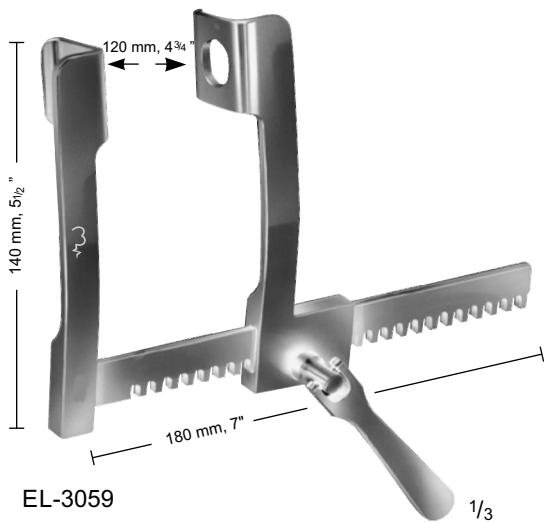

FINOCHIETTO Rib Spreader, Pediatric

Catalog Number	Blade Size (mm)
EL-3059	28 x 32

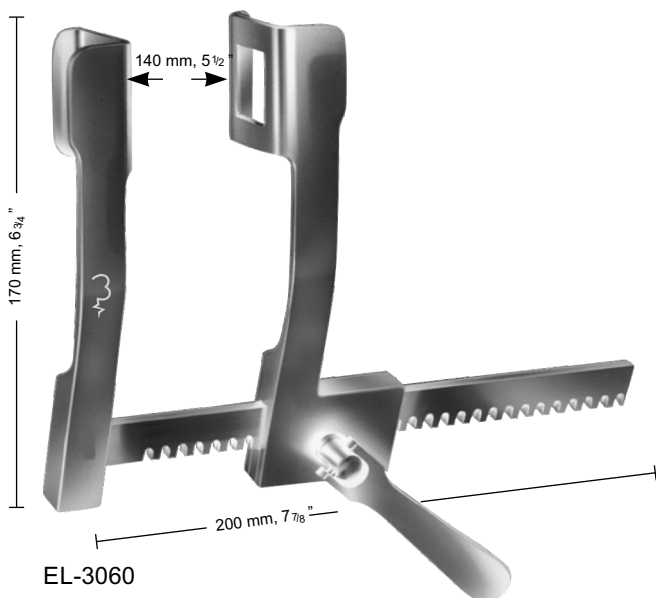

FINOCHIETTO Rib Spreader, Small Adult

Catalog Number	Blade Size (mm)
EL-3060	36 x 45

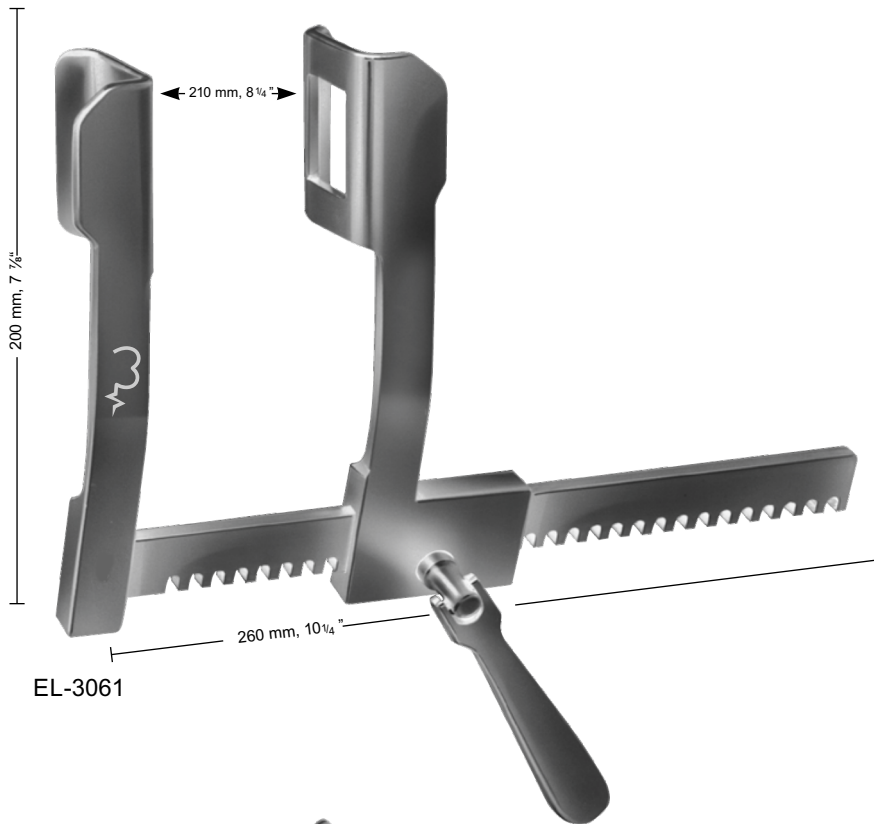

FINOCHIETTO Rib Spreader, Adult

Catalog Number	Blade Size (mm)
EL-3061	44 x 65
EL-3062	65 x 65

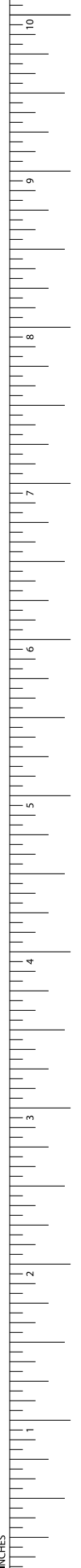
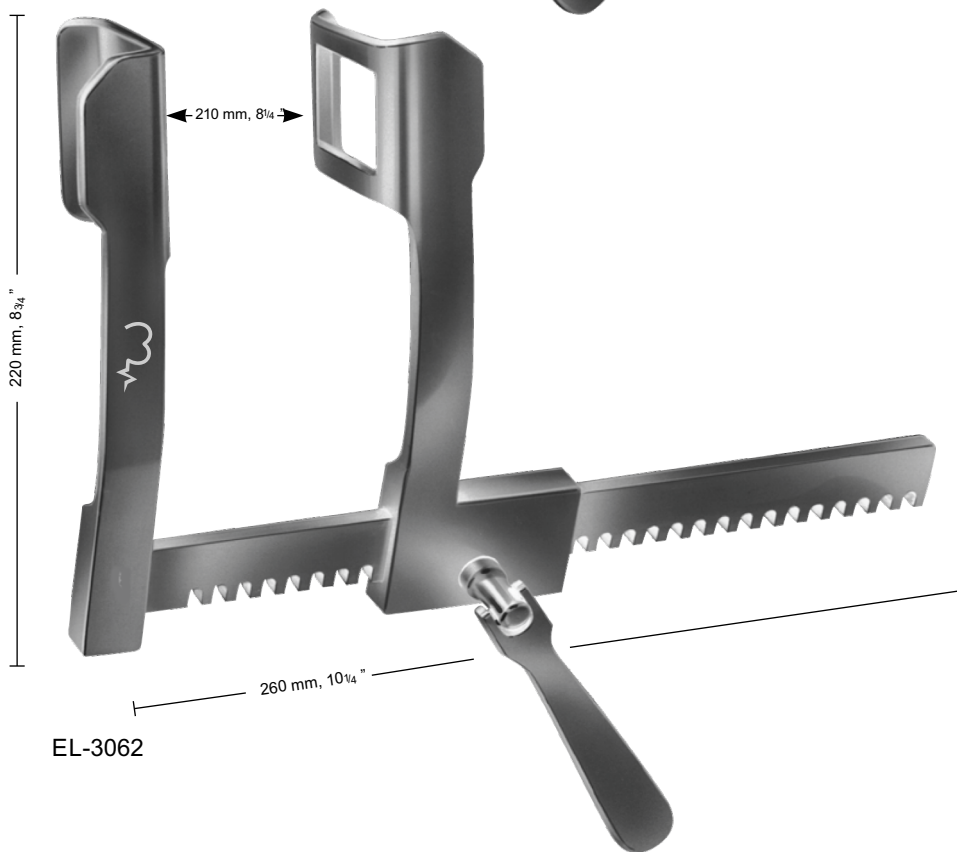

Cardiovascular Rib Spreaders

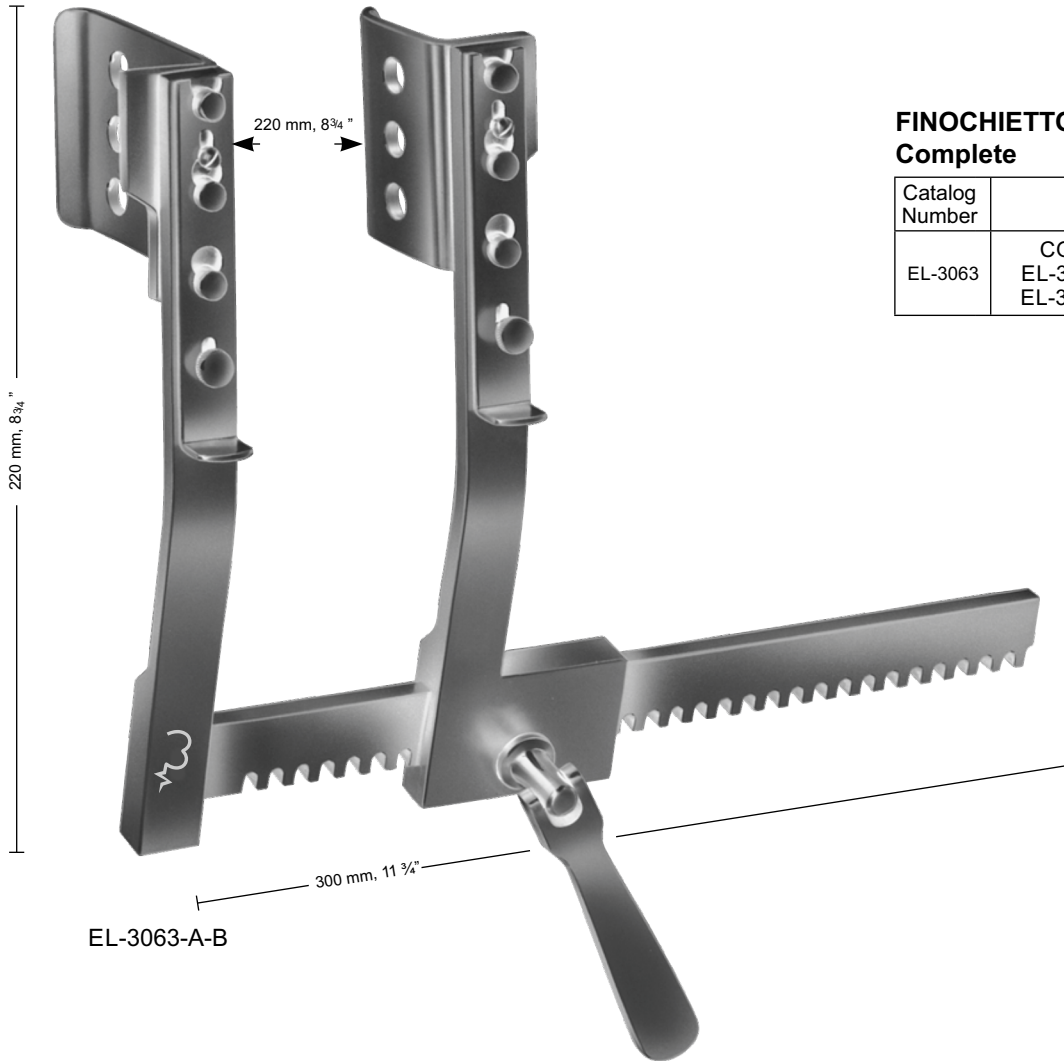
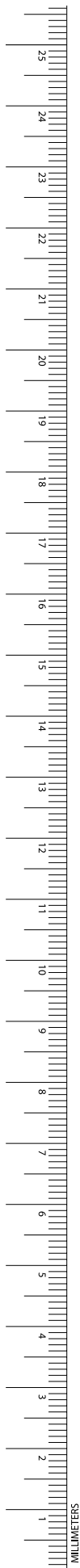

FINOCHIETTO-BURFORD Rib Spreader, Complete

Catalog Number	Description
EL-3063	COMPLETE, W/ BLADES EL-3063-A (45 MM x 64 MM) EL-3063-B (75 MM x 64 MM)

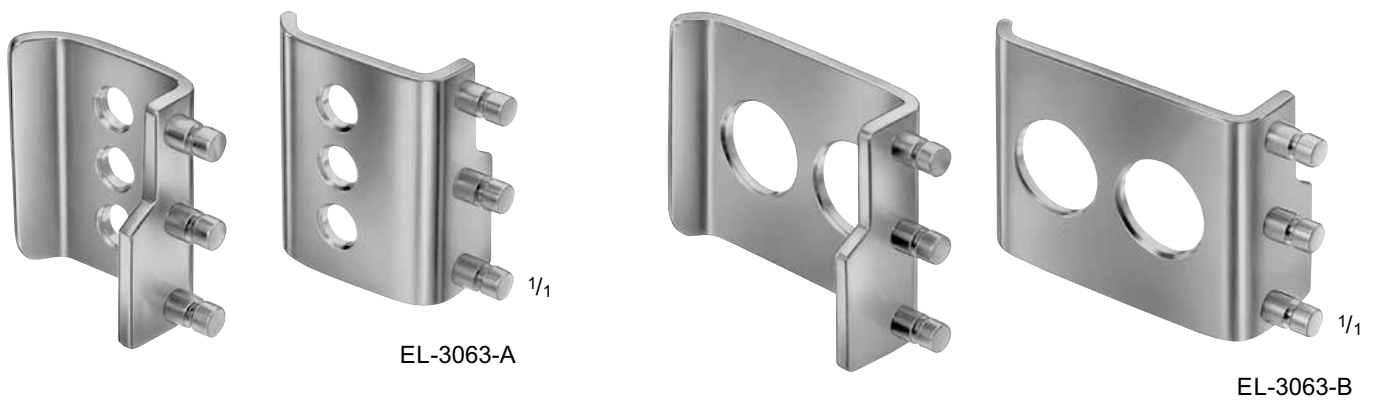

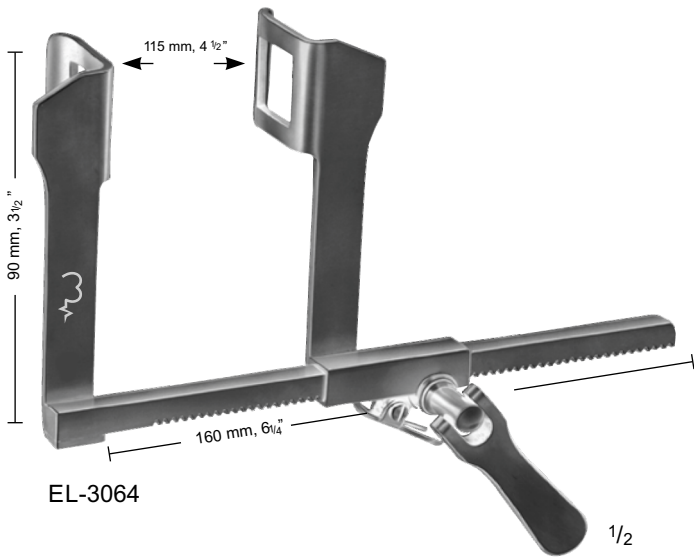

HAIGHT Rib Spreader

Catalog Number	Blade Size (mm)
EL-3064	30 x 30

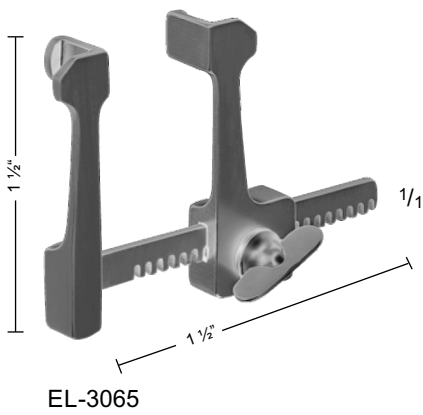

Rib Spreader, Premie

Catalog Number	Blade Size (mm)	Description
EL-3065	7 x 7	SPREAD 1 1/2", ARM LENGTH 1 1/2"



Cardiovascular Rib Spreaders

TUFFIER Rib Spreader

Catalog Number	Blade Size (mm)	Blade End
EL-3066	43 x 53	RIBBED
EL-3067	45 x 47	SERR

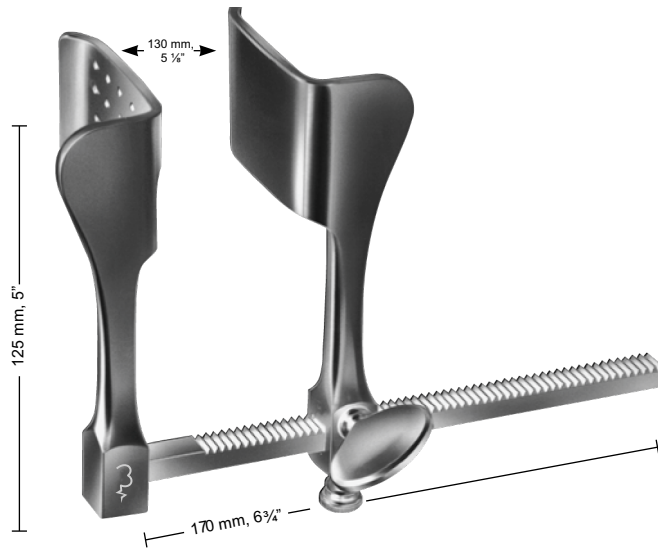

EL-3066

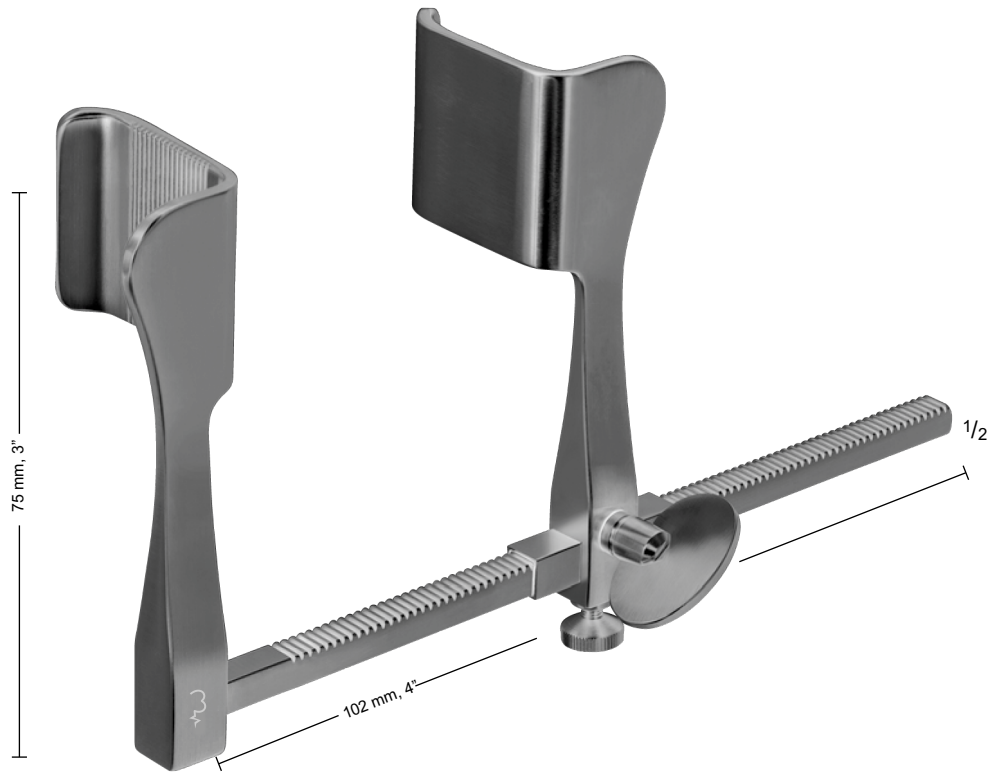

EL-3067

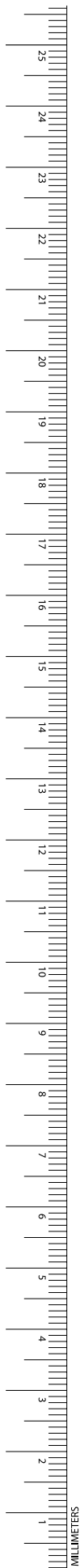



EL-3068

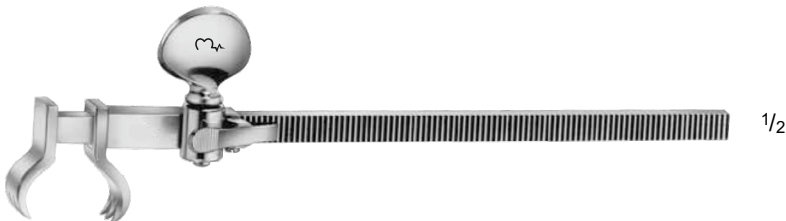
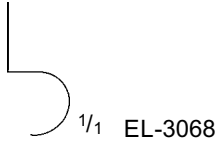

EL-3069-EL-3070



EL-3069



EL-3069



EL-3070

BAILEY Rib Contractor

Catalog Number	Description	Length (in.)
EL-3068	PEDIATRIC	6
EL-3069	SMALL ADULT	7 7/8
EL-3070	ADULT	7 7/8

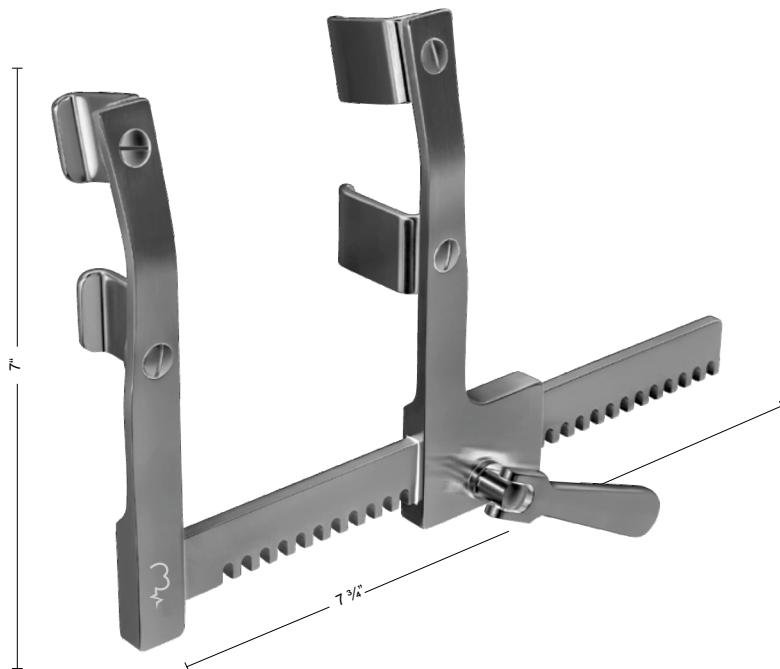

EL-3071

FAVALORO-MORSE Sternal Retractor

Catalog Number	Blade Size (mm)
EL-3071	40 x 29

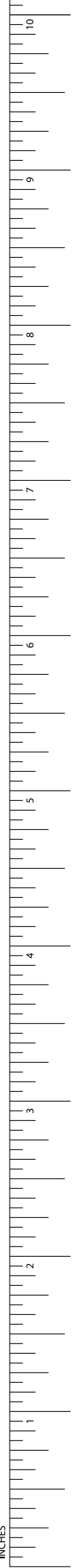

Cardiovascular Rib Spreaders

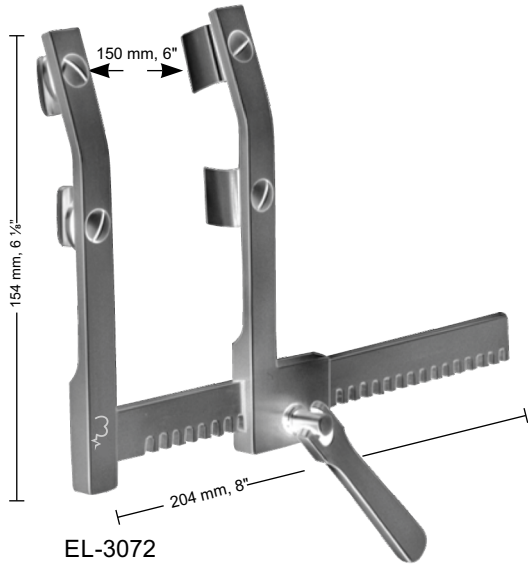

EL-3072

MORSE Sternotomy Retractor, Pediatric

Catalog Number	Blade Size (mm)
EL-3072	12 x 20

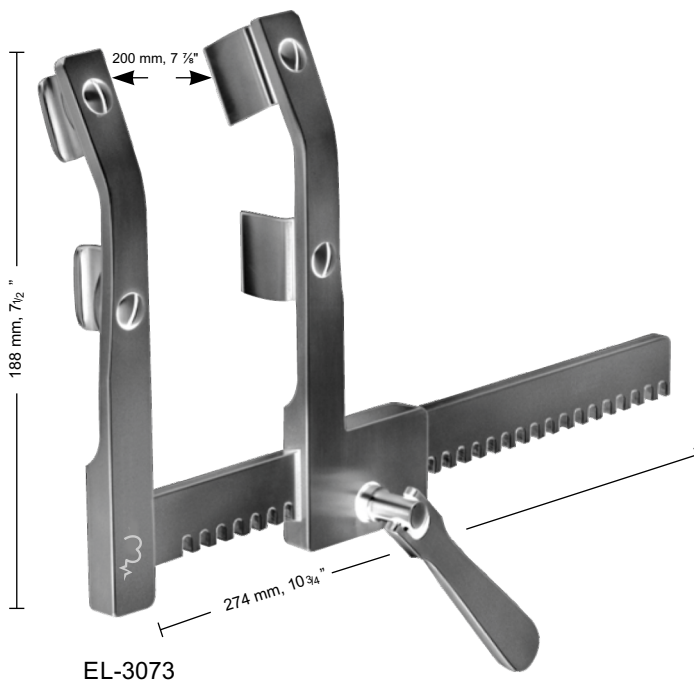

EL-3073

MORSE Sternotomy Retractor, Adult

Catalog Number	Blade Size (mm)
EL-3073	19 x 29

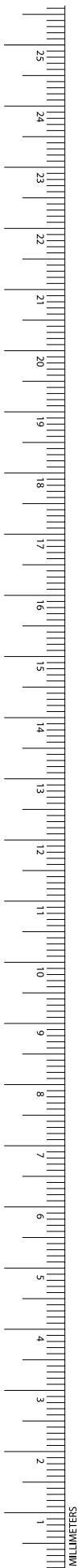

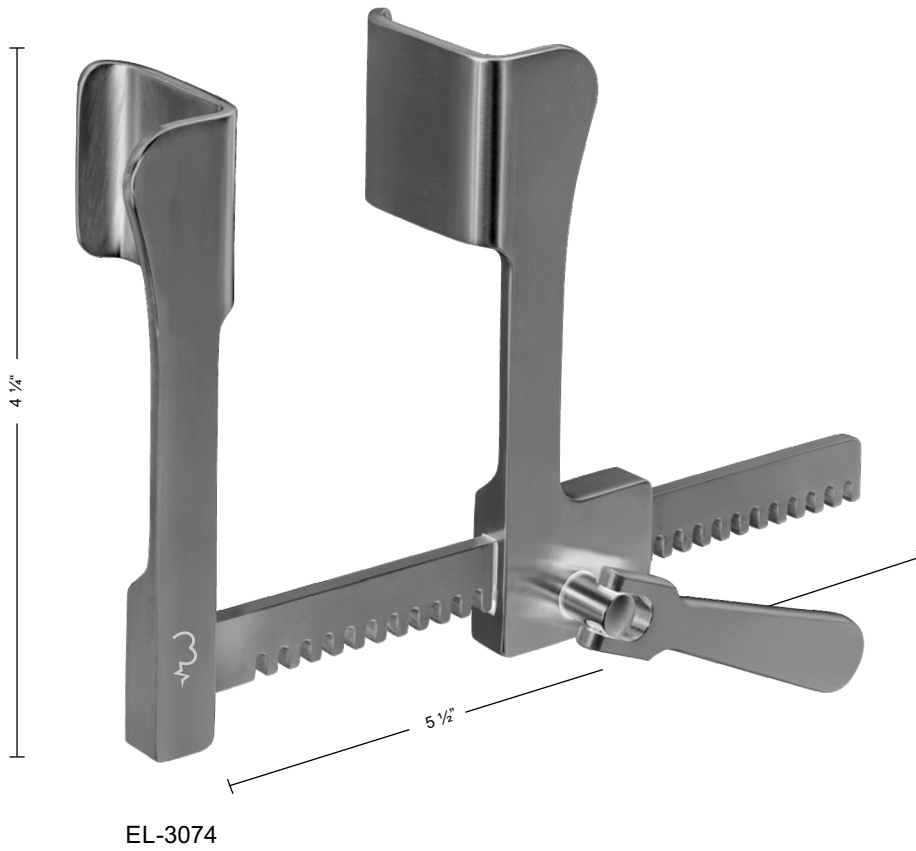

REINHOFF Rib Spreader

Catalog Number	Blade Size (mm)
EL-3074	45 x 50



Cardiovascular Rib Spreaders

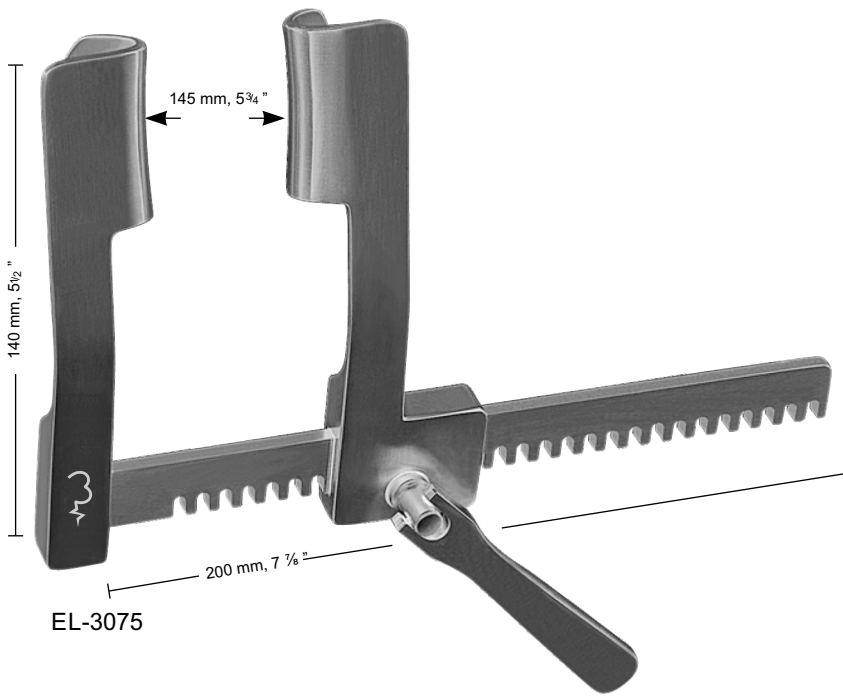
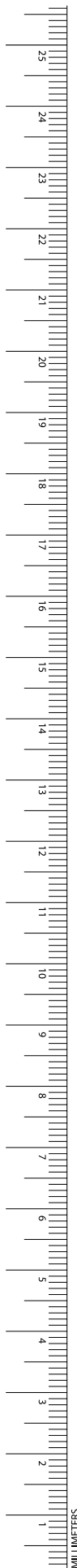

COOLEY Sternotomy Spreader, Pediatric

Catalog Number	Blade Size (mm)
EL-3075	21 x 45



EL-3075

COOLEY Sternotomy Spreader, Adult

Catalog Number	Blade Size (mm)
EL-3076	32 x 50

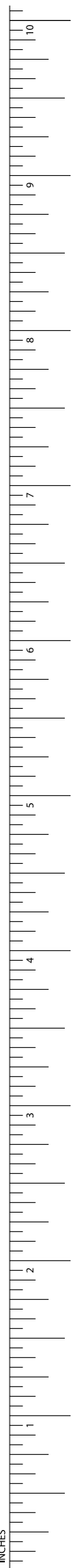
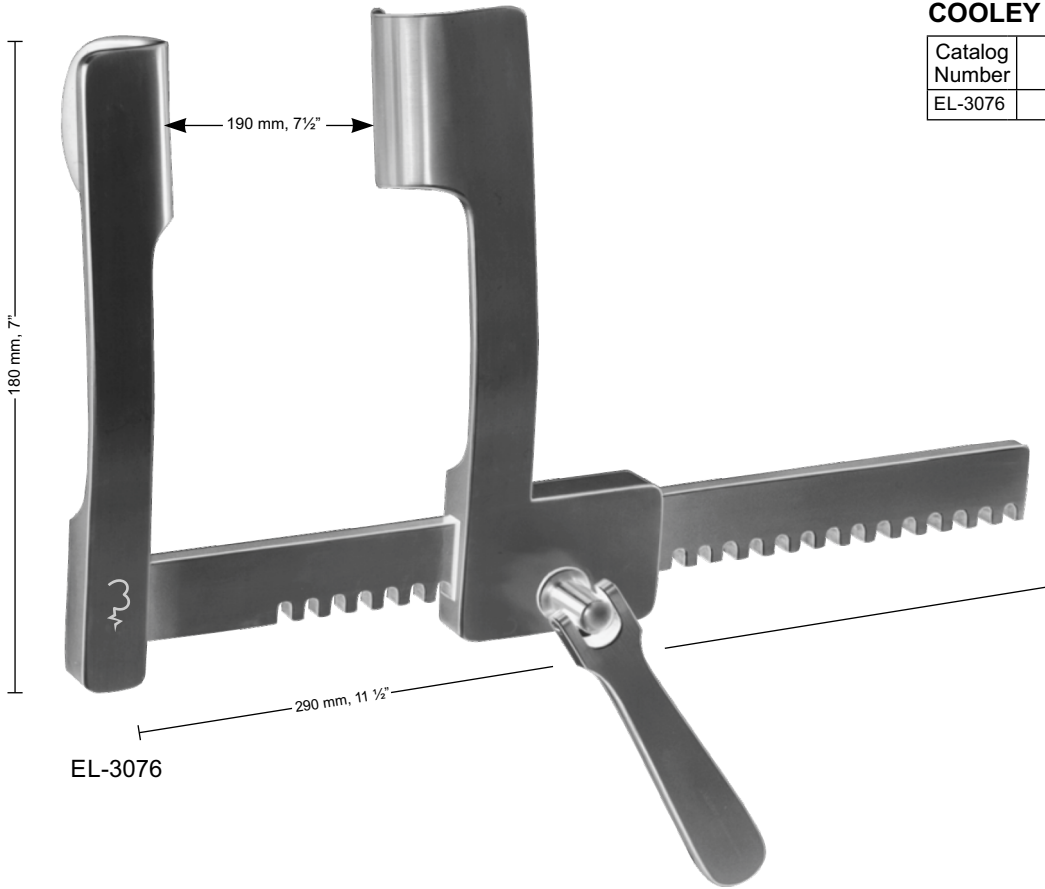

Cardiovascular Rib Spreaders

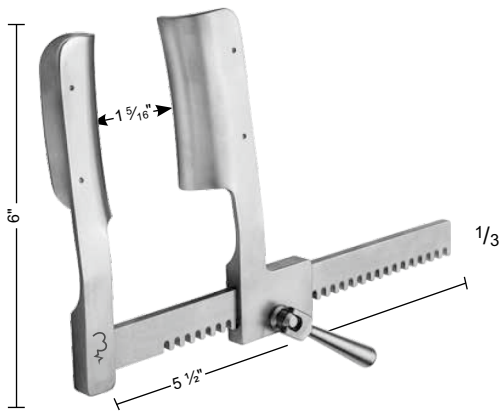
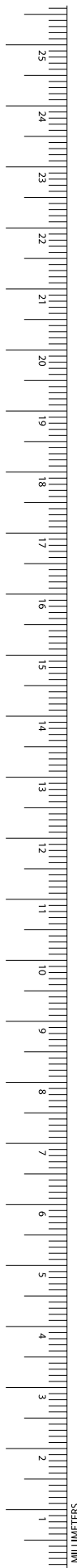

EL-3077



EL-3077

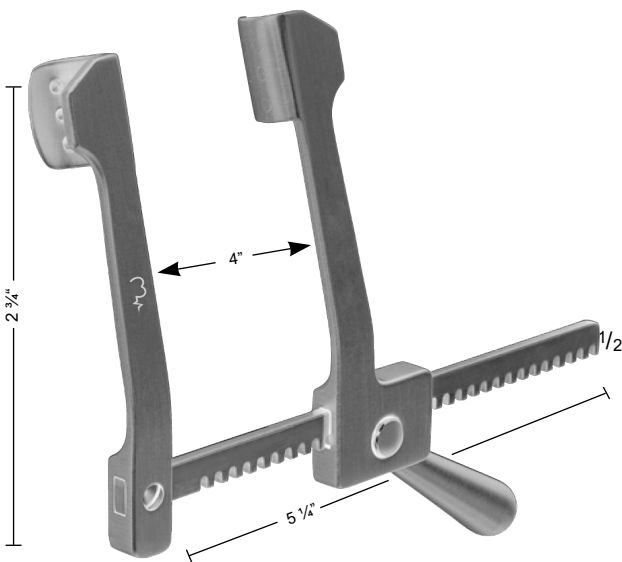

EL-3078

COOLEY Sternotomy Spreader, Extra Large

Catalog Number	Blade Size (mm)
EL-3077	35 x 100

COOLEY Sternal Retractor, Aluminum, Pediatric

Catalog Number	Blade Size (mm)
EL-3078	17 x 19 W/ PINS

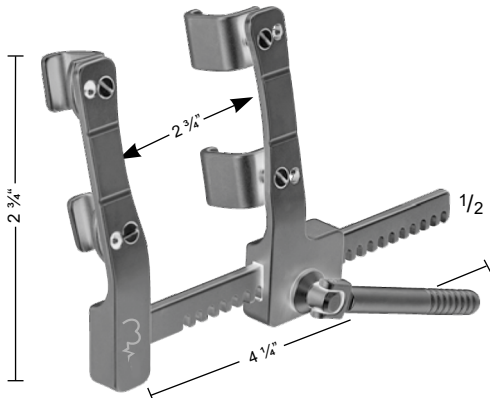

EL-3079

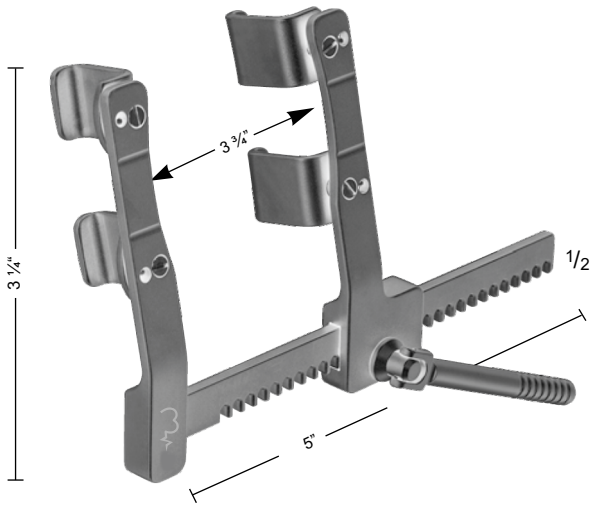

EL-3080

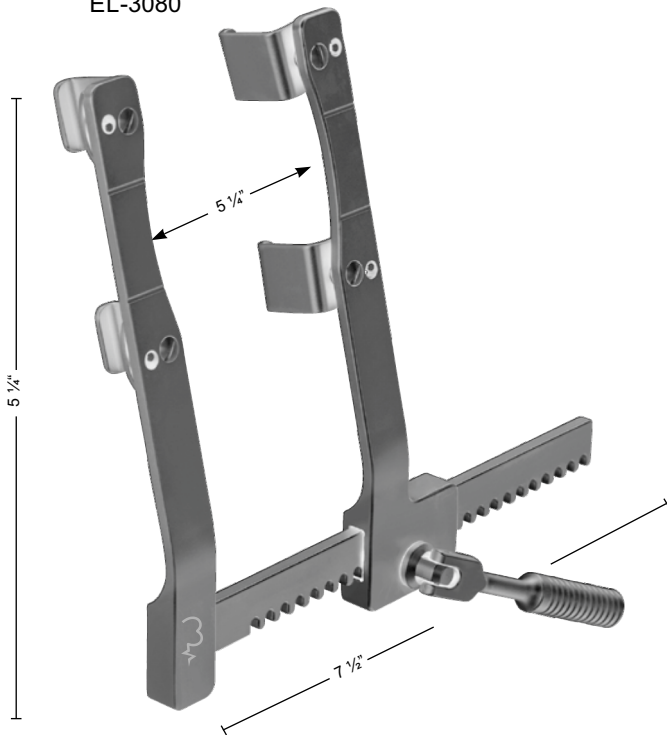

EL-3081

Sternal Retractor

Catalog Number	Blade Size (mm)	Description
EL-3079	12 x 10	DOUBLE BLADES 12 x 10 MM
EL-3080	14 x 14	DOUBLE BLADE 14 x 14 MM
EL-3081	20 x 19	DOUBLE BLADE 20 x 19 MM

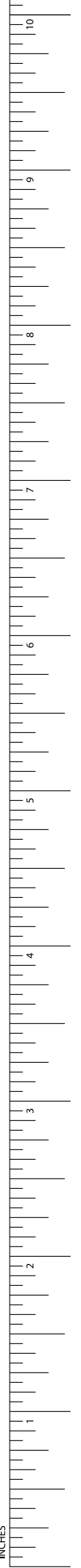

Cardiovascular
Rib Spreaders

CHAUX Sternal Retractor

Catalog Number	Blade Size (mm)	Description
EL-3082	27 x 30	ROTATION FOR IMA EXPOSURE

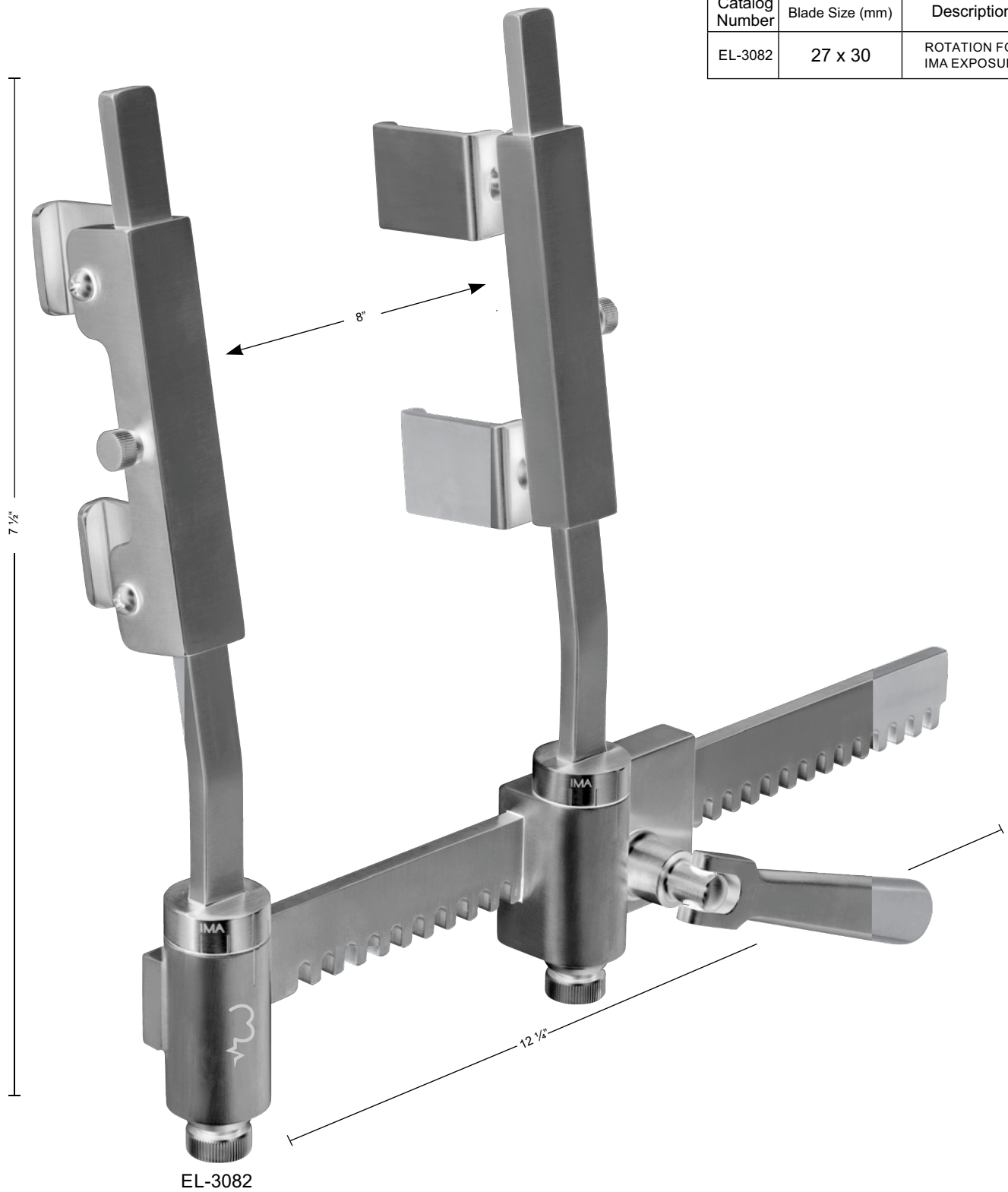
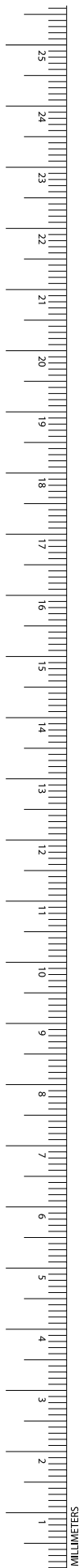

EL-3082

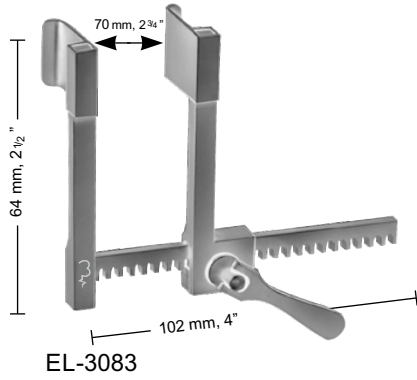

STRUCK Rib Spreader, Infant

Catalog Number	Description
EL-3083	COMPLETE
EL-3084	SPREADER ONLY, 64 x 92 MM
EL-3085	OPT. BLADES, 10 x 10 MM, 2/SET
EL-3086	OPT. BLADES, 10 x 15 MM, 2/SET
EL-3087	OPT. BLADES, 10 x 20 MM, 2/SET
EL-3088	BLADES, 15 x 20 MM, 2/SET
EL-3089	BLADES, 20 x 20 MM, 2/SET





All rights reserved. Technical alterations are possible. This leaflet may be used for no other purposes than offering, buying and selling of our products. No part may be copied or reproduced in any form. In the case of misuse, we retain the rights to recall our catalogues and price lists and to take legal actions.